

# **Voyager™ 1450g/1452g/1450g2DHR Series**

---

Area-Imaging Scanner

## **User's Guide**

---

## ***Disclaimer***

Honeywell International Inc. ("HII") reserves the right to make changes in specifications and other information contained in this document without prior notice, and the reader should in all cases consult HII to determine whether any such changes have been made. The information in this publication does not represent a commitment on the part of HII.

HII shall not be liable for technical or editorial errors or omissions contained herein; nor for incidental or consequential damages resulting from the furnishing, performance, or use of this material. HII disclaims all responsibility for the selection and use of software and/or hardware to achieve intended results.

This document contains proprietary information that is protected by copyright. All rights are reserved. No part of this document may be photocopied, reproduced, or translated into another language without the prior written consent of HII.

Copyright © 2014-2015 Honeywell International Inc. All rights reserved.

Web Address: [www.honeywellaidc.com](http://www.honeywellaidc.com)

Microsoft® Windows® is a trademark or registered trademark of Microsoft Corporation.

Other product names or marks mentioned in this document may be trademarks or registered trademarks of other companies and are the property of their respective owners.

For patent information, please refer to [www.hsmpats.com](http://www.hsmpats.com).

---



# Table of Contents

## **Customer Support**

Technical Assistance .....	ix
Product Service and Repair .....	ix
Limited Warranty .....	ix
Send Feedback .....	ix

## **Chapter 1 - Getting Started**

About This Manual .....	1-1
Unpacking Your Device .....	1-1
Connecting the Device .....	1-1
Connecting with USB .....	1-1
Connecting with Keyboard Wedge .....	1-3
Connecting with RS232 Serial Port .....	1-4
Connecting with RS485 .....	1-5
Mounting a CCB01-010BT Charge Base .....	1-6
Reading Techniques .....	1-6
Menu Bar Code Security Settings .....	1-6
Setting Custom Defaults .....	1-7
Resetting the Custom Defaults .....	1-7

## **Chapter 2 - Programming the Interface**

Introduction .....	2-1
Programming the Interface - Plug and Play .....	2-1
Keyboard Wedge .....	2-1
Laptop Direct Connect .....	2-1
RS232 Serial Port .....	2-1
RS485 .....	2-2
RS485 Packet Mode .....	2-2
USB IBM SurePos .....	2-3
USB PC or Macintosh Keyboard .....	2-3
USB HID .....	2-4
USB Serial .....	2-4
CTS/RTS Emulation .....	2-4
ACK/NAK Mode .....	2-4
Remote MasterMind™ for USB .....	2-5
Verifone® Ruby Terminal Default Settings .....	2-5
Gilbarco® Terminal Default Settings .....	2-5
Honeywell Bioptic Aux Port Configuration .....	2-6
Datalogic™ Magellan® Bioptic Aux Port Configuration .....	2-6
NCR Bioptic Aux Port Configuration .....	2-6
Wincor Nixdorf Terminal Default Settings .....	2-6
Wincor Nixdorf Beetle™ Terminal Default Settings .....	2-7
Wincor Nixdorf RS232 Mode A .....	2-7
Keyboard Country Layout .....	2-8
Keyboard Style .....	2-15
Keyboard Conversion .....	2-16

---

Control Character Output .....	2-17
Keyboard Modifiers.....	2-17
RS232 Modifiers.....	2-18
RS232 Baud Rate.....	2-18
RS232 Word Length: Data Bits, Stop Bits, and Parity.....	2-19
RS232 Receiver Time-Out.....	2-20
RS232 Handshaking.....	2-20
RS232 Timeout.....	2-21
XON/XOFF .....	2-21
ACK/NAK.....	2-22
Scanner to Bioptic Communication .....	2-22
Scanner-Biopic Packet Mode .....	2-22
Scanner-Biopic ACK/NAK Mode.....	2-22
Scanner-Biopic ACK/NAK Timeout.....	2-23

### **Chapter 3 - Cordless System Operation**

How the Cordless Charge Base/Access Point Works .....	3-1
Linking the Scanner to a Charge Base.....	3-1
Linking the Scanner to an Access Point .....	3-1
Replacing a Linked Scanner.....	3-2
Communication Between the Cordless System and the Host.....	3-2
Programming the Scanner and Base or Access Point .....	3-3
RF (Radio Frequency) Module Operation .....	3-3
System Conditions.....	3-3
Linking Process .....	3-3
Scanner Is Out of Range .....	3-3
Scanner Is Moved Back Into Range .....	3-3
Out of Range and Back into Range with Batch Mode On.....	3-3
Page Button.....	3-3
About the Battery.....	3-4
Charging Information .....	3-4
Battery Recommendations .....	3-4
Proper Disposal of the Battery.....	3-4
Beeper and LED Sequences and Meaning .....	3-5
Scanner LED Sequences and Meaning.....	3-5
Base/Access Point LED Sequences and Meaning.....	3-5
Base Power Communication Indicator.....	3-5
Reset Scanner.....	3-6
Scanning While in Base Cradle .....	3-6
Base Charging Modes .....	3-6
Paging .....	3-7
Paging Mode.....	3-7
Paging Pitch.....	3-7
Error Indicators .....	3-8
Beeper Pitch - Base Error.....	3-8
Number of Beeps - Base Error .....	3-8
Scanner Report .....	3-8

---

Scanner Address .....	3-9
Base or Access Point Address .....	3-9
Scanner Modes .....	3-9
Charge Only Mode.....	3-9
Linked Modes .....	3-9
Unlinking the Scanner .....	3-10
Override Locked Scanner .....	3-10
Out-of-Range Alarm .....	3-10
Alarm Sound Type.....	3-11
Scanner Power Time-Out Timer.....	3-11
Flexible Power Management .....	3-12
Batch Mode .....	3-13
Batch Mode Beep .....	3-14
Batch Mode Storage .....	3-14
Batch Mode Quantity .....	3-15
Batch Mode Output Order.....	3-16
Total Records .....	3-17
Delete Last Code .....	3-17
Clear All Codes.....	3-17
Transmit Records to Host.....	3-17
Batch Mode Transmit Delay .....	3-17
Multiple Scanner Operation .....	3-18
Scanner Name.....	3-18
Application Work Groups.....	3-19
Application Work Group Selection .....	3-20
Resetting the Factory Defaults: All Application Work Groups .....	3-20
Resetting the Custom Defaults: All Application Work Groups .....	3-21
Pairing the Scanner with Bluetooth Devices.....	3-21
Virtual Keyboard .....	3-22
Bluetooth HID Keyboard Disconnect .....	3-23
Bluetooth Serial Port - PCs/Laptops .....	3-23
PDAs/Mobility Systems Devices.....	3-23
Changing the Scanner's Bluetooth PIN Code.....	3-23
Minimizing Bluetooth/ISM Band Network Activity .....	3-23
Auto Reconnect Mode .....	3-24
Maximum Link Attempts .....	3-24
Relink Time-Out.....	3-25
Bluetooth/ISM Network Activity Examples.....	3-25
Host Acknowledgment.....	3-26
Host ACK Timeout.....	3-27

## **Chapter 4 - Input/Output Settings**

Power Up Beeper .....	4-1
Beep on BEL Character.....	4-1
Trigger Click .....	4-1

---

Good Read and Error Indicators.....	4-2
Beeper – Good Read.....	4-2
Beeper Volume – Good Read.....	4-2
Beeper Pitch – Good Read.....	4-2
Beeper Pitch – Error .....	4-3
Beeper Duration – Good Read .....	4-3
LED – Good Read .....	4-3
Number of Beeps – Good Read .....	4-4
Number of Beeps – Error.....	4-4
Good Read Delay .....	4-4
User-Specified Good Read Delay.....	4-4
Manual Trigger Mode .....	4-5
LED Illumination - Manual Trigger .....	4-5
Serial Trigger Mode .....	4-5
Read Time-Out .....	4-5
Presentation Mode .....	4-6
Idle Illumination - Presentation Mode .....	4-6
Presentation Sensitivity .....	4-6
Presentation Centering.....	4-6
In-Stand Sensor Mode.....	4-8
Poor Quality Codes .....	4-8
Poor Quality 1D Codes.....	4-8
Poor Quality PDF Codes .....	4-9
CodeGate® .....	4-9
Mobile Phone Read Mode .....	4-9
Hands Free Time-Out.....	4-9
Reread Delay.....	4-10
User-Specified Reread Delay .....	4-10
2D Reread Delay .....	4-10
Character Activation Mode .....	4-11
Activation Character .....	4-11
End Character Activation After Good Read .....	4-12
Character Activation Timeout .....	4-12
Character Deactivation Mode .....	4-12
Deactivation Character .....	4-12
Illumination Lights.....	4-13
Aimer Delay .....	4-13
User-Specified Aimer Delay.....	4-13
Aimer Mode .....	4-13
Centering.....	4-14
No Read .....	4-15
Video Reverse .....	4-16
Working Orientation.....	4-16

---

## **Chapter 5 - Data Editing**

Prefix/Suffix Overview .....	5-1
To Add a Prefix or Suffix:.....	5-1
To Clear One or All Prefixes or Suffixes.....	5-2
To Add a Carriage Return Suffix to All Symbologies.....	5-2
Prefix Selections.....	5-2
Suffix Selections.....	5-2
Function Code Transmit.....	5-3
Intercharacter, Interfunction, and Intermessage Delays.....	5-3
Intercharacter Delay.....	5-3
User Specified Intercharacter Delay.....	5-3
Interfunction Delay.....	5-4
Intermessage Delay.....	5-4

## **Chapter 6 - Data Formatting**

Data Format Editor Introduction .....	6-1
Add a Data Format.....	6-1
Other Programming Selections.....	6-2
Terminal ID Table.....	6-3
Data Format Editor Commands.....	6-3
Move Commands.....	6-4
Search Commands.....	6-5
Miscellaneous Commands.....	6-7
Data Formatter .....	6-9
Primary/Alternate Data Formats.....	6-9

## **Chapter 7 - Symbologies**

All Symbologies.....	7-1
Message Length Description.....	7-1
Codabar.....	7-2
Codabar Concatenation.....	7-3
Code 39.....	7-4
Code 32 Pharmaceutical (PARAF).....	7-5
Full ASCII.....	7-6
Code 39 Code Page.....	7-6
Interleaved 2 of 5.....	7-7
NEC 2 of 5.....	7-8
Code 93.....	7-9
Code 93 Code Page.....	7-10
Straight 2 of 5 Industrial (three-bar start/stop).....	7-11
Straight 2 of 5 IATA (two-bar start/stop).....	7-12
Matrix 2 of 5.....	7-13
Code 11.....	7-14
Code 128.....	7-15
ISBT 128 Concatenation.....	7-15
Code 128 Code Page.....	7-16

GS1-128 .....	7-17
UPC-A .....	7-17
UPC-A/EAN-13 with Extended Coupon Code .....	7-19
Coupon GS1 DataBar Output .....	7-20
UPC-E0 .....	7-20
UPC-E1 .....	7-22
EAN/JAN-13 .....	7-23
Convert UPC-A to EAN-13 .....	7-23
ISBN Translate .....	7-25
EAN/JAN-8 .....	7-25
MSI .....	7-27
GS1 DataBar Omnidirectional .....	7-29
GS1 DataBar Limited.....	7-29
GS1 DataBar Expanded .....	7-30
Codablock A .....	7-30
Codablock F .....	7-31
PDF417 .....	7-32
MacroPDF417 .....	7-32
MicroPDF417.....	7-33
GS1 Composite Codes.....	7-33
UPC/EAN Version.....	7-34
GS1 Emulation .....	7-34
TCIF Linked Code 39 (TLC39) .....	7-35
QR Code.....	7-35
QR Code Page .....	7-36
Data Matrix .....	7-37
Data Matrix Code Page .....	7-37
MaxiCode .....	7-38
Aztec Code .....	7-39
Aztec Code Page.....	7-39
Chinese Sensible (Han Xin) Code .....	7-40
Postal Codes - 2D .....	7-41
Single 2D Postal Codes:.....	7-41
Combination 2D Postal Codes:.....	7-42
Postal Codes - Linear .....	7-45
China Post (Hong Kong 2 of 5).....	7-45
Korea Post.....	7-46

## **Chapter 8 - Utilities**

To Add a Test Code I.D. Prefix to All Symbologies .....	8-1
Show Decoder Revision .....	8-1
Show Scan Driver Revision .....	8-1
Show Software Revision.....	8-1
Show Data Format.....	8-1
Test Menu.....	8-2
EZConfig-Scanning Introduction.....	8-2
Installing EZConfig-Scanning from the Web.....	8-2
Resetting the Factory Defaults .....	8-3



---

## **Chapter 9 - Serial Programming Commands**

Conventions.....	9-1
Menu Command Syntax .....	9-1
Query Commands .....	9-1
Responses.....	9-2
Trigger Commands.....	9-3
Resetting the Custom Defaults.....	9-3
Menu Commands .....	9-3

## **Chapter 10 - Product Specifications**

Voyager 1450g Scanner Product Specifications .....	10-1
Voyager 1450g2DHR Scanner Product Specifications .....	10-2
Voyager 1452g Cordless Scanner Product Specifications .....	10-3
CCB01-010BT Charge Base Product Specifications.....	10-4
Standard Cable Pinouts.....	10-5
Serial Output.....	10-5
USB .....	10-5
RS485 Output.....	10-6

## **Chapter 11 - Maintenance and Troubleshooting**

Repairs .....	11-1
Maintenance .....	11-1
Cleaning the Device.....	11-1
Inspecting Cords and Connectors .....	11-1
Replacing Cables in Corded Scanners.....	11-1
Replacing a Corded Scanner Interface Cable .....	11-2
Replacing Cables and Batteries in Cordless Systems .....	11-2
Replacing an Interface Cable in a Base .....	11-2
Changing a Cordless Scanner Battery .....	11-3
Troubleshooting a Corded Scanner.....	11-3
Troubleshooting a Cordless System.....	11-3
Troubleshooting a Base.....	11-3
Troubleshooting a Cordless Scanner .....	11-4

## **Appendix A - Reference Charts**

Symbology Charts .....	A-1
Linear Symbologies .....	A-1
2D Symbologies.....	A-2
Postal Symbologies .....	A-2
ASCII Conversion Chart (Code Page 1252).....	A-3
Lower ASCII Reference Table.....	A-4
ISO 2022/ISO 646 Character Replacements .....	A-7
Unicode Key Maps .....	A-9

## **Sample Symbols**

---

***Programming Chart***

---

## **Customer Support**

### ***Technical Assistance***

To search our knowledge base for a solution or to log in to the Technical Support portal and report a problem, go to [www.hsmcontactsupport.com](http://www.hsmcontactsupport.com).

For our latest contact information, see [www.honeywellaidc.com/locations](http://www.honeywellaidc.com/locations).

### ***Product Service and Repair***

Honeywell International Inc. provides service for all of its products through service centers throughout the world. To obtain warranty or non-warranty service, please visit [www.honeywellaidc.com](http://www.honeywellaidc.com) and select **Support > Contact Service and Repair** to see your region's instructions on how to obtain a Return Material Authorization number (RMA #). You should do this prior to returning the product.

### ***Limited Warranty***

Refer to [www.honeywellaidc.com/warranty\\_information](http://www.honeywellaidc.com/warranty_information) for your product's warranty information.

### ***Send Feedback***

Your feedback is crucial to the continual improvement of our documentation. To provide feedback about this manual, contact the Honeywell Technical Communications department at [ACSHSMTechnicalCommunications@honeywell.com](mailto:ACSHSMTechnicalCommunications@honeywell.com).



# Getting Started

## About This Manual

This User's Guide provides installation and programming instructions for the Voyager™ 1450g corded area-imaging scanners and Voyager 1452g cordless area-imaging scanners. Product specifications, dimensions, warranty, and customer support information are also included.

*Note: The selections in this User's Guide are dependent on the Voyager 145Xg model you have purchased. PDF and 2 dimensional bar codes can only be read by model 145Xg2D and cannot be read by model 145Xg1D.*

Honeywell bar code scanners are factory programmed for the most common terminal and communications settings. If you need to change these settings, programming is accomplished by scanning the bar codes in this guide.

An asterisk (\*) next to an option indicates the default setting.

## Unpacking Your Device

After you open the shipping carton containing the product, take the following steps:

- Check for damage during shipment. Report damage immediately to the carrier who delivered the carton.
- Make sure the items in the carton match your order.
- Save the shipping container for later storage or shipping.

## Connecting the Device

### Connecting with USB

A scanner or a cordless base can be connected to the USB port of a computer.

1. Connect the appropriate interface cable to the device first, then to the computer.

**Corded Voyager 1450g  
USB Connection:**

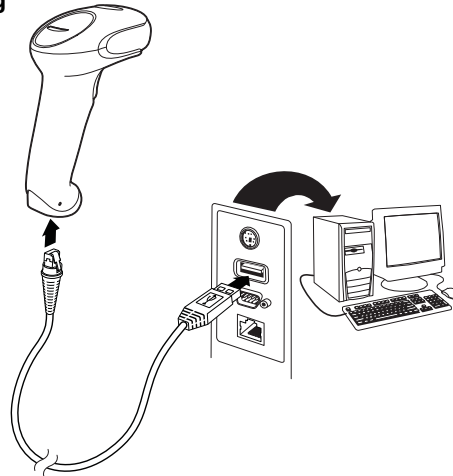

---

**CCB01-010BT Base  
USB Connection:**

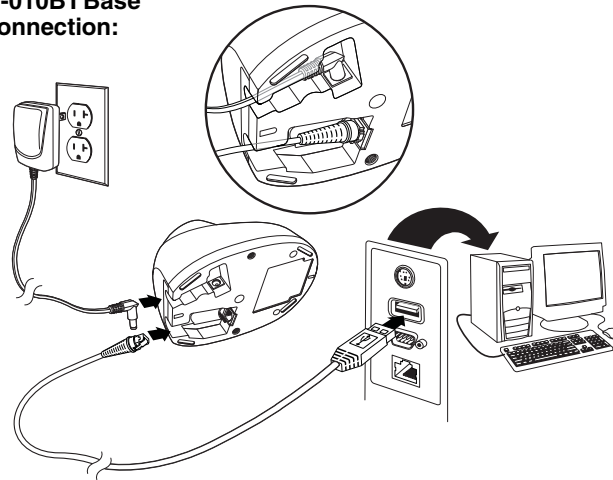

*Note: The power supply must be ordered separately, if needed.*

2. If you are connecting a CCB01-010BT Base, make sure the cables are secured in the wireways in the bottom of the cordless base and the base sits flat on a horizontal surface.
3. The scanner beeps.
4. Verify the scanner or cordless base operation by scanning a bar code from the [Sample Symbols](#) in the back of this manual.

The unit defaults to a USB PC Keyboard. Refer to [page 2-3](#) for other USB terminal settings.

For additional USB programming and technical information, refer to "USB Application Note," available at [www.honeywellaidc.com](http://www.honeywellaidc.com).

---

## Connecting with Keyboard Wedge

A scanner or cordless base can be connected between the keyboard and PC as a “keyboard wedge,” where the scanner provides data output that is similar to keyboard entries. The following is an example of a keyboard wedge connection:

1. Turn off power and disconnect the keyboard cable from the back of the terminal/computer.
2. Connect the appropriate interface cable to the device and to the terminal/computer.

### Corded Voyager 1450g Keyboard Wedge Connection:

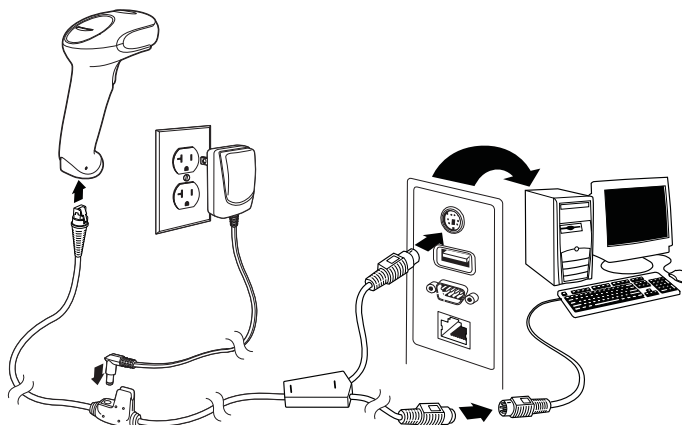

### CCB01-010BT Base Keyboard Wedge Connection:

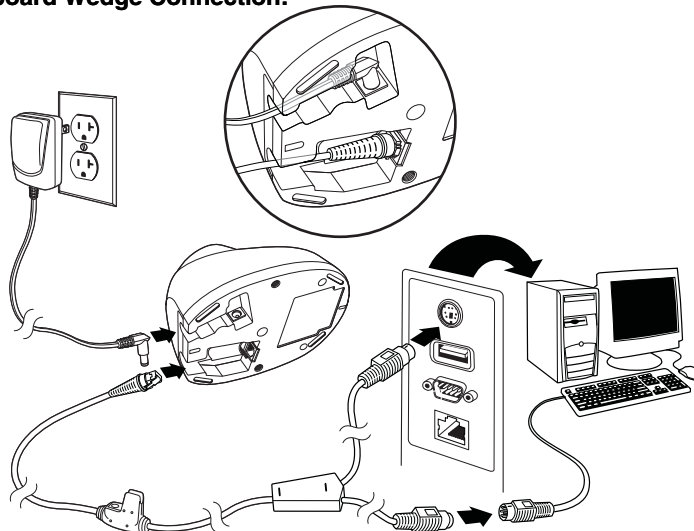

*Note: The power supply must be ordered separately, if needed.*

3. If you are connecting a CCB01-010BT Base, make sure the cables are secured in the wireways in the bottom of the cordless base and the base sits flat on a horizontal surface.
4. Turn the terminal/computer power back on. The scanner beeps.
5. Verify the scanner or cordless base operation by scanning a bar code from the [Sample Symbols](#) in the back of this manual. The scanner beeps once.

The unit defaults to an IBM PC AT and compatibles keyboard wedge interface with a USA keyboard. A carriage return (CR) suffix is added to bar code data.

---

## Connecting with RS232 Serial Port

1. Turn off power to the terminal/computer.
2. Connect the appropriate interface cable to the device.

*Note: For the scanner or cordless base to work properly, you must have the correct cable for your type of terminal/computer.*

### Corded Voyager 1450g RS232 Serial Port Connection:

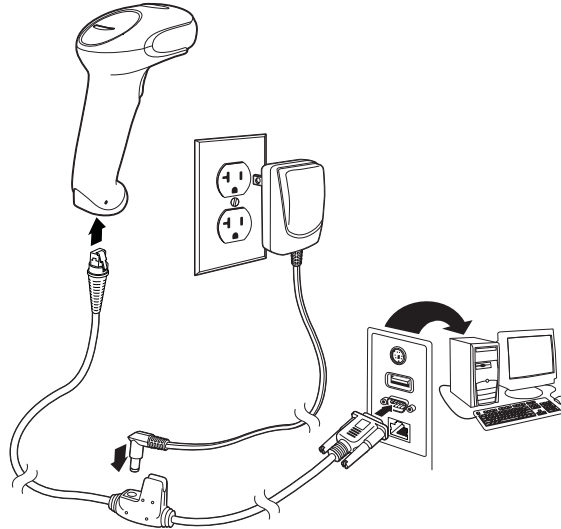

### CCB01-010BT Base RS232 Serial Port Connection:

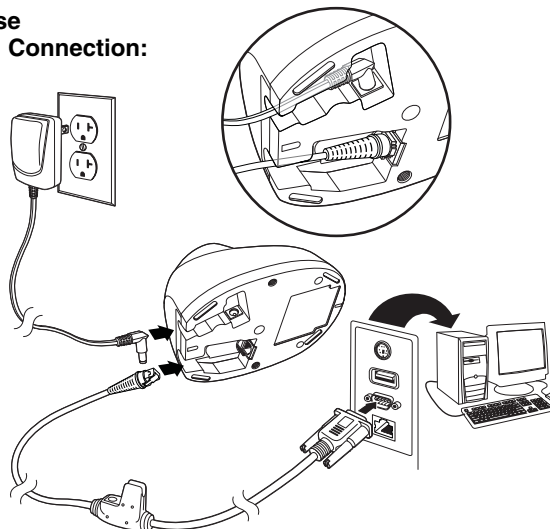

*Note: The power supply must be ordered separately, if needed.*

3. If you are connecting a CCB01-010BT Base, make sure the cables are secured in the wireways in the bottom of the cordless base and the base sits flat on a horizontal surface.
4. Plug the serial connector into the serial port on your computer. Tighten the two screws to secure the connector to the port.
5. Once the scanner or cordless base has been fully connected, power up the computer.

This interface programs 115,200 baud, 8 data bits, no parity, and 1 stop bit.



---

## Connecting with RS485

A scanner or cordless base can be connected for an IBM POS terminal interface.

1. Connect the appropriate interface cable to the device, then to the computer.

### Corded Voyager 1450g RS232 Serial Port Connection:

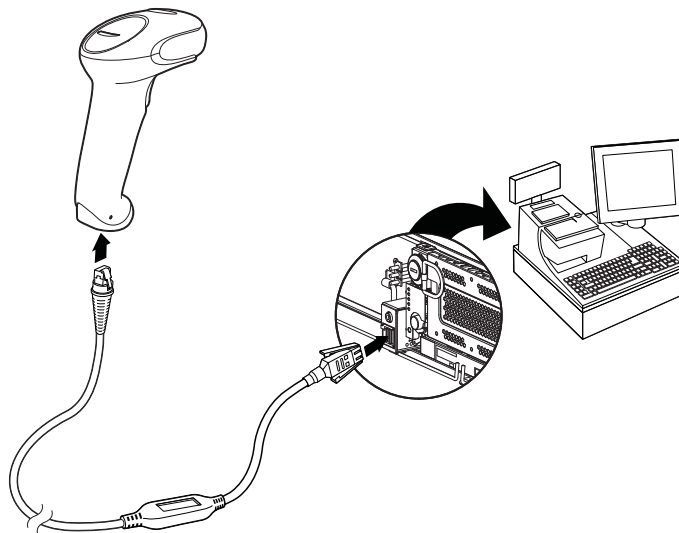

### CCB01-010BT Base RS485 Connection:

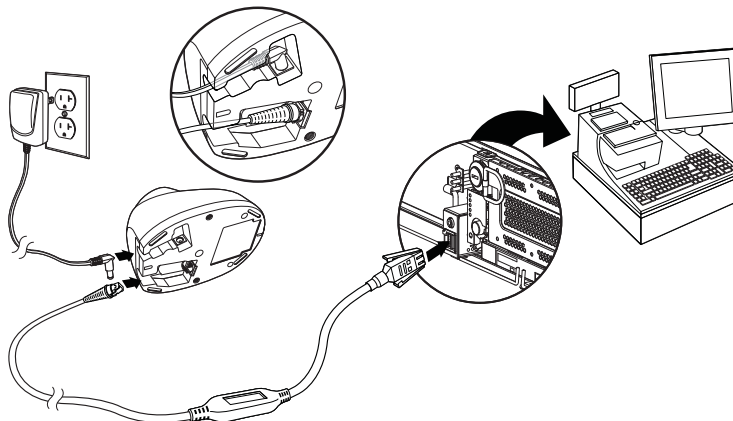

2. Turn the terminal/computer power back on. The scanner beeps.
3. Verify the scanner or cordless base operation by scanning a bar code from the [Sample Symbols](#) in the back of this manual. The scanner beeps once.

For further RS485 settings, refer to [RS485](#), page 2-2.

---

## Mounting a CCB01-010BT Charge Base

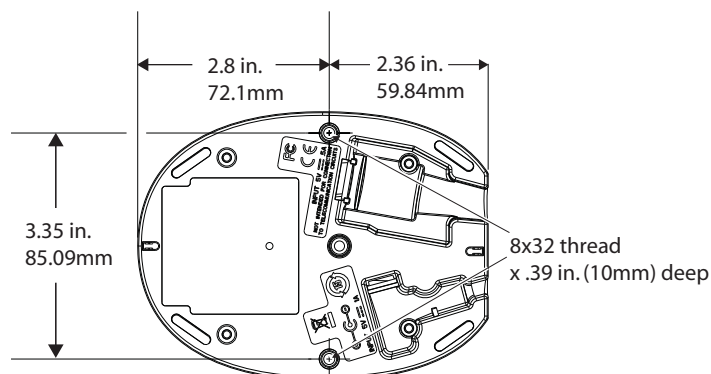

## Reading Techniques

The scanner has a view finder that projects a bright red aiming beam that corresponds to the scanner's horizontal field of view. The aiming beam should be centered over the bar code, but it can be positioned in any direction for a good read.

Linear bar code

2D Matrix symbol

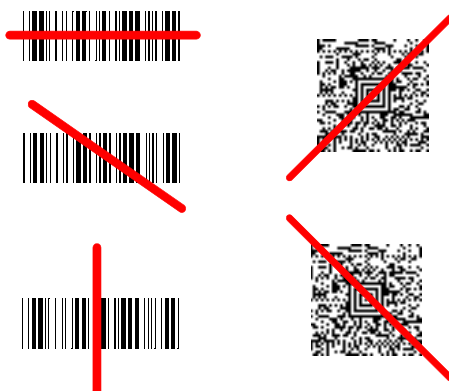

The aiming beam is smaller when the scanner is closer to the code and larger when it is farther from the code. Symbologies with smaller bars or elements (mil size) should be read closer to the unit. Symbologies with larger bars or elements (mil size) should be read farther from the unit. To read single or multiple symbols (on a page or on an object), hold the scanner at an appropriate distance from the target, press the trigger, and center the aiming beam on the symbol. If the code being scanned is highly reflective (e.g., laminated), it may be necessary to tilt the code up 15° to 18° to prevent unwanted reflection.

## Menu Bar Code Security Settings

Honeywell scanners are programmed by scanning menu bar codes or by sending serial commands to the scanner. If you want to restrict the ability to scan menu codes, you can use the Menu Bar Code Security settings. Please contact the nearest technical support office (see [Customer Support](#) on page ix) for further information.

---

## Setting Custom Defaults

You have the ability to create a set of menu commands as your own, custom defaults. To do so, scan the **Set Custom Defaults** bar code below before scanning the menu commands for your custom defaults. If a menu command requires scanning numeric codes from the back cover, then a **Save** code, that entire sequence will be saved to your custom defaults. When you have entered all the commands you want to save for your custom defaults, scan the **Save Custom Defaults** bar code.



MNUCDP.  
**Set Custom Defaults**



MNUCDS.  
**Save Custom Defaults**

*Note: When using a cordless system, the Custom Defaults settings apply to all workgroups. Scanning the **Save Defaults** bar code also causes both the scanner and the base or Access Point to perform a reset and become unlinked. The scanner must be placed in its base to re-establish the link before any setup codes are entered. If using an Access Point, the linking bar code must be scanned. See [Cordless System Operation](#) beginning on page 3-1 for additional information.*

You may have a series of custom settings and want to correct a single setting. To do so, just scan the new setting to overwrite the old one. For example, if you had previously saved the setting for Beeper Volume at Low to your custom defaults, and decide you want the beeper volume set to High, just scan the **Set Custom Defaults** bar code, then scan the Beeper Volume High menu code, and then **Save Custom Defaults**. The rest of the custom defaults will remain, but the beeper volume setting will be updated.

## Resetting the Custom Defaults

If you want the custom default settings restored to your scanner, scan the **Activate Custom Defaults** bar code below. This is the recommended default bar code for most users. It resets the scanner to the custom default settings. If there are no custom defaults, it will reset the scanner to the factory default settings. Any settings that have not been specified through the custom defaults will be defaulted to the factory default settings.



DEFAULT.  
**Activate Custom Defaults**

*Note: If using a cordless system, scanning this bar code also causes both the scanner and the base or Access Point to perform a reset and become unlinked. The scanner must be placed in its base to re-establish the link. If using an Access Point, the linking bar code must be scanned. See [Cordless System Operation](#) beginning on page 3-1 for additional information.*



# Programming the Interface

## Introduction

This chapter describes how to program your system for the desired interface.

## Programming the Interface - Plug and Play

Plug and Play bar codes provide instant scanner set up for commonly used interfaces.

*Note: After you scan one of the codes, power cycle the host terminal to have the interface in effect.*

## Keyboard Wedge

If you want your system programmed for an IBM PC AT and compatibles keyboard wedge interface with a USA keyboard, scan the bar code below. Keyboard wedge is the default interface.

*Note: The following bar code also programs a carriage return (CR) suffix.*



## Laptop Direct Connect

For most laptops, scanning the **Laptop Direct Connect** bar code allows operation of the scanner in parallel with the integral keyboard. The following **Laptop Direct Connect** bar code also programs a carriage return (CR) suffix and turns on Emulate External Keyboard ([page 2-16](#)).



## RS232 Serial Port

The **RS232 Interface** bar code is used when connecting to the serial port of a PC or terminal. The following **RS232 Interface** bar code also programs a carriage return (CR) and a line feed (LF) suffix, baud rate, and data format as indicated below. It also changes the trigger mode to manual.

Option	Setting
Baud Rate	115,200 bps
Data Format	8 data bits, no parity bit, 1 stop bit



---

## RS485

Scan one of the following “Plug and Play” codes to program the scanner for an IBM POS terminal interface.

*Note: After scanning one of these codes, you must power cycle the cash register.*



PAPP5B.

**IBM Port 5B Interface**



PAP9B1.

**IBM Port 9B  
HHBCR-1 Interface**



PAPP17.

**IBM Port 17 Interface**



PAP9B2.

**IBM Port 9B  
HHBCR-2 Interface**

Each bar code above also programs the following suffixes for each symbology:

Symbology	Suffix	Symbology	Suffix
EAN 8	0C	Code 39	00 0A 0B
EAN 13	16	Interleaved 2 of 5	00 0D 0B
UPC A	0D	Code 128 *	00 0A 0B
UPC E	0A	Code 128 **	00 18 0B
		MaxiCode	00 2F 0B

\* Suffixes programmed for Code 128 with IBM 4683 Port 5B, IBM 4683 Port 9B HHBCR-1, and IBM 4683 Port 17 Interfaces

\*\* Suffixes programmed for Code 128 with IBM 4683 Port 9 HHBCR-2 Interface

### RS485 Packet Mode

The following selection allows you to break up large bar code data into smaller packets on an IBM POS terminal. To break up large bar codes into small packets, scan the Packet Mode On bar code below. Scan the Packet Mode Off bar code if you want large bar code data to be sent to the host in a single chunk. *Default = Packet Mode Off.*



RTLPDF0.

**\* Packet Mode Off**



RTLPDF1.

**Packet Mode On**

---

## RS485 Packet Length

If you are using Packet mode, you can specify the size of the data “packet” that is sent to the host. Scan the **Packet Length** bar code, then then the packet size (from 20 - 256) from the [Programming Chart](#) inside the back cover of this manual, then **Save**. *Default = 40.*



## USB IBM SurePos

Scan one of the following “Plug and Play” codes to program the scanner for an IBM SurePos (USB handheld scanner) or IBM SurePos (USB tabletop scanner) interface.

*Note: After scanning one of these codes, you must power cycle the cash register.*



Each bar code above also programs the following suffixes for each symbology:

Symbology	Suffix	Symbology	Suffix
EAN 8	0C	Code 39	00 0A 0B
EAN 13	16	Interleaved 2 of 5	00 0D 0B
UPC A	0D	Code 128	00 18 0B
UPC E	0A	Code 39	00 0A 0B

## USB PC or Macintosh Keyboard

Scan one of the following codes to program the scanner for USB PC Keyboard or USB Macintosh Keyboard. Scanning these codes also adds a CR and LF.



---

## **USB HID**

Scan the following code to program the scanner for USB HID bar code scanners.



PAP131.  
**USB HID Bar Code Scanner**

## **USB Serial**

Scan the following code to program the scanner to emulate a regular RS232-based COM Port. If you are using a Microsoft® Windows® PC, you will need to download a driver from the Honeywell website ([www.honeywellaidc.com](http://www.honeywellaidc.com)). The driver will use the next available COM Port number. Apple® Macintosh computers recognize the scanner as a USB CDC class device and automatically uses a class driver.



TRMUSB130.  
**USB Serial**

*Note: No extra configuration (e.g., baud rate) is necessary.*

### **CTS/RTS Emulation**



USBCTS1.  
**CTS/RTS Emulation On**



USBCTS0.  
**\* CTS/RTS Emulation Off**

### **ACK/NAK Mode**



USBACK1.  
**ACK/NAK Mode On**



USBACK0.  
**\* ACK/NAK Mode Off**



---

## Remote MasterMind™ for USB

When using a USB interface, you may wish to configure your scanner to communicate with Remote MasterMind Scanner Management Software (ReM). Scan the **ReM On** bar code to communicate with ReM. To disable this capability, scan **ReM Off**. Default = ReM On.

Note: Remote MasterMind settings apply only to the Voyager 1450g. They are not supported by the Voyager 1452g.



## Verifone® Ruby Terminal Default Settings

Scan the following Plug and Play code to program the scanner for a Verifone Ruby terminal. This bar code sets the baud rate to 1200 bps and the data format to 8 data bits, mark parity bit, 1 stop bit. It also adds a line feed (LF) suffix and programs the following prefixes for each symbology:

Symbology	Prefix
UPC-A	A
UPC-E	A
EAN-8	FF
EAN-13	F



## Gilbarco® Terminal Default Settings

Scan the following Plug and Play code to program the scanner for a Gilbarco terminal. This bar code sets the baud rate to 2400 bps and the data format to 7 data bits, even parity, 2 stop bits. It also adds a carriage return (CR) suffix and programs the following prefixes for each symbology:

Symbology	Prefix
UPC-A	A
UPC-E	E0
EAN-8	FF
EAN-13	F



---

## **Honeywell Bioptic Aux Port Configuration**

Scan the following Plug and Play code to program the scanner for a Honeywell bioptic scanner auxiliary port configuration. This bar code sets the baud rate to 38400 bps and the data format to 8 data bits, no parity, 1 stop bit.



PAPBIO.  
Honeywell Bioptic Settings

## **Datalogic™ Magellan® Bioptic Aux Port Configuration**

Scan the following Plug and Play code to program the scanner for a Datalogic Magellan bioptic scanner auxiliary port configuration. This bar code sets the baud rate to 9600 bps and the data format to 8 data bits, no parity, 1 stop bit.



PAPMAG.  
Datalogic Magellan Bioptic Settings

## **NCR Bioptic Aux Port Configuration**

Scan the following Plug and Play code to program the scanner for an NCR bioptic scanner auxiliary port configuration. The following prefixes are programmed for each symbology:

Symbology	Prefix	Symbology	Prefix
UPC-A	A	Interleaved 2 of 5	b
UPC-E	E0	Code 128	f
		GS1 DataBar Omnidirectional	r
EAN-8	FF	GS1 DataBar Expanded	r
EAN-13	F	Codabar	N
Code 39	a	Code 32 Pharmaceutical (PARAF)	a



PAPNCR.  
NCR Bioptic Settings

## **Wincor Nixdorf Terminal Default Settings**

Scan the following Plug and Play code to program the scanner for a Wincor Nixdorf terminal. This bar code sets the baud rate to 9600 bps and the data format to 8 data bits, no parity, 1 stop bit.



PAPWNX.  
Wincor Nixdorf Terminal Settings

---

## **Wincor Nixdorf Beetle™ Terminal Default Settings**

Scan the following Plug and Play code to program the scanner for a Wincor Nixdorf Beetle terminal. This bar code sets the baud rate to 115200 bps and the data format to 8 data bits, no parity, 1 stop bit. The following prefixes are programmed for each symbology:

<b>Symbology</b>	<b>Prefix</b>	<b>Symbology</b>	<b>Prefix</b>
Aztec Code	V	Interleaved 2 of 5	I
Codabar	N	MaxiCode	T
Code 93	L	MicroPDF417	S
Code 128	K	PDF417	Q
Data Matrix	R	QR Code	U
EAN-8	B	Straight 2 of 5 IATA	H
EAN-13	A	UPC-A	A0
GS1 DataBar	E	UPC-E	C
GS1-128	P	All other bar codes	M



PAPBTL.

**Wincor Nixdorf Beetle Settings**

## **Wincor Nixdorf RS232 Mode A**

Scan the following Plug and Play code to program the scanner for a Wincor Nixdorf RS232 Mode A terminal. This bar code sets the baud rate to 9600 bps and the data format to 8 data bits, odd parity, 1 stop bit. The following prefixes are programmed for each symbology:

<b>Symbology</b>	<b>Prefix</b>	<b>Symbology</b>	<b>Prefix</b>
Code 128	K	EAN-13	A
Code 93	L	GS1-128	K
Codabar	N	Interleaved 2 of 5	I
UPC-A	A0	Plessey	O
UPC-E	C	Straight 2 of 5 IATA	H
EAN-8	B	GS1 DataBar	E
All other bar codes	M		



PAPWMA.

**Wincor Nixdorf RS232 Mode A Settings**

---

## Keyboard Country Layout

If your interface is USB Keyboard or Keyboard Wedge, your keyboard layout default is a US keyboard. To change this layout, refer to the chart below for your keyboard country. Scan the appropriate bar code below to change the layout.

By default, national character replacements are used for the following characters: # \$ @ [ \ ] ^ ' { | } ~ See [ISO 2022/ISO 646 Character Replacements](#) on page A-7 to view the character replacements for each country.

### Keyboard Countries



KBDCTY0.  
\* United States



KBDCTY35.  
Albania



KBDCTY81.  
Azeri (Cyrillic)



KBDCTY80.  
Azeri (Latin)



KBDCTY82.  
Belarus



KBDCTY1.  
Belgium



KBDCTY33.  
Bosnia



KBDCTY16.  
Brazil



KBDCTY59.  
Brazil (MS)



KBDCTY52.  
Bulgaria (Cyrillic)

---

## **Keyboard Countries (Continued)**



KBDCTY53.  
**Bulgaria (Latin)**



KBDCTY18.  
**Canada (French)**



KBDCTY32.  
**Croatia**



KBDCTY40.  
**Czech (Programmers)**



KBDCTY38.  
**Czech (QWERTZ)**



KBDCTY11.  
**Dutch (Netherlands)**



KBDCTY54.  
**Canada (French legacy)**



KBDCTY55.  
**Canada (Multilingual)**



KBDCTY15.  
**Czech**



KBDCTY39.  
**Czech (QWERTY)**



KBDCTY8.  
**Denmark**

---

## Keyboard Countries (Continued)



KBDCTY83.  
Faroese



KBDCTY3.  
France



KBDCTY4.  
Germany



KBDCTY64.  
Greek (220 Latin)



KBDCTY65.  
Greek (319 Latin)



KBDCTY41.  
Estonia



KBDCTY2.  
Finland



KBDCTY84.  
Gaelic



KBDCTY17.  
Greek



KBDCTY61.  
Greek (220)



KBDCTY62.  
Greek (319)

---

## Keyboard Countries (Continued)



KBDCTY63.  
Greek (Latin)



KBDCTY60.  
Greek (Polytonic)



KBDCTY50.  
Hungarian (101 key)



KBDCTY75.  
Iceland



KBDCTY56.  
Italian (142)



KBDCTY28.  
Japan ASCII



KBDCTY66.  
Greek (MS)



KBDCTY12.  
Hebrew



KBDCTY19.  
Hungary



KBDCTY73.  
Irish



KBDCTY5.  
Italy

---

## Keyboard Countries (Continued)



KBDCTY79.  
Kyrgyz (Cyrillic)



KBDCTY42.  
Latvia



KBDCTY44.  
Lithuania



KBDCTY34.  
Macedonia



KBDCTY86.  
Mongolian (Cyrillic)



KBDCTY78.  
Kazakh



KBDCTY14.  
Latin America



KBDCTY43.  
Latvia (QWERTY)



KBDCTY45.  
Lithuania (IBM)



KBDCTY74.  
Malta



KBDCTY9.  
Norway



---

## Keyboard Countries (Continued)



KBDCTY20.  
Poland



KBDCTY58.  
Polish (Programmers)



KBDCTY25.  
Romania



KBDCTY67.  
Russian (MS)



KBDCTY21.  
SCS



KBDCTY36.  
Serbia (Latin)



KBDCTY57.  
Polish (214)



KBDCTY13.  
Portugal



KBDCTY26.  
Russia



KBDCTY68.  
Russian (Typewriter)



KBDCTY37.  
Serbia (Cyrillic)

---

## Keyboard Countries (Continued)



KBDCTY49.  
Slovakia (QWERTY)



KBDCTY31.  
Slovenia



KBDCTY51.  
Spanish variation



KBDCTY29.  
Switzerland (French)



KBDCTY85.  
Tatar



KBDCTY22.  
Slovakia



KBDCTY48.  
Slovakia (QWERTZ)



KBDCTY10.  
Spain



KBDCTY23.  
Sweden



KBDCTY6.  
Switzerland (German)



KBDCTY27.  
Turkey F

---

## Keyboard Countries (Continued)



KBDCTY24.  
Turkey Q



KBDCTY76.  
Ukrainian



KBDCTY7.  
United Kingdom



KBDCTY87.  
United States (Dvorak)



KBDCTY88.  
United States (Dvorak left)



KBDCTY89.  
United States (Dvorak right)



KBDCTY30.  
United States (International)



KBDCTY77.  
Uzbek (Cyrillic)

## Keyboard Style

This program's keyboard styles, such as Caps Lock and Shift Lock. If you have used [Keyboard Conversion](#) settings, they will override any of the following Keyboard Style settings. *Default = Regular.*

**Regular** is used when you normally have the Caps Lock key off.



KBDSTY0.  
\* Regular

**Caps Lock** is used when you normally have the Caps Lock key on.



KBDSTY1.  
Caps Lock

---

**Shift Lock** is used when you normally have the Shift Lock key on (not common to U.S. keyboards).



KBDSTY2.  
**Shift Lock**

**Automatic Caps Lock** is used if you change the Caps Lock key on and off. The software tracks and reflects if you have Caps Lock on or off. This selection can only be used with systems that have an LED that notes the Caps Lock status (AT keyboards).



KBDSTY6.  
**Automatic Caps Lock**

**Autocaps via NumLock** bar code should be scanned in countries (e.g., Germany, France) where the Caps Lock key cannot be used to toggle Caps Lock. The NumLock option works similarly to the regular Autocaps, but uses the NumLock key to retrieve the current state of the Caps Lock.



KBDSTY7.  
**Autocaps via NumLock**

**Emulate External Keyboard** should be scanned if you do not have an external keyboard (IBM AT or equivalent).



KBDSTY5.  
**Emulate External Keyboard**

*Note: After scanning the Emulate External Keyboard bar code, you must power cycle your computer.*

## **Keyboard Conversion**

Alphabetic keyboard characters can be forced to be all upper case or all lowercase. So if you have the following bar code: "abc569GK," you can make the output "ABC569GK" by scanning **Convert All Characters to Upper Case**, or to "abc569gk" by scanning **Convert All Characters to Lower Case**.

These settings override [Keyboard Style](#) selections.

*Note: If your interface is a keyboard wedge, first scan the menu code for [Automatic Caps Lock](#) (page 2-16). Otherwise, your output may not be as expected.*

Default = Keyboard Conversion Off.



KBDCNV0.

**\* Keyboard Conversion Off**



KBDCNV1.

**Convert All Characters  
to Upper Case**



KBDCNV2.

**Convert All Characters  
to Lower Case**

---

## Control Character Output

This selection sends a text string instead of a control character. For example, when the control character for a carriage return is expected, the output would display [CR] instead of the ASCII code of 0D. Refer to [ASCII Conversion Chart \(Code Page 1252\)](#) on page A-3. Only codes 00 through 1F are converted (the first column of the chart). *Default = Off.*

*Note: Control + ASCII Mode overrides this mode.*



KBDNPE1.

**Control Character Output On**



KBDNPE0.

**\* Control Character Output Off**

## Keyboard Modifiers

This modifies special keyboard features, such as CTRL+ ASCII codes and Turbo Mode.

**Control + ASCII Mode On:** The scanner sends key combinations for ASCII control characters for values 00-1F. Windows is the preferred mode. All keyboard country codes are supported. DOS mode is a legacy mode, and it does not support all keyboard country codes. New users should use the Windows mode. Refer to [ASCII Conversion Chart \(Code Page 1252\)](#), page A-3 for CTRL+ ASCII Values.

**Windows Mode Prefix/Suffix Off:** The scanner sends key combinations for ASCII control characters for values 00-1F, but it does not translate any prefix or suffix information.

*Default = Control + ASCII Mode Off.*



KBDCAS2.

**Windows Mode Control + X  
Mode On**



KBDCAS0.

**\* Control + X Mode Off**



KBDCAS1.

**DOS Mode Control + X Mode On**



KBDCAS3.

**Windows Mode Prefix/Suffix Off**

---

**Turbo Mode:** The scanner sends characters to a terminal faster. If the terminal drops characters, do not use Turbo Mode.  
*Default = Off.*



**Numeric Keypad Mode:** Sends numeric characters as if entered from a numeric keypad. *Default = Off.*



**Automatic Direct Connect Mode:** This selection can be used if you have an IBM AT style terminal and the system is dropping characters. *Default = Off.*



## **RS232 Modifiers**

### **RS232 Baud Rate**

Baud Rate sends the data from the scanner to the terminal at the specified rate. The host terminal must be set for the same baud rate as the scanner. *Default = 115200.*





232BAD2.  
1200



232BAD3.  
2400



232BAD4.  
4800



232BAD5.  
9600



232BAD6.  
19200



232BAD7.  
38400



232BAD8.  
57,600



232BAD9.  
\* 115,200

### ***RS232 Word Length: Data Bits, Stop Bits, and Parity***

**Data Bits** sets the word length at 7 or 8 bits of data per character. If an application requires only ASCII Hex characters 0 through 7F decimal (text, digits, and punctuation), select 7 data bits. For applications that require use of the full ASCII set, select 8 data bits per character. *Default = 8.*

**Stop Bits** sets the stop bits at 1 or 2. *Default = 1.*

**Parity** provides a means of checking character bit patterns for validity.

*Default = None.*



232WRD3.  
7 Data, 1 Stop, Parity Even



232WRD6.  
7 Data, 1 Stop, Parity Odd



232WRD1.  
7 Data, 2 Stop Parity None



232WRD5.  
8 Data, 1 Stop, Parity Even



232WRD8.  
8 Data, 1 Stop, Parity Odd



232WRD0.  
7 Data, 1 Stop, Parity None



232WRD4.  
7 Data, 2 Stop, Parity Even



232WRD7.  
7 Data, 2 Stop, Parity Odd



232WRD2.  
\* 8 Data, 1 Stop, Parity None

### ***RS232 Receiver Time-Out***

The unit stays awake to receive data until the RS232 Receiver Time-Out expires. A manual trigger resets the time-out. When an RS232 receiver is sleeping, a character may be sent to wake up the receiver and reset the time-out. A transaction on the CTS line will also wake up the receiver. The receiver takes 300 milliseconds to completely come up. Change the RS232 receiver time-out by scanning the bar code below, then scanning digits from the inside back cover of this manual, then scanning **Save**. The range is 0 to 300 seconds. *Default = 0 seconds (no time-out - always on).*



232LPT.  
RS232 Receiver Time-Out

### ***RS232 Handshaking***

RS232 Handshaking allows control of data transmission from the scanner using software commands from the host device. When RTS/CTS is turned **Off**, no data flow control is used.

**Flow Control, No Timeout:** The scanner asserts RTS when it has data to send, and will wait indefinitely for CTS to be asserted by the host.



---

**Two-Direction Flow Control:** The scanner asserts RTS when it is OK for the host to transmit. The host asserts CTS when it is OK for the device to transmit.

**Flow Control with Timeout:** The scanner asserts RTS when it has data to send and waits for a delay (see [RS232 Timeout](#) on page 2-21) for CTS to be asserted by the host. If the delay time expires and CTS is not asserted, the device transmit buffer is cleared and scanning may resume. *Default = RTS/CTS Off.*



232CTS1.

**Flow Control, No Timeout**



232CTS2.

**Two-Direction Flow Control**



232CTS3.

**Flow Control with Timeout**



232CTS0.

**\* RTS/CTS Off**

## **RS232 Timeout**

When using Flow Control with Timeout, you must program the length of the delay you want to wait for CTS from the host. Set the length (in milliseconds) for a timeout by scanning the bar code below, then setting the timeout (from 1-5100 milliseconds) by scanning digits from the inside back cover, then scanning **Save**.



232DEL.

**RS232 Timeout**

## **XON/XOFF**

Standard ASCII control characters can be used to tell the scanner to start sending data (**XON/XOFF On**) or to stop sending data (**XON/XOFF Off**). When the host sends the XOFF character (DC3, hex 13) to the scanner, data transmission stops. To resume transmission, the host sends the XON character (DC1, hex 11). Data transmission continues where it left off when XOFF was sent. *Default = XON/XOFF Off.*



232XON1.

**XON/XOFF On**



232XON0.

**\* XON/XOFF Off**

---

## ACK/NAK

After transmitting data, the scanner waits for an ACK character (hex 06) or a NAK character (hex 15) response from the host. If ACK is received, the communications cycle is completed and the scanner looks for more bar codes. If NAK is received, the last set of bar code data is retransmitted and the scanner waits for ACK/NAK again. Turn on the ACK/NAK protocol by scanning the **ACK/NAK On** bar code below. To turn off the protocol, scan **ACK/NAK Off**. *Default = ACK/NAK Off.*



## Scanner to Bioptic Communication

The following settings are used to set up communication between Honeywell scanners and bioptic scanners.

*Note: The scanner's baud rate must be set to 38400 and the RS232 timeout must be set to 3000 in order to communicate with a bioptic scanner. See "RS232 Baud Rate" on page 2-18, and [RS232 Timeout](#) on page 2-21 for further information.*

### Scanner-Bioptic Packet Mode

**Packet Mode On** must be scanned to set the scanner's format so it is compatible with a bioptic scanner. *Default = Packet Mode Off.*



### Scanner-Bioptic ACK/NAK Mode

**Bioptic ACK/NAK On** must be scanned so the scanner will wait for an ACK or NAK from a bioptic scanner after each packet is sent. The Scanner-Bioptic ACK/NAK Timeout (below) controls how long the scanner will wait for a response. *Default = Bioptic ACK/NAK Off.*



---

### **Scanner-Bioptic ACK/NAK Timeout**

This allows you to set the length (in milliseconds) for a timeout for a bioptic scanner's ACK/NAK response. Scan the bar code below, then set the timeout (from 1-30,000 milliseconds) by scanning digits from the inside back cover, then scanning **Save**. *Default = 5100.*



232DLK

**ACK/NAK Timeout**



## Cordless System Operation

*Note: This chapter applies only to cordless scanning systems. It does not apply to corded scanners.*

### How the Cordless Charge Base/Access Point Works

A cordless charge base or an Access Point provide the link between the cordless scanner and the host system. The base/Access Point contains an interface assembly and an RF communication module. The RF communication module performs the data exchange between the cordless scanner and the interface assembly. The control assembly coordinates the central interface activities including: transmitting/receiving commands and data to/from the host system, performing software activities (parameter menuing, visual indicator support, power-on diagnostics), and data translation required for the host system.

The cordless charge base is also a scanner's battery charger. Refer to [Charging Information](#), page 3-4, for additional information.

### Linking the Scanner to a Charge Base

Turn off power before connecting a base, then power up the computer once the base is fully connected. When the base is connected and powered up, put the scanner in the base to establish a link. The green LED on the base flashes to indicate the scanner's battery is charging.

If the scanner and base have previously been linked, you do not receive any feedback. If this is the first time that the scanner and base are linked, both devices emit a short chirp when their radios link. At this point, that one scanner is linked to one base.

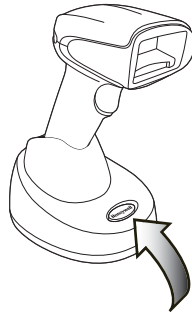

**CCB01-010BT Charge Base  
Page Button and Base LEDs**

To determine if your cordless system is set up correctly, scan one of the sample bar codes in the back of this manual. If the scanner provides a single good read beep and the green LED lights, the scanner has successfully linked to the base. If you receive an error tone and the red LED lights, the scanner has not linked to the base. Refer to [page 4](#) for troubleshooting information.

### Linking the Scanner to an Access Point

Turn on the computer (laptop/desktop). Plug the interface cable into the Access Point first and then into the appropriate port on the computer. The Page button lights up when the connection to the host is made.

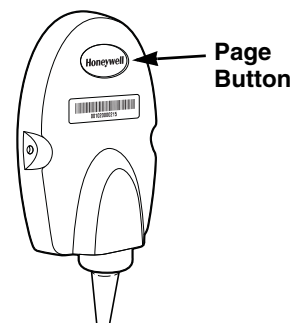

---

Scan the linking bar code on the top of the Access Point to establish a connection between the Access Point and the scanner. The scanner emits a short beep and flashes the green LED to confirm a connection with the Access Point. The Access Point's Page button remains blue.

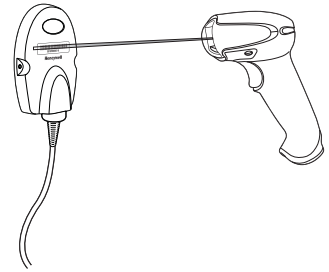

## ***Replacing a Linked Scanner***

If you need to replace a broken or lost scanner that is linked to a base or an Access Point, scan the **Override Locked Scanner** bar code below with a new scanner and place that scanner in the base, or scan the Access Point linking bar code. The locked link will be overridden; the broken or lost scanner's link with the base or Access Point will be removed, and the new scanner will be linked.



## ***Communication Between the Cordless System and the Host***

The cordless scanner provides immediate feedback in the form of a "good read" indication with a green LED on the scanner and an audible beep. This indicates that the bar code has been scanned correctly and the base or Access Point has acknowledged receiving the data. This is possible since the cordless system provides two-way communication between the scanner and the base or Access Point.

When data is scanned, the data is sent to the host system via the base or Access Point. The cordless scanner recognizes data acknowledgement (ACK) from the base or Access Point. If it cannot be determined that the data has been properly sent to the base or Access Point, the scanner issues an error indication. You must then check to see if the scanned data was received by the host system.

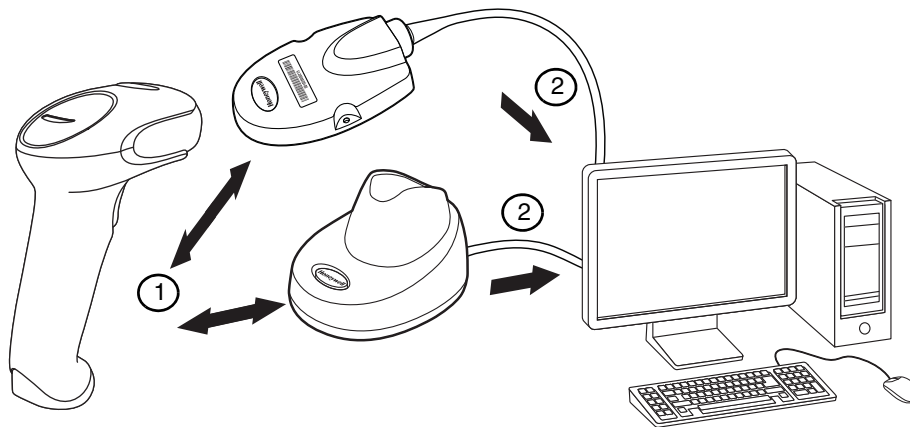

1. Scanner reads code and gets ACK from base or Access Point
2. Base or Access Point sends data to host

---

## **Programming the Scanner and Base or Access Point**

When using the scanner and charge base or Access Point together as a system, menu parameters and configuration settings are stored in the charge base or Access Point. Therefore, when programming any menu configuration settings, the scanner must be linked to the intended charge base or Access Point.

*Note: This only applies when the scanner is linked to a charge base or Access Point. If the scanner is in a non-base mode, configuration settings are stored in the scanner.*

## **RF (Radio Frequency) Module Operation**

The cordless system uses a two-way Bluetooth® radio utilizing adaptive frequency hopping (AFH) to transmit and receive data between the scanner and the base or Access Point. Designed for point-to-point and multipoint-to-single point applications, the radio operates using a license free ISM band, which sends relatively small data packets at a fast data rate over a radio signal with randomly changing frequencies, makes the cordless system highly responsive to a wide variety of data collection applications and resistant to noisy RF environments. The CCB01-010BT (Bluetooth Class 2) provides a communication range of 33 feet (10m) between the scanner and base or Access Point, depending on the environment. See [Flexible Power Management](#), page 3-12, for information about controlling this range.

## **System Conditions**

The components of the cordless system interact in specific ways as you associate a scanner to a base or Access Point, as you move a scanner out of range, bring a scanner back in range, or swap scanners between two cordless systems. The following information explains the cordless system operating conditions.

### **Linking Process**

Once a scanner is placed into a cordless charge base, the scanner's battery charge status is checked, and software automatically detects the scanner and links it to the base depending on the selected link mode.

Refer to [Linking the Scanner to an Access Point](#), page 3-1, for information about linking to an Access Point.

### **Scanner Is Out of Range**

The cordless scanner is in communication with its base or Access Point, even when it is not transmitting bar code data. Whenever the scanner can't communicate with the base or Access Point for a few seconds, it is out of range. If the scanner is out of range and you scan a bar code, the scanner issues an error tone indicating no communication with the base or Access Point. A cordless charge base can also sound an alarm. Refer to [Out-of-Range Alarm](#), page 3-10.

### **Scanner Is Moved Back Into Range**

The scanner relinks if the scanner or the base or Access Point have been reset, or the scanner comes back into range. If the scanner relinks, you will hear a single chirp when the relinking process (uploading of the parameter table) is complete. Refer to [Out-of-Range Alarm](#) on page 3-10 for further information.

### **Out of Range and Back into Range with Batch Mode On**

The scanner may store a number of symbols (approximately 500 U.P.C. symbols; others may vary) when it is out of range and then send them to the base or Access Point when back in range (see [Batch Mode](#) on page 3-13).

You will not hear a communication error tone in this mode, but you will hear a short buzz when you pull the trigger if the radio communication is not working. Once the radio connection is made, the scanner produces a series of beeps while the data is being transferred to the base or Access Point.

## **Page Button**

When you press the Page button on the base or Access Point, the scanners associated with that base or Access Point will begin beeping (3 short and 1 long beep). If you pull the trigger on a scanner that is beeping in response, or press the Page button on the base or Access Point a second time, all associated scanners will stop beeping. See [Paging](#) on page 3-7 for further information about Page Button settings.

---

## About the Battery



There is a danger of explosion if the batteries are incorrectly replaced. Replace the batteries with only the same or equivalent type recommended by the manufacturer. Dispose of used batteries according to the recycle program for batteries as directed by the governing agency for the country where the batteries are to be discarded.

Power is supplied to the cordless scanner by a rechargeable battery that is integrated in the scanner handle. Batteries are shipped approximately 30% to 60% charged. The battery should be charged for a minimum of 4 hours before initial use to ensure optimal performance.

### Charging Information

The battery is designed to charge while the scanner is positioned in the cordless base unit. Refer to [Base/Access Point LED Sequences and Meaning](#), page 3-5, for an interpretation of the Charge Status indicators. Refer to [Charge Only Mode](#) (page 3-9) if you need to charge a scanner without linking it to the base.

Place the scanner in the base that is connected to an appropriate power supply. Use only a Listed Limited Power Source (LPS) or Class 2 type power supply with output rated 5 to 5.2Vdc, 1A.

*Note: If you are powering the base through the interface cable (for example, a USB cable) and not using an external power supply plugged into the aux port, the current available for charging is reduced and charge times are increased.*

### Battery Recommendations

- The battery is a lithium ion cell and can be used without a full charge, and can also be charged without fully discharging, without impacting the battery life. There is no need to perform any charge/discharge conditioning on this type of battery.
- Keep the base connected to power when the host is not in use.
- Replace a defective battery immediately since it could damage the scanner.
- Although your battery can be recharged many times, it will eventually be depleted. Replace it after the battery is unable to hold an adequate charge.
- If you are not sure if the battery or charger is working properly, send it to Honeywell International Inc. or an authorized service center for inspection. Refer to (see [Customer Support](#) on page -ix) for additional information.



**Caution:**

Use only Honeywell Li-ion battery packs, model number BAT-SCN01, rated 3.7 Vdc, 7.4Whr in this device. Use of any non-Honeywell battery may result in damage not covered by the warranty.

### Safety Precautions for Lithium Batteries

- Do not place batteries in fire or heat the batteries.
- Do not store batteries near fire or other high temperature locations.
- Do not store or carry batteries together with metal objects.
- Do not expose batteries to water or allow the batteries to get wet.
- Do not connect (short) the positive and negative terminals, of the batteries, to each other with any metal object.
- Do not pierce, strike or step on batteries or subject batteries to strong impacts or shocks.
- Do not disassemble or modify batteries.



**Caution:**

Danger of explosion if batteries are incorrectly replaced. Dispose of used batteries according to the recycle program for batteries as directed by the governing agency for the country where the batteries are to be discarded.

### Proper Disposal of the Battery



When the battery has reached the end of its useful life, the battery should be disposed of by a qualified recycler or hazardous materials handler. Do not incinerate the battery or dispose of the battery with general waste materials. You may send the scanner's battery to us. (postage paid). The shipper is responsible for complying with all federal, state, and local laws and regulations related to the packing, labeling, manifesting, and shipping of spent batteries. Contact the Product Service Department ([page ix](#)) for recycling or disposal information. Since you may find that your cost of returning the batteries significant, it may be more cost effective to locate a local recycle/disposal company.



## Beeper and LED Sequences and Meaning

The scanner contains LEDs on the rear of the unit that indicate linking status, decoding state, and battery condition. The base has LEDs on the top of the unit that indicate its power up, communication, and battery charge condition. The red LED = error; green LED = success of any type. Scanners and the CCB01-010BT base have audible indicators as well: 1 razz or error tone = error; 2 beeps = menu change; 1 beep = all other successes.

The table below lists the indication and cause of the LED indication, beeps, and vibrations for the scanner.

### Scanner LED Sequences and Meaning

LED Indication	Beeper Indication	Cause
<b>Normal Operation</b>		
Red Flash	None	Battery low
Green Flash	1 beep	Successful communication or linking
Red, blinking	Razz or error tone	Failed communication
<b>Menu Operation</b>		
Green Flash	2 beeps	Successful menu change
Red, blinking	Razz or error tone	Unsuccessful menu change

### Base/Access Point LED Sequences and Meaning

The base contains a red LED and the Access Point has a blue LED that indicate the status of the unit and verifies its communication with the host system. The base also has a green LED that indicates scanner battery charge condition.

Red or Blue LED - Host Communication	
Red or Blue LED	Communication Condition
Off	USB suspend
On continuously	Power on, system idle
Short blinks in multiple pulses. Occurs while transferring data to/ from the RF module or the Host port.	Receiving data
Green LED - Scanner Battery (base only, does not apply to Access Point)	
Green LED	Charge Condition
Off	Battery not detected or charge suspended
Slow flash, 1 second on, 1 second off	Pre-charge and charging
On continuously	Charge complete
Fast flash, 300 mSec on, 300 mSec off	Charge Error

### Base Power Communication Indicator

To display the power indicator on a base or an Access Point, scan the **Base Power Communication Indicator On** bar code. To turn off the power indicator, scan the **Off** bar code. *Default = On.*



\*:BASRED1.

\* Base Power Communication  
Indicator On



\*:BASRED0.  
Base Power Communication  
Indicator Off

## ***Reset Scanner***

Scanning this bar code reboots the scanner and causes it to relink with the base or Access Point.



RESET\_  
Reset Scanner

## ***Scanning While in Base Cradle***

If you want to be able to scan bar codes while the scanner is in the base cradle, scan the **Scanning in Cradle On** bar code below. If you want to only allow scanning when the scanner is out of the base cradle, scan **Scanning in Cradle Off**. If you want the scanner to shut down when in the base cradle, scan **Shut Down Scanner in Cradle**. *Default = Scanning in Cradle On.*



BT\_SIC0.  
Scanning in Cradle Off



BT\_SIC1.  
\* Scanning in Cradle On



BT\_SIC2.  
Shut Down Scanner in Cradle

## ***Base Charging Modes***

When the base has both an external power supply (plugged into the auxiliary power port) and a host interface cable, it will draw its power from the external power supply. When the base does not have an external power supply, it draws its power from the interface cable. However, the scanner battery charges more slowly from a host interface cable than if auxiliary power were available. Using the following selections, you can specify whether the scanner battery is charged from power supplied via the host interface cable.

When **Base Charge Off** is selected, the scanner battery does not charge when the scanner is in the base cradle.

When **External or Interface Cable Power** is selected, the scanner battery charges from the base's external power supply, if there is one. If there is no external power supply to the base, the scanner battery charges from the interface cable.

When **External Power Only** is selected, the scanner battery only charges from the base's external power supply. If there is no external power supply, the scanner battery does not charge.

*Note: If you are using a cordless charge base in [Presentation Mode](#), **External Power Only** is the only setting available.*

---

Default = External or Interface Cable Power.



BASCHG0.  
Base Charge Off



BASCHG1.  
External or Interface Cable  
Power



BASCHG2.  
External Power Only

## Paging

### Paging Mode

By default, the paging button on the base or Access Point pages the scanners associated with that base or Access Point. If you want the paging button on your base or Access Point to be disabled, scan the **Paging Mode Off** bar code, below. When Paging Mode is off, the base or Access Point will no longer page scanners when the button is pressed. The red LED on the base or blue LED on the Access Point will remain lit to indicate that Paging Mode is off. (This light will go out when the button is pressed, then back on when it's released.) *Default = Paging Mode On.*



BEPPGE1.  
\* Paging Mode On



BEPPGE0.  
Paging Mode Off

### Paging Pitch

When you press the Page button on the base or Access Point, the scanners associated with that base or Access Point will begin beeping (see [Page Button](#) on page 3-3). You can set the pitch of the paging beep for each scanner by scanning one of the following bar codes. *Default = Low.*



BEPPFQ1000.  
\* Low (1000 Hz)



BEPPFQ3250.  
Medium (3250 Hz)



BEPPFQ4200.  
High (4200 Hz)

## **Error Indicators**

### **Beeper Pitch - Base Error**

The CCB01-010BT base can be configured to beep at a particular pitch when an error occurs, such as transmission problems to a host system. The beeper pitch codes modify the pitch (frequency) of the error tone the base emits when there is an error. *Default = Low.*



BASFQ2250.  
\* Razz (250 Hz)



BASFQ23250.  
Medium (3250 Hz)



BASFQ24200.  
High (4200 Hz)

### **Number of Beeps - Base Error**

The number of beeps and LED flashes emitted by the CCB01-010BT base for an error condition can be programmed from 1 - 9. For example, if you program this option to have five error beeps, there will be five error beeps and five LED flashes in response to an error. To change the number of error beeps, scan the bar code below and then scan a digit (1-9) bar code and the **Save** bar code on the [Programming Chart](#) inside the back cover of this manual. *Default = 1.*



BASERR.  
Number of Base Error Beeps/LED Flashes

## **Scanner Report**

Scan the bar code below to generate a report for the connected scanners. The report indicates the port, work group, scanner name, and address. To assign a name to your scanner, refer to [Menu Command Syntax](#), page 9-1.



RPTSCN.  
Scanner Report

---

## Scanner Address

Scan the bar code below to determine the address of the scanner you are using.



## Base or Access Point Address

Scan the bar code below to determine the address of the base or Access Point you are using.



## Scanner Modes

Your scanner is capable of working in single scanner mode, multiple scanner mode, or with Bluetooth devices other than the charge base or Access Point.

### Charge Only Mode

There may be times when you want to charge your scanner, but not link to the base. For example, if a scanner is linked to an Access Point or other Bluetooth device and you need to charge the scanner, but want to retain your existing link.

In order to program the base for Charge Only Mode, you must link a scanner to it. Once the scanner is linked to the base, scan the **Charge Only Mode** bar code. Any subsequent scanners placed in that base will charge without linking to it. The scanner used to program the base remains linked to the base. To unlink this scanner, scan [Unlink Scanner](#) on page 3-10.



*Note: When in Charge Only Mode, the scanner periodically wakes up and beeps. See "Power Up Beeper" on page 4-1 to change this setting.*

If you want to charge a scanner and link to the base, use **Charge and Link Mode**. If the base is programmed for Charge Only Mode, you must link a scanner to it first in order to program it for Charge and Link Mode. Scan the linking bar code on the base to link the scanner, then scan **Charge and Link Mode**. *Default = Charge and Link Mode.*



### Linked Modes

Locked Link Mode and Open Link Mode are the link modes that accommodate different applications. Scan the appropriate bar codes included in the Open Link and Locked Link Mode explanations that follow to switch from one mode to another.

*Default = Open Link Mode.*

---

### ***Locked Link Mode - Single Scanner***

If you link a scanner to a base or an Access Point using the Locked Link Mode, other scanners are blocked from being linked if they are inadvertently placed into the base, or if the Access Point linking bar code is scanned. If you do place a different scanner into a base, it will charge the scanner, but the scanner will not be linked.



To use a different scanner, you need to unlink the original scanner by scanning the **Unlink Scanner** bar code. (See [Scanner Modes](#), page 3-9.)

### ***Open Link Mode - Single Scanner***

When newly shipped or defaulted to factory settings, a scanner is not linked to a base or an Access Point. A link is established when the scanner is placed into a base, or an Access Point linking bar code is scanned. When in Open Link Mode, a new link is established when a new scanner is placed in the base, or you scan an Access Point linking bar code. Each time a scanner is placed into a base or scans an Access Point linking bar code, the scanner becomes linked to the base or Access point and the old scanner is unlinked.



### ***Unlinking the Scanner***

If a base or an Access Point has a scanner linked to it, that scanner must be unlinked before a new scanner can be linked. Once the previous scanner is unlinked, it will no longer communicate with the base or Access Point. To unlink the scanner from a base or an Access Point, scan the **Unlink Scanner** bar code below.



### ***Override Locked Scanner***

If you need to replace a broken or lost scanner that is linked to a base or an Access Point, scan the **Override Locked Scanner** bar code below with a new scanner and place that scanner in the base, or scan the Access Point linking bar code. The locked link will be overridden; the broken or lost scanner's link with the base or Access Point will be removed, and the new scanner will be linked.



### ***Out-of-Range Alarm***

If your scanner is out range of the base, an alarm sounds from both your base and scanner. If your scanner is out range of an Access Point, an alarm sounds from just the scanner. The alarm stops when the scanner is moved closer to the base or Access Point, when the base or Access Point connects to another scanner, or when the alarm duration expires. To activate the alarm

options for the scanner or the base and to set the alarm duration, scan the appropriate bar code below and then set the timeout duration (from 0-3000 seconds) by scanning digits on the [Programming Chart](#) inside the back cover, then scanning **Save**.  
*Default = 0 sec (no alarm).*



*Note: The Access Point does not have a base alarm.*



*Note: If you are out of range when you scan a bar code, you will receive an error tone even if you do not have the alarm set. You receive the error tone since the data could not be communicated to the base or Access Point or the host.*

### Alarm Sound Type

You may change the alarm type for the scanner or a CCB01-010BT base by scanning the appropriate bar code below and then scanning a digit (0-7) bar code and the **Save** bar code on the [Programming Chart](#) inside the back cover of this manual.  
*Default = 0.*

The sounds are as follows:

Setting	Sound
0	3 long beeps, medium pitch
1	3 long beeps, high pitch
2	4 short beeps, medium pitch
3	4 short beeps, high pitch
4	single chirps, medium pitch
5	2 chirps, then 1 chirp, medium pitch
6	single chirps, high pitch
7	2 chirps, then 1 chirp, high pitch



### Scanner Power Time-Out Timer

*Note: Scanner Power Time-out Timer only applies to cordless systems. It does not apply to corded scanners.*

When there is no activity within a specified time period, the scanner enters low power mode. Scan the appropriate scanner power time-out bar code to change the time-out duration (in seconds).

*Note: Scanning zero (0) is the equivalent of setting no time-out.*

---

If there are no trigger pulls during the timer interval, the scanner goes into power down mode. Whenever the trigger is enabled, the timer is reset. If the scanner is placed in the charge base cradle and the battery is in the process of being charged, the scanner will not go into power down mode. *Default = 3600 seconds.*



*Note: When the scanner is in power down mode, pull the trigger to power the unit back up. There will be a set of power up beeps and a delay of up to a few seconds for the radio to join. The scanner will then be ready to use.*

### **Flexible Power Management**

If you are experiencing network performance issues, and suspect the scanner is interfering with other devices, you can turn down the power output of the scanner. This reduces the range between the scanner and a base or an Access Point as shown in the following illustration:

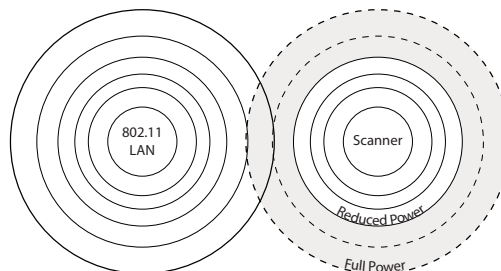



---

Scan one of the bar codes below to set the scanner's power output to **Full Power** (100%), **Medium Power** (35%), **Medium Low Power** (5%), or **Low Power** (1%). *Default = Full Power.*



BT\_TXP100.  
\* Full Power



BT\_TXP35.  
Medium Power



BT\_TXP5.  
Medium Low Power



BT\_TXP1.  
Low Power

## Batch Mode

*Note: Batch Mode is only supported by the Honeywell Charge and Communication Base (CCB) and Honeywell Access Point (AP).*

Batch mode is used to store bar code data when a scanner is out of range of its base or Access Point, or when performing inventory. The data is transmitted to the base or Access Point once the scanner is back in range or when the records are manually transmitted.

*Note: Batch mode has limitations when using multiple scanners to one base or Access Point. If a cordless system is being used in "multiple link mode," where up to 7 scanners are to be connected to one base or Access Point, some accumulated or batched scans could be lost if scanners are constantly being moved in and out of range.*

**Automatic Batch Mode** stores bar code data when the scanner is out of range of the base or Access Point. The data is automatically transmitted to the base or Access Point once the scanner is back in range. When the scanner's buffer space is full, any bar codes scanned generate an error tone. In order to scan bar codes again, the scanner must be moved back into range of the base or Access Point so data can be transmitted.

**Inventory Batch Mode** stores bar code data, whether or not you are in range of the base or Access Point. To transmit the stored data to the base or Access Point, either place the scanner in the base, or scan [Transmit Inventory Records](#) (page 3-17). When the scanner's buffer space is full, any bar codes scanned generate an error tone. In order to scan bar codes again, the data must be transmitted to the base or Access Point. Once the data is transmitted, it is cleared in the scanner.

**Persistent Batch Mode** is the same as Inventory Batch Mode, except that once the data is transmitted to the base or Access Point, it is retained in the scanner. If you want to transmit more than once, you can do so using this mode. In order to clear the scanner's buffer, you must scan [Clear All Codes](#) (see page 3-17).

*Default = Batch Mode Off.*



BATENA0.  
\* Batch Mode Off



BATENA1.  
Automatic Batch Mode



BATENA2.  
Inventory Batch Mode



BATENA3.  
Persistent Batch Mode

### **Batch Mode Beep**

When scanning in [Inventory Batch Mode](#) (page 3-14), the scanner beeps every time a bar code is scanned. When **Batch Mode Beep** is **On**, you will also hear a click when each bar code is sent to the host. If you do not want to hear these clicks, scan **Batch Mode Beep Off**. *Default = Batch Mode Beep On.*



BATBEP0.  
Batch Mode Beep Off



BATBEP1.  
\* Batch Mode Beep On

### **Batch Mode Storage**

When a scanner is storing data during a Batch Mode process, you can select whether the data is stored in Flash memory or in RAM.

**Flash Storage:** The scanner writes any untransmitted data to flash memory prior to powering down. The data will still be there when the scanner powers back up. However, the scanner will power down, even with untransmitted data, if it reaches a power down timeout or if the battery power is very low.

**RAM Storage:** The scanner will not power down while it contains data that has not been transmitted to the base or Access Point, even if it reaches a power down timeout. However, if the scanner runs out of battery power, it will power down and the data will be lost.

*Default = Flash Storage.*



BATNVS1.  
\* Flash Storage



BATNVS0.  
RAM Storage

---

## Batch Mode Quantity

When in Batch Mode, you may wish to transmit the number of multiple bar codes scanned, rather than a single bar code multiple times. For example, if you scan three bar codes called XYZ with **Batch Mode Quantity Off**, when you transmit your data it will appear as XYZ three times. Using **Batch Mode Quantity On** and the **Quantity Codes** (page 3-16), you could output your data as “XYZ, 00003” instead.

*Note: If you wish to format your output, for example, place a CR or tab between the bar code data and the quantity, refer to [Data Formatting](#) beginning on page 6-1.*

Default = Batch Mode Quantity Off.



BATQTY0.

\* Batch Mode Quantity Off



BATQTY1.

Batch Mode Quantity On

## Entering Quantities

Quantity Codes (page 3-16) allow you to enter a quantity for the last item scanned, up to 9999 (default = 1). Quantity digits are shifted from right to left, so if a 5th digit is scanned, the 1st digit scanned is discarded and the 2nd, 3rd and 4th digits are moved to the left to accommodate the new digit.

For example, if the Quantity 5 bar code is scanned after the quantity has been set to 1234, then the 1 is dropped, the quantity will be 2345.

**Example:** Add a quantity of 5 for the last item scanned.

1. Scan the item's bar code.
2. Scan the quantity 5 bar code.

**Example:** Add a quantity of 1,500 for the last item scanned.

1. Scan the item's bar code.
2. Scan the quantity 1 bar code.
3. Scan the quantity 5 bar code.
4. Scan the quantity 0 bar code.
5. Scan the quantity 0 bar code.

**Example:** Change a quantity of 103 to 10.

To correct an incorrect quantity, scan the quantity 0 bar code to replace the incorrect digits, then scan the correct quantity bar codes.

1. Scan the quantity 0 bar code to change the quantity to 1030.
2. Scan the quantity 0 bar code to change the quantity to 0300.
3. Scan the quantity 1 bar code to change the quantity to 3001.
4. Scan the quantity 0 bar code to change the quantity to 0010.

Default = 1.

## Quantity Codes



BATNUM0.

0



BATNUM2.

2



BATNUM4.

4



BATNUM6.

6



BATNUM8.

8



BATNUM1.

1



BATNUM3.

3



BATNUM5.

5



BATNUM7.

7



BATNUM9.

9

### ***Batch Mode Output Order***

When batch data is transmitted, select whether you want that data sent as **FIFO** (first-in first-out), or **LIFO** (last-in first-out).  
*Default = Batch Mode FIFO.*



BATLIFO.

\* Batch Mode FIFO



BATLIF1.

**Batch Mode LIFO**

---

## **Total Records**

If you wish to output the total number of bar codes scanned when in Batch Mode, scan **Total Records**.



## **Delete Last Code**

If you want to delete the last bar code scanned when in Batch Mode, scan **Delete Last Code**.



## **Clear All Codes**

If you want to clear the scanner's buffer of all data accumulated in Batch Mode, scan **Clear All Codes**.



## **Transmit Records to Host**

If you are operating in Inventory Batch Mode (see [Inventory Batch Mode](#) on page 3-14), you must scan the following bar code to transmit all the stored data to the host system.



## **Batch Mode Transmit Delay**

Sometimes when accumulated scans are sent to the host system, the transmission of those scans is too fast for the application to process. To program a transmit delay between accumulated scans, scan one of the following delays. *Default = Off.*

*Note: In most cases, a short (250 ms (milliseconds)) delay is ideal, however, longer delays may be programmed. Contact Technical Support ([page ix](#)) for additional information.*





## Multiple Scanner Operation

*Note: Multiple Scanner Operation Mode allows you to link up to 7 scanners to one base or Access Point. You cannot join an 8th scanner until you unlink one of the 7 scanners or take a scanner out of range.*

To put the scanner in multiple scanner mode, scan the bar code below. Once you scan this bar code, the scanner is unlinked from the base or Access Point and must either be placed into the base, or you must scan the Access Point linking bar code in order to relink.



## Scanner Name

You may assign a name to each scanner you are using for identification purposes. For example, you may want to have a unique identifier for a scanner that is receiving imaging commands sent from the base or Access Point.

The default name is in the format “ScannerName\_Model\_SN\_XXXXXXXXXX” If you have more than one scanner linked to a base, and they all have the same name, the first scanner linked to the base receives commands. When renaming a series of scanners with identical names, unlink all except one of the scanners from the base.

Perform the rename operation using either the bar codes on [page 3-19](#), or by sending the serial command **:ScannerName:BT\_NAMNewName**. where *ScannerName* is the current name of the scanner, and *NewName* is the new name for the scanner. If you wish to change the names of additional scanners, link them one at a time and repeat the **:ScannerName:BT\_NAMNewName**. command for each scanner.

To rename scanners with sequential, numeric names, scan the bar codes below. Scan the **Reset** code after each name change and wait for the scanner to relink to the base or Access Point before scanning a bar code to rename the next scanner.





You may also scan the **Scanner Name** bar code below and scan a number for the scanner name. For example, if you wanted to name the linked scanner “312,” you would scan the bar code below, scan the **3**, **1**, and **2** bar codes on the [Programming Chart](#) inside the back cover of this manual, then scan **Save**. Scan the **Reset** bar code and wait for the scanner to relink to the base.



## ***Application Work Groups***

Your cordless system can have up to 7 scanners linked to one base or Access Point. You can also have up to 7 work groups. If you want to have all of the scanners’ settings programmed alike, you don’t need to use more than 1 work group. If you want each scanner to have unique settings (e.g., beeper volume, prefix/suffix, data formatter), then you may program each scanner to its own unique work group and may program each scanner independently. For example, you might want to have multiple work groups in a retail/warehouse application where you need to have different data appended to bar codes used in the warehouse area versus the retail area. You could assign all the scanners in the retail area to one work group and those in the warehouse to another. Consequently, any desired changes to either the retail or warehouse area would apply to all scanners in that particular work group. Honeywell’s online configuration tool, EZConfig-Scanning ([page 2](#)), makes it easy for you to program your system for use with multiple scanners and multiple work groups.

The scanner keeps a copy of the menu settings it is using. Whenever the scanner is connected or reconnected to a base or an Access Point, the scanner is updated with the latest settings from the base or Access Point for its work group. The scanner also receives menu setting changes processed by the base or Access Point. If a scanner is removed from a base or an Access Point and placed into another base or linked to another Access Point, it will be updated with the new base/Access Point settings for whatever work group to which that the scanner was previously assigned. For example, if the scanner was in work group 1 linked to the first base, it will be placed in work group 1 in the second base with the associated settings.

---

## Application Work Group Selection

This programming selection allows you to assign a scanner to a work group by scanning the bar code below. You may then program the settings (e.g., beeper volume, prefix/suffix, data formatter) that your application requires. *Default = Group 0.*



GRPSEL0.  
\* Group 0



GRPSEL1.  
Group 1



GRPSEL2.  
Group 2



GRPSEL3.  
Group 3



GRPSEL4.  
Group 4



GRPSEL5.  
Group 5



GRPSEL6.  
Group 6

## Resetting the Factory Defaults: All Application Work Groups

The following bar code defaults all of the work groups to the factory default settings.



PAPDFT&  
Factory Default Settings:  
All Work Groups

To see what the factory default settings are, refer to the table of [Menu Commands](#), beginning on page 9-3. The standard product default settings for each of the commands are indicated by an asterisk (\*).

*Note: Scanning this bar code also causes both the scanner and the base or Access Point to perform a reset and become unlinked. The scanner must be placed in the base, or the Access Point linking bar code must be scanned to re-establish the link. Refer to [Scanner Modes](#), page 3-9 for additional information.*

*If your scanner is in multiple scanner mode, you will hear up to 30 seconds of beeping while all scanners are relinked to the base or Access Point and the settings are changed.*



---

## Resetting the Custom Defaults: All Application Work Groups

If you want the custom default settings restored to all of the work groups, scan the **Custom Product Default Settings** bar code below. (If there are no custom defaults, it will reset the work groups to the factory defaults.) See "Setting Custom Defaults" on page 1-7 for further information about custom defaults.



PAPDFT.

**Custom Default Settings:  
All Work Groups**

*Note: Scanning this bar code also causes both the scanner and the base or Access Point to perform a reset and become unlinked. The scanner must be placed in its base, or the Access Point linking bar code must be scanned to re-establish the link. Refer to [Scanner Modes](#), page 3-9 for additional information.*

*If your scanner is in multiple scanner mode, you will hear up to 30 seconds of beeping while all scanners are relinked to the base or Access Point and the settings are changed.*

## Pairing the Scanner with Bluetooth Devices

The scanner can be paired with Bluetooth devices such as personal computers, laptops, and tablets.

1. Scan the appropriate **Bluetooth HID Keyboard Connect** bar code below.



PAPBTH.

**Bluetooth HID Keyboard  
Connect**



PAPJKB.

**Bluetooth HID Japanese  
Keyboard Connect**

2. Set your personal computer, laptop, or tablet so it searches for other Bluetooth devices. (Refer to your device's User's Guide for pairing instructions.)
3. Once your personal computer, laptop, or tablet has located the scanner, select the scanner name. Some personal computers, laptops, or tablets will automatically pair with the scanner. If your device automatically pairs with the scanner, it displays a successful pairing message and you do not need to continue to the next step.
4. If your personal computer, laptop, or tablet does not automatically pair with the scanner, a PIN is displayed. This PIN must be scanned within 60 seconds. You must quickly scan Bluetooth PIN Code below, then scan the numeric bar code(s) for the PIN code from the chart below, then scan the **Save** bar code.



BT\_PIN.

**Bluetooth PIN Code**



KDK

0



K1K

1



Your personal computer, laptop, or tablet should now be paired with the scanner.

Once the scanner battery is charged and you have paired it, you may begin scanning bar codes. Verify the scanner operation by scanning a bar code from the [Sample Symbols](#) in the back of this manual.

### ***Virtual Keyboard***

Once your scanner has been connected directly to an iPad, smart phone, or laptop, you can toggle the virtual keyboard on your device with a quick double pull of the scanner trigger.

---

## **Bluetooth HID Keyboard Disconnect**

If your scanner has been connected directly to an iPad, smart phone, or laptop using [Bluetooth HID Keyboard Connect](#) (page 3-21), you must disconnect it in order to once again communicate with the base or Access Point. Scan the **Bluetooth HID Keyboard Disconnect** bar code to unlink the scanner from the currently linked host. Scan the linking bar code on the base or Access Point to relink the scanner.



PAPSPP.

**Bluetooth HID Keyboard Disconnect**

## **Bluetooth Serial Port - PCs/Laptops**

Scanning the **Non-Base BT Connection** bar code below unlinks your scanner and puts it into a discoverable state. Once the scanner searches for and connects with a Bluetooth host, the scanner stores the connection to the host device address and switches virtual COM ports. This allows the scanner to automatically relink to the host if the connection is lost.



BT\_TRM0;BT\_DNG5.

**Non-Base BT Connection**

## **PDAs/Mobility Systems Devices**

You may also use the scanner with a PDA or a Honeywell Mobility Systems device. Scan the bar code below and follow the instructions supplied with your Bluetooth device to locate the scanner, and connect with it.



BT\_TRM0;BT\_DNG1.

**BT Connection - PDA/Mobility Systems Device**

## **Changing the Scanner's Bluetooth PIN Code**

Some devices require a PIN code as part of the Bluetooth security features. Your scanner's default PIN is 1234, which you may need to enter the first time you connect to your PDA or PC. The PIN code must be between 1 and 16 characters. To change the PIN, scan the bar code below and then scan the appropriate numeric bar codes from the [Programming Chart](#) inside the back cover of this manual. Scan **Save** to save your selection.



BT\_PIN.

**Bluetooth PIN**

## **Minimizing Bluetooth/ISM Band Network Activity**

The settings described below can help you customize the relinking behavior of the cordless area-imaging system to obtain the best compromise between convenience and low interference.

*Note: ISM band refers to the 2.4 to 2.48 GHz frequency band used by wireless networks, cordless phones, and Bluetooth.*

## Auto Reconnect Mode

Auto Reconnect controls whether or not the scanner automatically begins the relink process when a loss of connection is detected. When the **Auto Reconnect On** bar code is scanned, the scanner begins the relink process immediately, without user intervention. *Default = Auto Reconnect On.*



BT\_ACM1.  
\* Auto Reconnect On



BT\_ACM0.  
Auto Reconnect Off

*Note: If you are connecting to a Bluetooth Interface Module, set Auto Reconnect to Off.*

The table below shows the results of the Auto Reconnect On and Off settings:

Event	Auto Reconnect On	Auto Reconnect Off
Scanner out of range	Relink occurs automatically. If maximum number of link attempts is unsuccessful, then the scanner must be relinked by either pulling the trigger, placing the scanner in the base, or scanning the Access Point linking bar code. (See "Maximum Link Attempts" on page 3-24.)	The scanner is relinked by pulling the trigger, or scanning the Access Point linking bar code.
Base or Access point reset (firmware upgrade or power cycle)	Scanner behaves as if out of range.	No attempt to relink made while base or Access Point is powered off. Trigger must be pulled to initiate relinking.
Scanner power down due to Power Time-Out Timer setting (see <a href="#">page 3-11</a> )	Trigger must be pulled, Access Point linking bar code must be scanned, or the scanner must be placed in the base unit to relink. (Note: scanner relinks on power up, but powers on due to one of the above actions.)	
Scanner reset due to firmware upgrade	Relink occurs automatically.	
Scanner reset due to battery change	Relink occurs automatically.	
Scanner placed in different base unit	Relink to new base occurs automatically.	

## Maximum Link Attempts

The Maximum Link Attempts setting controls the number of times the scanner tries to form a connection with a base or an Access Point. During the connection setup process, the scanner transmits in order to search for and connect to a base or an Access Point. In order to prevent continuous transmissions that could interfere with other users of the ISM band, the number of attempts to connect is limited by this setting. After the maximum number of attempts is reached, the scanner will not attempt to reconnect to a base or an Access Point. Pressing the trigger, scanning an Access Point linking bar code, or placing the scanner in the cradle resets the attempt count and the scanner will again try to link.

---

Scan the **Maximum Link Attempts** bar code, then scan the number of attempts for the setting (from 0-100) from the inside back cover. Scan Save to save the setting. *Default = 0.*



*Note: When Auto Reconnect Mode is On, setting Maximum Link Attempts to zero will cause the scanner to try to link until the Power Time-Out Timer setting (see [page 3-11](#)) expires. When Auto Reconnect Mode is Off, setting Maximum Link Attempts to zero will cause the scanner to only attempt linking one time after a trigger pull.*

### **Relink Time-Out**

Relink Time-Out controls the idle time between relink attempts. An attempt to link a scanner to a base or an Access Point typically lasts up to 5 seconds. This is the time when the scanner is actually attempting a contact. Relink Time-Out controls the amount of time, in seconds, that elapses between the end of one connection attempt and the start of the next.

*Note: The length of time for an attempt depends on the number of scanners connected to a base unit or Access Point. An extra 7 seconds may be required when a connection is successful.*

Scan the **Relink Time-Out** bar code, then scan the number of seconds for the setting (from 1-100) from the inside back cover. Scan Save to save the setting. *Default = 3 seconds.*



### **Bluetooth/ISM Network Activity Examples**

#### **Default values**

When the scanner goes out of range, the scanner repeatedly attempts to connect to the base unit or Access Point. Each attempt consists of approximately 5 seconds of active time followed by 3 seconds of idle time. After one hour, the scanner powers off and batch mode data is lost.

#### **Maximum Link Attempts set to 15**

##### **Other values at default setting**

When the scanner goes out of range, 15 attempts are made to link to the base unit or Access Point. Each attempt consists of approximately 5 seconds of active time followed by 3 seconds of idle time. After 15 cycles ( $8 \times 15 = 120$ ), or about 2 minutes, the scanner stops trying to connect to the base or Access Point, but retains any bar codes that may have been saved in batch mode. After one hour, the scanner powers off and batch mode data is lost.

#### **Auto Reconnect Mode set to 0**

##### **Maximum Link Attempts set to 15**

##### **Other values at default setting**

When the scanner goes out of range, no action is taken to relink. When the trigger is pulled, 15 attempts are made to link to the base or Access Point. Each attempt consists of approximately 5 seconds of active time followed by 3 seconds of idle time. After 15 cycles ( $8 \times 15 = 120$ ), or about 2 minutes, the scanner stops trying to connect to the base or Access Point, but retains any bar codes that may have been saved in batch mode. After one hour, the scanner powers off and batch mode data is lost. Refer to [Auto Reconnect Mode](#), page 3-24, to review other events that can start the relink process.

#### **Auto Reconnect Mode set to 1**

##### **Maximum Link Attempts set to 0**

##### **Relink Time-Out set to 10**

##### **Scanner Power Time-Out Timer set to 1800**

*Note: See [Scanner Power Time-Out Timer](#) on page 3-11.*

The scanner attempts to connect to the base or Access Point every 15 seconds, measured from one attempt start to the next attempt start. After one half hour, the scanner powers off.

---

## Host Acknowledgment

Some applications require that the host terminal (or server) validate incoming bar code data (database look-up) and provide acknowledgment to the scanner whether or not to proceed. In Host ACK Mode, the scanner waits for this acknowledgment after each scan. Visual and audible acknowledgments provide valuable feedback to the scan operator. The Host ACK functionality is controlled via a number of pre-defined escape commands that are sent to the scanner to make it behave in different ways.

*Note: System performance degrades when using Host ACK at rates lower than 9600 baud.*

The following criteria must be met for the Host ACK to work correctly:

- The cordless system must be configured for Host Port RS232 (terminal ID = 000) or USB COM Emulation (terminal ID = 130).
- RTS/CTS is defaulted off. You must enable it if the host system requires it.
- Host ACK must be set to On ([page 27](#)).
- A comma must be used as a terminator.
- The host terminal software must be capable of interpreting the bar code data, make decisions based on the data content, and send out appropriate escape commands to the scanner.

Escape commands are addressed to the scanner via "Application Work Groups." Once a command is sent, all scanners in a group respond to that command. Because of this, **it is recommended that each scanner is assigned to its own group in Host ACK mode.**

The commands to which the scanner responds are listed on [page 3-27](#). The **[ESC]** is a **1B** in hex. A typical command string is **y [ESC] x**, where "y" is the application work group number, "[ESC] x" is the escape command, and the comma is the terminator, which is required. (When "y" is not specified, the command is sent to the default Application Work Group 0.)

**Example:** Commands may be strung together to create custom response sequences. An example of a command string is listed below.

```
0[ESC]4,[ESC]5,[ESC]6,
```

The above example will make a scanner that is in application work group zero beep low, then medium, then high.

**Example:** A good read beep is required for any item on file, but a razz or error tone is required if the item is not on file. In this case,

```
[ESC]7, is sent to the host for an on-file product
```

```
[ESC]8,[ESC]8, is sent to the host for a not-on-file product
```

When a bar code is scanned, the scanner enters a timeout period until either the host ACK sequence is received, or the timeout expires (in 10 seconds, by default).

Once Host ACK is enabled, the system works as follows when a bar code is scanned:

- The scanner reads the code and sends data to the base or Access Point to transmit to the host system. No audible or visual indication is emitted until the scanner receives an escape command. The scanner read illumination goes out when there's a successful read.
- Scanner operation is suspended until 1) a valid escape string is received from the host system or 2) the scanner times out.
- Once condition 1 or 2 above has been met, the scanner is ready to scan again, and the process repeats.

A timeout occurs if the scanner does not receive a valid escape command within the timeout period. A timeout is indicated by an error tone. If a timeout occurs, the operator should check the host system to understand why a response to the scanner was not received.

---

## Host ACK On/Off



HSTACK1.  
Host ACK On



HSTACK0.  
\* Host ACK Off

## Host ACK Timeout

You can set a timeout for the length of time the scanner waits for a valid escape command when using Host Acknowledgment Mode. Set the length (in seconds) for a timeout by scanning the following bar code, then setting the timeout (from 1-90 seconds) by scanning digits from the [Programming Chart](#), then scanning [Save](#). *Default = 10.*



HSTATO.  
Host ACK Timeout

## Host ACK Responses

Command	Action
[ESC] a,	Double beeps to indicate a successful menu change was made.
[ESC] b,	Razz or error tone to indicate a menu change was unsuccessful.
[ESC] 1,	The green LED illuminates for 135 milliseconds followed by a pause.
[ESC] 2,	The green LED illuminates for 2 seconds followed by a pause.
[ESC] 3,	The green LED illuminates for 5 seconds followed by a pause.
[ESC] 4,	Emits a beep at a low pitch.
[ESC] 5,	Emits a beep at a medium pitch.
[ESC] 6,	Emits a beep at a high pitch.
[ESC] 7,	Beeps to indicate a successful decode and communication to host.
[ESC] 8,[ESC] 8,	Razz or error tone to indicate a decode/communication to host was unsuccessful.





## Input/Output Settings

### Power Up Beeper

The scanner can be programmed to beep when it's powered up. If you are using a cordless system, the base can also be programmed to beep when it is powered up. Scan the **Off** bar code(s) if you don't want a power up beep. *Default = Power Up Beeper On - Scanner.*



BEPPWR0.

Power Up Beeper Off -  
Scanner



BEPPWR1.

\* Power Up Beeper On -  
Scanner



BASPWR0.

Power Up Beeper Off -  
Cordless Base



BASPWR1.

\* Power Up Beeper On -  
Cordless Base

### Beep on BEL Character

You may wish to force the scanner to beep upon a command sent from the host. If you scan the **Beep on BEL On** bar code below, the scanner will beep every time a BEL character is received from the host. *Default = Beep on BEL Off.*



BELBEP0.

\*Beep on BEL Off



BELBEP1.

Beep on BEL On

### Trigger Click

To hear an audible click every time the scanner trigger is pressed, scan the **Trigger Click On** bar code below. Scan the **Trigger Click Off** code if you don't wish to hear the click. (This feature has no effect on serial or automatic triggering.) *Default = Trigger Click Off.*



BEPTRG0.

\*Trigger Click Off



## **Good Read and Error Indicators**

### **Beeper – Good Read**

The beeper may be programmed **On** or **Off** in response to a good read. Turning this option off, only turns off the beeper response to a good read indication. All error and menu beeps are still audible. *Default = Beeper - Good Read On.*



### **Beeper Volume – Good Read**

The beeper volume codes modify the volume of the beep the scanner emits on a good read. *Default = High.*



### **Beeper Pitch – Good Read**

The beeper pitch codes modify the pitch (frequency) of the beep the scanner emits on a good read. *Default = Medium.*





### ***Beeper Pitch – Error***

The beeper pitch codes modify the pitch (frequency) of the sound the scanner emits when there is a bad read or error. *Default = Razz.*



### ***Beeper Duration – Good Read***

The beeper duration codes modify the length of the beep the scanner emits on a good read. *Default = Normal.*



### ***LED – Good Read***

The LED indicator can be programmed **On** or **Off** in response to a good read. *Default = On.*



---

### **Number of Beeps – Good Read**

The number of beeps of a good read can be programmed from 1 - 9. The same number of beeps will be applied to the beeper and LED in response to a good read. For example, if you program this option to have five beeps, there will be five beeps and five LED flashes in response to a good read. The beeps and LED flashes are in sync with one another. To change the number of beeps, scan the bar code below and then scan a digit (1-9) bar code and the **Save** bar code on the [Programming Chart](#) inside the back cover of this manual. *Default = 1.*



**Number of Good Read Beeps/LED Flashes**

### **Number of Beeps – Error**

The number of beeps and LED flashes emitted by the scanner for a bad read or error can be programmed from 1 - 9. For example, if you program this option to have five error beeps, there will be five error beeps and five LED flashes in response to an error. To change the number of error beeps, scan the bar code below and then scan a digit (1-9) bar code and the **Save** bar code on the [Programming Chart](#) inside the back cover of this manual. *Default = 1.*



**Number of Error Beeps/LED Flashes**

### **Good Read Delay**

This sets the minimum amount of time before the scanner can read another bar code. *Default = 0 ms (No Delay).*



### **User-Specified Good Read Delay**

If you want to set your own length for the good read delay, scan the bar code below, then set the delay (from 0-30,000 milliseconds) by scanning digits from the inside back cover, then scanning **Save**.



**User-Specified Good Read Delay**

---

## Manual Trigger Mode

When in manual trigger mode, the scanner scans until a bar code is read, or until the trigger is released. *Default = Manual Trigger-Normal.*



PAPHHF.

\* Manual Trigger - Normal

## LED Illumination - Manual Trigger

If you wish to set the illumination LED brightness, scan one of the bar codes below. This sets the LED illumination for the scanner when the trigger is pressed. *Default = High.*

*Note: This feature is not supported by the VG1450g2DHR.*

*Note: The LEDs are like a flash on a camera. The lower the ambient light in the room, the brighter the LEDs need to be so the scanner can “see” the bar codes.*



PWRNOL7.

Low



PWRNOL15.

Medium



PWRNOL50.

Medium High



PWRNOL150.

\* High

## Serial Trigger Mode

You can activate the scanner either by pressing the trigger, or using a serial trigger command (see [Trigger Commands](#) on page 9-3). When in serial mode, the scanner scans until a bar code has been read or until the deactivate command is sent. The scanner can also be set to turn itself off after a specified time has elapsed (see [Read Time-Out](#), which follows).

### Read Time-Out

Use this selection to set a time-out (in milliseconds) of the scanner's trigger when using serial commands to trigger the scanner. Once the scanner has timed out, you can activate the scanner either by pressing the trigger or using a serial trigger command. After scanning the **Read Time-Out** bar code, set the time-out duration (from 0-300,000 milliseconds) by scanning digits on the [Programming Chart](#) inside the back cover, then scanning **Save**. *Default = 30,000 ms.*



TRGSTO.

Read Time-Out

---

## Presentation Mode

Presentation Mode uses ambient light to detect bar codes. The LED dims until a bar code is presented to the scanner, then the LED brightens to read the code. If the light level in the room is not high enough, Presentation Mode may not work properly.

*Note: If you are using a cordless charge base in Presentation Mode, the battery will not charge unless the power supply is plugged into the base's auxiliary power port.*

Scan the following bar code to program your scanner for Presentation Mode.



PAPPST.

**Presentation Mode**

## Idle Illumination - Presentation Mode

Scan one of the bar codes below to set the LED illumination for the scanner when it is in an idle state in Presentation Mode. *Default = High.*

*Note: This feature is not supported by the VG1450g2DHR.*

*Note: If you use one of the lower Idle Illumination settings, and there is not enough ambient light, the scanner may have difficulty detecting when a bar code is presented to it. If the scanner has difficulty "waking up" to read bar codes, you may need to set the Idle Illumination to a brighter setting.*



PWRIDL7.

**Low**



PWRIDL15.

**Medium**



PWRIDL50.

**\* High**

## Presentation Sensitivity

Presentation Sensitivity is a numeric range that increases or decreases the scanner's reaction time to bar code presentation. To set the sensitivity, scan the **Sensitivity** bar code, then scan the degree of sensitivity (from 0-20) from the inside back cover, and **Save**. 0 is the most sensitive setting, and 20 is the least sensitive. *Default = 1.*



TRGPMS.

**Sensitivity**

## Presentation Centering

Use Presentation Centering to narrow the scanner's field of view when it is in the stand to make sure the scanner reads only those bar codes intended by the user. For instance, if multiple codes are placed closely together, Presentation Centering will insure that only the desired codes are read.

*Note: To adjust centering when the scanner is hand-held, see [Centering](#) (page 4-14).*

If a bar code is not touched by a predefined window, it will not be decoded or output by the scanner. If Presentation Centering is turned on by scanning **Presentation Centering On**, the scanner only reads codes that pass through the centering window you specify using the **Top of Presentation Centering Window**, **Bottom of Presentation Centering Window**, **Left**, and **Right of Presentation Centering Window** bar codes.

In the example below, the white box is the centering window. The centering window has been set to 20% left, 30% right, 8% top, and 25% bottom. Since Bar Code 1 passes through the centering window, it will be read. Bar Code 2 does not pass through the centering window, so it will not be read.

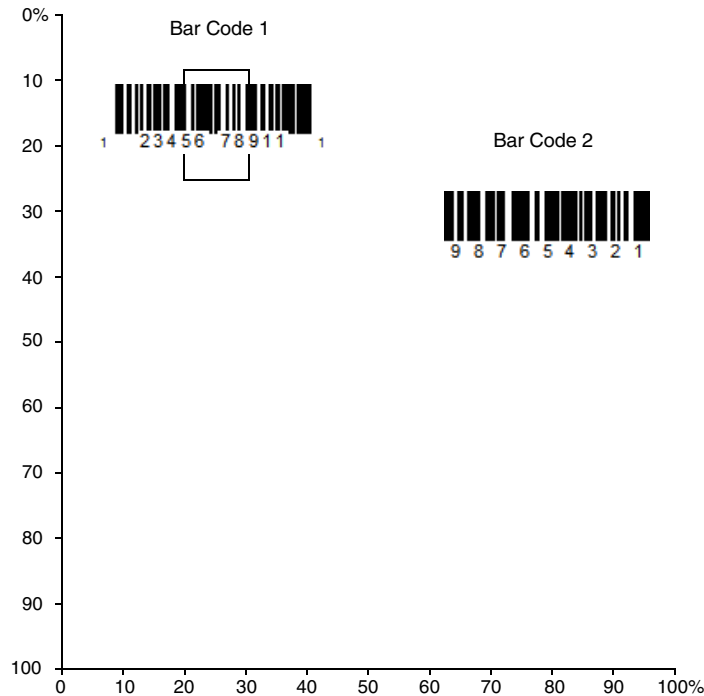

*Note: A bar code needs only to be touched by the centering window in order to be read. It does not need to pass completely through the centering window.*

Scan **Presentation Centering On**, then scan one of the following bar codes to change the top, bottom, left, or right of the centering window. Then scan the percent you want to shift the centering window using digits on the inside back cover of this manual. Scan **Save**. *Default Presentation Centering = 40% for Top and Left, 60% for Bottom and Right.*



PDCWIN1.  
**Presentation Centering On**



PDCWIND.  
**\* Presentation Centering Off**



PDCTOP.  
**Top of Presentation Centering Window**



## ***In-Stand Sensor Mode***

This feature senses when the scanner is removed from the stand and tells it to begin manual triggering. When **Sensor On** is enabled, the scanner defaults to Presentation Mode when it is in the stand, and to Manual Trigger Mode when it is removed from the stand. *Default = Sensor On.*



## ***Poor Quality Codes***

### ***Poor Quality 1D Codes***

This setting improves the scanner's ability to read damaged or badly printed linear bar codes. When **Poor Quality 1D Reading On** is scanned, poor quality linear bar code reading is improved, but the scanner's snappiness is decreased, making it less aggressive when reading good quality bar codes. This setting does not affect 2D bar code reading. *Default = Poor Quality 1D Reading Off.*

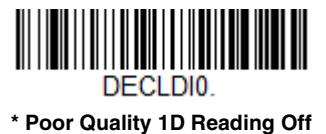



---

## Poor Quality PDF Codes

This setting improves the scanner's ability to read damaged or badly printed PDF codes by combining information from multiple images. When **Poor Quality PDF On** is scanned, poor quality PDF code reading is improved, but the scanner's snap-piness is decreased, making it less aggressive when reading good quality bar codes. This setting does not affect 1D bar code reading. *Default = Poor Quality PDF Reading Off.*



Poor Quality PDF Reading On



\* Poor Quality PDF Reading Off

## CodeGate®

When CodeGate is **On**, the trigger is used to allow decoded data to be transmitted to the host system. The scanner remains on, scanning and decoding bar codes, but the bar code data is not transmitted until the trigger is pressed. When CodeGate is **Off**, bar code data is transmitted when it is decoded. *Default = CodeGate Off Out-of-Stand.*



\* CodeGate Off  
Out-of-Stand



CodeGate On  
Out-of-Stand

## Mobile Phone Read Mode

When this mode is selected, your scanner is optimized to read bar codes from mobile phone or other LED displays. However, the speed of scanning printed bar codes may be slightly lower when this mode is enabled



Hand Held Scanning - Mobile  
Phone

*Note: To turn off Mobile Phone Read Mode, scan the Manual Trigger Mode bar code (see page 4-5).*

## Hands Free Time-Out

The Scan Stand and Presentation Modes are referred to as "hands free" modes. If the scanner's trigger is pressed when using a hands free mode, the scanner changes to manual trigger mode. You can set the time the scanner should remain in manual trigger mode by setting the Hands Free Time-Out. Once the time-out value is reached, (if there have been no further trigger presses) the scanner reverts to the original hands free mode.

---

Scan the **Hands Free Time-Out** bar code, then scan the time-out duration (from 0-300,000 milliseconds) from the inside back cover, and **Save**. *Default = 5,000 ms.*



TRGPT0.

**Hands Free Time-Out**

## ***Reread Delay***

This sets the time period before the scanner can read the *same* bar code a second time. Setting a reread delay protects against accidental rereads of the same bar code. Longer delays are effective in minimizing accidental rereads. Use shorter delays in applications where repetitive bar code scanning is required. Reread Delay only works when in **Presentation Mode** (see page 4-6). *Default = Medium.*



DLYRRD500.

**Short (500 ms)**



DLYRRD750.

**\* Medium (750 ms)**



DLYRRD1000.

**Long (1000 ms)**



DLYRRD2000.

**Extra Long (2000 ms)**

## ***User-Specified Reread Delay***

If you want to set your own length for the reread delay, scan the bar code below, then set the delay (from 0-30,000 milliseconds) by scanning digits from the inside back cover, then scanning **Save**.



DLYRRD.

**User-Specified Reread Delay**

## ***2D Reread Delay***

Sometimes 2D bar codes can take longer to read than other bar codes. If you wish to set a separate Reread Delay for 2D bar codes, scan one of the programming codes that follows. **2D Reread Delay Off** indicates that the time set for **Reread Delay** is used for both 1D and 2D bar codes. *Default = 2D Reread Delay Off.*



DLY2RR0.

**\* 2D Reread Delay Off**



## Character Activation Mode

You may use a character sent from the host to trigger the scanner to begin scanning. When the activation character is received, the scanner continues scanning until either the [Character Activation Timeout](#) (page 4-12), the deactivation character is received (see [Deactivation Character](#) on page 4-12), or a bar code is transmitted. Scan the following **On** bar code to use character activation, then use Activation Character (following) to select the character you will send from the host to start scanning.

*Default = Off.*



## Activation Character

This sets the character used to trigger scanning when using Character Activation Mode. On the [ASCII Conversion Chart \(Code Page 1252\)](#), page A-3, find the hex value that represents the character you want to use to trigger scanning. Scan the following bar code, then use the [Programming Chart](#) to read the alphanumeric combination that represents that ASCII character. Scan **Save** to finish.



---

## End Character Activation After Good Read

After a bar code is successfully detected and read from the scanner, the aimer can be programmed either to remain on and scanning, or to turn off. When **End Character Activation After Good Read** is enabled, the aimer turns off and stops scanning after a good read. If you scan **Do Not End Character Activation After Good Read**, the aimer remains on after a good read. *Default = End Character Activation After Good Read.*



## Character Activation Timeout

You can set a timeout for the length of time the aimer remains on and attempting to decode bar codes when using Character Activation Mode. Set the length (in milliseconds) for a timeout by scanning the following bar code, then setting the timeout (from 1-65535 milliseconds) by scanning digits from the [Programming Chart](#), then scanning **Save**. *Default = 5000 ms.*



## Character Deactivation Mode

If you have sent a character from the host to trigger the scanner to begin scanning, you can also send a deactivation character to stop scanning. Scan the following **On** bar code to use character deactivation, then use Deactivation Character (following) to select the character you will send from the host to terminate scanning. *Default = Off.*



## Deactivation Character

This sets the character used to terminate scanning when using Character Deactivation Mode. On the [ASCII Conversion Chart \(Code Page 1252\)](#), page A-3, find the hex value that represents the character you want to use to terminate scanning. Scan the following bar code, then use the [Programming Chart](#) to read the alphanumeric combination that represents that ASCII character. Scan **Save** to finish.



---

## ***Illumination Lights***

If you want the illumination lights on while reading a bar code, scan the **Lights On** bar code, below. However, if you want to turn just the lights off, scan the **Lights Off** bar code. *Default = Lights On.*

*Note: This setting does not affect the aimer light. The aiming light can be set using Aimer Mode (below).*



SCNLED1.  
\* Lights On



SCNLED0.  
Lights Off

## ***Aimer Delay***

The aimer delay allows a delay time for the operator to aim the scanner before the picture is taken. Use these codes to set the time between when the trigger is pulled and when the picture is taken. During the delay time, the aiming light will appear, but the LEDs won't turn on until the delay time is over. *Default = Off.*



SCNDLY200.  
200 milliseconds



SCNDLY400.  
400 milliseconds



SCNDLY0.  
\* Off (no delay)

## ***User-Specified Aimer Delay***

If you want to set your own length for the duration of the delay, scan the bar code below, then set the time-out by scanning digits (0 - 4,000 ms) from the [Programming Chart](#) inside the back cover of this manual, then scan **Save**.



SCNDLY.  
Delay Duration

## ***Aimer Mode***

This feature allows you to turn the aimer on and off. When the **Interlaced** bar code is scanned, the aimer is interlaced with the illumination LEDs. *Default = Interlaced.*



SCNAIM0.  
Off



## Centering

Use Centering to narrow the scanner's field of view to make sure that when the scanner is hand-held, it reads only those bar codes intended by the user. For instance, if multiple codes are placed closely together, centering will insure that only the desired codes are read.

*Note: To adjust centering when the scanner is in the stand, see [Presentation Centering](#) (page 4-6).*

If a bar code is not touched by a predefined window, it will not be decoded or output by the scanner. If centering is turned on by scanning **Centering On**, the scanner only reads codes that pass through the centering window you specify using the **Top of Centering Window**, **Bottom of Centering Window**, **Left**, and **Right of Centering Window** bar codes.

In the example below, the white box is the centering window. The centering window has been set to 20% left, 30% right, 8% top, and 25% bottom. Since Bar Code 1 passes through the centering window, it will be read. Bar Code 2 does not pass through the centering window, so it will not be read.

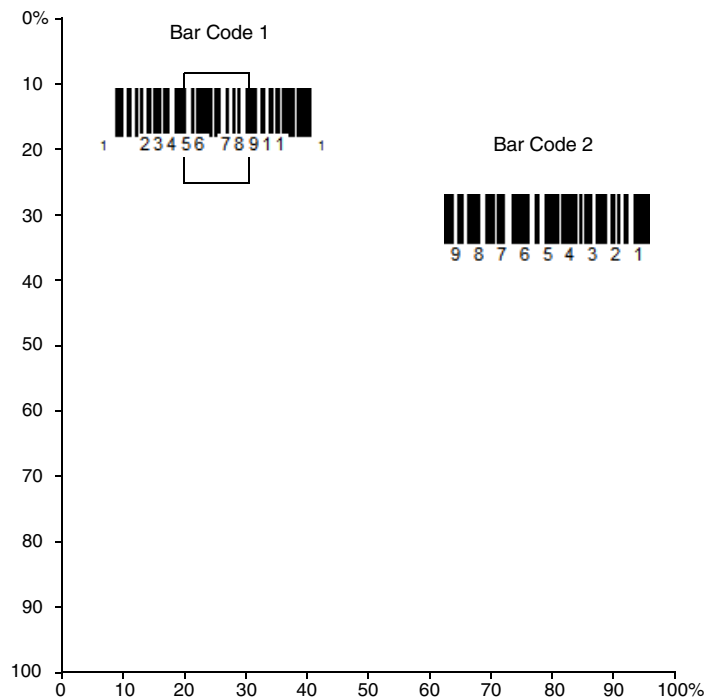

*Note: A bar code needs only to be touched by the centering window in order to be read. It does not need to pass completely through the centering window.*

Scan **Centering On**, then scan one of the following bar codes to change the top, bottom, left, or right of the centering window. Then scan the percent you want to shift the centering window using digits on the inside back cover of this manual. Scan **Save**.  
*Default Centering = 40% for Top and Left, 60% for Bottom and Right.*





## No Read

With No Read turned **On**, the scanner notifies you if a code cannot be read. If using an EZConfig-Scanning Tool Scan Data Window (see page 8-2), an “NR” appears when a code cannot be read. If No Read is turned **Off**, the “NR” will not appear.  
*Default = Off.*



If you want a different notation than “NR,” for example, “Error,” or “Bad Code,” you can edit the output message (see [Data Formatting](#) beginning on page 6-1). The hex code for the No Read symbol is 9C.

---

## Video Reverse

Video Reverse is used to allow the scanner to read bar codes that are inverted. The **Video Reverse Off** bar code below is an example of this type of bar code. Scan **Video Reverse Only** to read *only* inverted bar codes. Scan **Video Reverse and Standard Bar Codes** to read both types of codes.

*Note: After scanning **Video Reverse Only**, menu bar codes cannot be read. You must scan **Video Reverse Off** or **Video Reverse and Standard Bar Codes** in order to read menu bar codes.*

*Note: Images downloaded from the unit are not reversed. This is a setting for decoding only.*



VIDREV1.

**Video Reverse Only**



VIDREV2

**Video Reverse and Standard Bar Codes**



VIDREVO.

**\* Video Reverse Off**

## Working Orientation

Some bar codes are direction-sensitive. For example, KIX codes and OCR can misread when scanned sideways or upside down. Use the working orientation settings if your direction-sensitive codes will not usually be presented upright to the scanner. *Default = Upright.*

Upright:



Upside Down:



Vertical, Top to Bottom:  
(Rotate CW 90°)



Vertical, Bottom to Top:  
(Rotate CCW 90°)







ROTATN0.  
**\* Upright**



ROTATN2.  
**Upside Down**



ROTATN1.  
**Vertical, Bottom to Top**



ROTATN3.  
**Vertical, Top to Bottom**



## Prefix/Suffix Overview

When a bar code is scanned, additional information is sent to the host computer along with the bar code data. This group of bar code data and additional, user-defined data is called a “message string.” The selections in this section are used to build the user-defined data into the message string.

Prefix and Suffix characters are data characters that can be sent before and after scanned data. You can specify if they should be sent with all symbologies, or only with specific symbologies. The following illustration shows the breakdown of a message string:

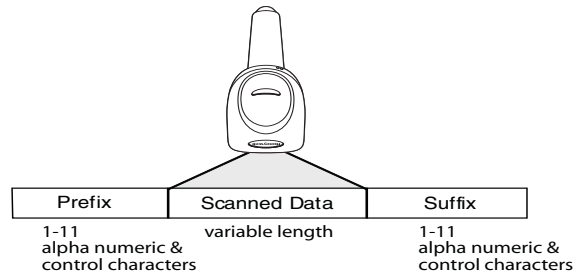

### Points to Keep In Mind

- It is not necessary to build a message string. The selections in this chapter are only used if you wish to alter the default settings. *Default prefix = None. Default suffix = None.*
- A prefix or suffix may be added or cleared from one symbology or all symbologies.
- You can add any prefix or suffix from the [ASCII Conversion Chart \(Code Page 1252\)](#), beginning on page A-3, plus Code I.D. and AIM I.D.
- You can string together several entries for several symbologies at one time.
- Enter prefixes and suffixes in the order in which you want them to appear on the output.
- When setting up for specific symbologies (as opposed to all symbologies), the specific symbology ID value counts as an added prefix or suffix character.
- The maximum size of a prefix or suffix configuration is 200 characters, which includes header information.

### To Add a Prefix or Suffix:

**Step 1.** Scan the **Add Prefix** or **Add Suffix** symbol ([page 5-2](#)).

**Step 2.** Determine the 2 digit Hex value from the Symbology Chart (included in the [Symbology Charts](#), beginning on page A-1) for the symbology to which you want to apply the prefix or suffix. For example, for Code 128, Code ID is “j” and Hex ID is “6A”.

**Step 3.** Scan the 2 hex digits from the [Programming Chart](#) inside the back cover of this manual or scan **9, 9** for all symbologies.

**Step 4.** Determine the hex value from the [ASCII Conversion Chart \(Code Page 1252\)](#), beginning on page A-3, for the prefix or suffix you wish to enter.

*Note: To add the Code I.D., scan **5, C, 8, 0**.*

*To add AIM I.D., scan **5, C, 8, 1**.*

*To add a backslash (\), scan **5, C, 5, C**.*

*To add a backslash (\), you must scan **5C** twice – once to create the leading backslash and then to create the backslash itself.*

**Step 5.** Scan the 2 digit hex value from the [Programming Chart](#) inside the back cover of this manual.

**Step 6.** Repeat Steps 4 and 5 for every prefix or suffix character.

**Step 7.** Scan **Save** to exit and save, or scan **Discard** to exit without saving.

Repeat Steps 1-6 to add a prefix or suffix for another symbology.

---

### **Example: Add a Tab Suffix to All Symbologies**

**Step 1.** Scan **Add Suffix**.

**Step 2.** Scan **9, 9** from the [Programming Chart](#) inside the back cover of this manual to apply this suffix to all symbologies.

**Step 3.** Scan **0, 9** from the [Programming Chart](#) inside the back cover of this manual. This corresponds with the hex value for a horizontal tab, shown in the [ASCII Conversion Chart \(Code Page 1252\)](#), beginning on page A-3.

**Step 4.** Scan **Save**, or scan **Discard** to exit without saving.

### **To Clear One or All Prefixes or Suffixes**

You can clear a single prefix or suffix, or clear all prefixes/suffixes for a symbology. If you have been entering prefixes and suffixes for single symbologies, you can use **Clear One Prefix (Suffix)** to delete a specific character from a symbology. When you **Clear All Prefixes (Suffixes)**, all the prefixes or suffixes for a symbology are deleted.

**Step 1.** Scan the **Clear One Prefix** or **Clear One Suffix** symbol.

**Step 2.** Determine the 2 digit Hex value from the Symbology Chart (included in the [Symbology Charts](#), beginning on page A-1) for the symbology from which you want to clear the prefix or suffix.

**Step 3.** Scan the 2 digit hex value from the [Programming Chart](#) inside the back cover of this manual or scan **9, 9** for all symbologies.

Your change is automatically saved.

### **To Add a Carriage Return Suffix to All Symbologies**

Scan the following bar code if you wish to add a carriage return suffix to all symbologies at once. This action first clears all current suffixes, then programs a carriage return suffix for all symbologies.



VSUF CR.  
Add CR Suffix  
All Symbologies

### **Prefix Selections**



PREBK2.  
Add Prefix



PRECL2.  
Clear One Prefix



PRECA2.  
Clear All Prefixes

### **Suffix Selections**



SUFBK2.  
Add Suffix



## Function Code Transmit

When this selection is enabled and function codes are contained within the scanned data, the scanner transmits the function code to the terminal. Charts of these function codes are provided in "ASCII Conversion Chart (Code Page 1252)" on page A-3 starting on [page A-3](#). When the scanner is in keyboard wedge mode, the scan code is converted to a key code before it is transmitted. *Default = Enable.*



## Intercharacter, Interfunction, and Intermessage Delays

Some terminals drop information (characters) if data comes through too quickly. Intercharacter, interfunction, and intermessage delays slow the transmission of data, increasing data integrity.

### Intercharacter Delay

An intercharacter delay of up to 5000 milliseconds (in 5ms increments) may be placed between the transmission of each character of scanned data. Scan the **Intercharacter Delay** bar code below, then scan the number of 5ms delays, and the **Save** bar code using the [Programming Chart](#) inside the back cover of this manual.

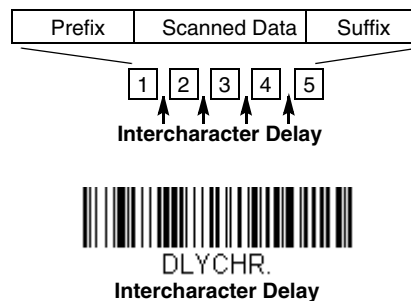

To remove this delay, scan the **Intercharacter Delay** bar code, then set the number of delays to 0. Scan the **Save** bar code using the [Programming Chart](#) inside the back cover of this manual.

*Note: Intercharacter delays are not supported in USB serial emulation.*

### User Specified Intercharacter Delay

An intercharacter delay of up to 5000 milliseconds (in 5ms increments) may be placed after the transmission of a particular character of scanned data. Scan the **Delay Length** bar code below, then scan the number of 5ms delays, and the **Save** bar code using the [Programming Chart](#) inside the back cover of this manual.

Next, scan the **Character to Trigger Delay** bar code, then the 2-digit hex value for a printable character to trigger the delay (see [Lower ASCII Reference Table](#) on page A-4).



To remove this delay, scan the **Delay Length** bar code, and set the number of delays to 0. Scan the **Save** bar code using the [Programming Chart](#) inside the back cover of this manual.

### Interfunction Delay

An interfunction delay of up to 5000 milliseconds (in 5ms increments) may be placed between the transmission of each segment of the message string. Scan the **Interfunction Delay** bar code below, then scan the number of 5ms delays, and the **Save** bar code using the [Programming Chart](#) inside the back cover of this manual.

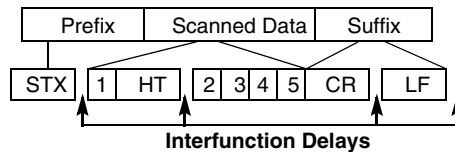

To remove this delay, scan the **Interfunction Delay** bar code, then set the number of delays to 0. Scan the **Save** bar code using the [Programming Chart](#) inside the back cover of this manual.

### Intermessage Delay

An intermessage delay of up to 5000 milliseconds (in 5ms increments) may be placed between each scan transmission. Scan the **Intermessage Delay** bar code below, then scan the number of 5ms delays, and the **Save** bar code using the [Programming Chart](#) inside the back cover of this manual.

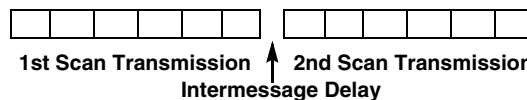

To remove this delay, scan the **Intermessage Delay** bar code, then set the number of delays to 0. Scan the **Save** bar code using the [Programming Chart](#) inside the back cover of this manual.

## Data Formatting

### Data Format Editor Introduction

You may use the Data Format Editor to change the scanner's output. For example, you can use the Data Format Editor to insert characters at certain points in bar code data as it is scanned. The selections in the following pages are used only if you wish to alter the output. *Default Data Format setting = None.*

Normally, when you scan a bar code, it gets outputted automatically; however when you create a format, you must use a "send" command (see [Send Commands](#) on page 6-3) within the format program to output data.

Multiple formats may be programmed into the scanner. They are stacked in the order in which they are entered. However, the following list presents the order in which formats are applied:

1. Specific Terminal ID, Actual Code ID, Actual Length
2. Specific Terminal ID, Actual Code ID, Universal Length
3. Specific Terminal ID, Universal Code ID, Actual Length
4. Specific Terminal ID, Universal Code ID, Universal Length
5. Universal Terminal ID, Actual Code ID, Actual Length
6. Universal Terminal ID, Actual Code ID, Universal Length
7. Universal Terminal ID, Universal Code ID, Actual Length
8. Universal Terminal ID, Universal Code ID, Universal Length

The maximum size of a data format configuration is 2000 bytes, which includes header information.

If you have changed data format settings, and wish to clear all formats and return to the factory defaults, scan the **Default Data Format** code below.



### Add a Data Format

**Step 1.** Scan the **Enter Data Format** symbol ([page 6-2](#)).

**Step 2. Select Primary/Alternate Format**

Determine if this will be your primary data format, or one of 3 alternate formats. This allows you to save a total of 4 different data formats. To program your primary format, scan **0** using the [Programming Chart](#) inside the back cover of this manual. If you are programming an alternate format, scan **1**, **2**, or **3**, depending on which alternate format you are programming. (See "Primary/Alternate Data Formats" on page 6-9 for further information.)

**Step 3. Terminal Type**

Refer to [Terminal ID Table](#) (page 6-3) and locate the Terminal ID number for your PC. Scan three numeric bar codes on the inside back cover to program the scanner for your terminal ID (you must enter 3 digits). For example, scan **0 0 3** for an AT wedge.

*Note: The wildcard for all terminal types is 099.*

**Step 4. Code I.D.**

In the [Symbology Charts](#), beginning on page A-1, find the symbology to which you want to apply the data format. Locate the Hex value for that symbology and scan the 2 digit hex value from the [Programming Chart](#) inside the back cover of this manual.

*Note: If you are creating a data format for Batch Mode Quantity, use 35 for the Code I.D.*

**Step 5. Length**

Specify what length (up to 9999 characters) of data will be acceptable for this symbology. Scan the four digit data length

---

from the [Programming Chart](#) inside the back cover of this manual. (Note: 50 characters is entered as 0050. 9999 is a universal number, indicating all lengths.)

**Step 6. Editor Commands**

Refer to [Data Format Editor Commands](#) (page 6-3). Scan the symbols that represent the command you want to enter.

**Step 7.** Scan **Save** to save your data format, or **Discard** to exit without saving your changes.



DFMBK3.  
**Enter Data Format**



MNUSAV.  
**Save**



MNUABT.  
**Discard**

### ***Other Programming Selections***

**Clear One Data Format**

This deletes one data format for one symbology. If you are clearing the primary format, scan **0** from the [Programming Chart](#) inside the back cover of this manual. If you are clearing an alternate format, scan **1**, **2**, or **3**, depending on the format you are clearing. Scan the Terminal Type and Code I.D. (see [Symbology Charts](#) on page A-1), and the bar code data length for the specific data format that you want to delete. All other formats remain unaffected.

**Clear all Data Formats**

This clears all data formats.

**Save** to exit and save your data format changes.

**Discard** to exit without saving any data format changes.



DFMCL3.  
**Clear One Data Format**



DFMCA3.  
**Clear All Data Formats**



MNUSAV.  
**Save**



MNUABT.  
**Discard**



---

## Terminal ID Table

Terminal	Model(s)	Terminal ID
USB	PC keyboard (HID)	124
	Mac Keyboard	125
	PC Keyboard (Japanese)	134
	Serial (COM driver required)	130
	HID POS	131
	USB SurePOS Handheld	128
	USB SurePOS Tabletop	129
Serial	RS232 TTL	000
	RS232 True	000
Keyboard	PS2 compatibles	003

## Data Format Editor Commands

### Send Commands

#### Send all characters

- F1 Include in the output message all of the characters from the input message, starting from current cursor position, followed by an insert character. *Syntax = F1xx* where xx stands for the insert character's hex value for its ASCII code. Refer to the [ASCII Conversion Chart \(Code Page 1252\)](#), beginning on page A-3 for decimal, hex and character codes.

#### Send a number of characters

- F2 Include in the output message a number of characters followed by an insert character. Start from the current cursor position and continue for "nn" characters or through the last character in the input message, followed by character "xx." *Syntax = F2nxx* where nn stands for the numeric value (00-99) for the number of characters, and xx stands for the insert character's hex value for its ASCII code. Refer to the [ASCII Conversion Chart \(Code Page 1252\)](#), beginning on page A-3 for decimal, hex and character codes.

#### F2 Example: Send a number of characters



Send the first 10 characters from the bar code above, followed by a carriage return. Command string: **F2100D**

F2 is the "Send a number of characters" command

10 is the number of characters to send

0D is the hex value for a CR

The data is output as: **1234567890**

#### F2 and F1 Example: Split characters into 2 lines

Send the first 10 characters from the bar code above, followed by a carriage return, followed by the rest of the characters.

Command string: **F2100DF10D**

F2 is the "Send a number of characters" command

10 is the number of characters to send for the first line

0D is the hex value for a CR

F1 is the "Send all characters" command

0D is the hex value for a CR

---

The data is output as:

**1234567890**  
**ABCDEFGHIJ**  
<CR>

### ***Send all characters up to a particular character***

- F3 Include in the output message all characters from the input message, starting with the character at the current cursor position and continuing to, but not including, the search character “ss,” followed by an insert character. The cursor is moved forward to the “ss” character. *Syntax = F3ssxx* where ss stands for the search character’s hex value for its ASCII code, and xx stands for the insert character’s hex value for its ASCII code. Refer to the [ASCII Conversion Chart \(Code Page 1252\)](#), beginning on page A-3 for decimal, hex and character codes.

**F3 Example: Send all characters up to a particular character**



Using the bar code above, send all characters up to but not including “D,” followed by a carriage return.

Command string: **F3440D**

F3 is the “Send all characters up to a particular character” command

44 is the hex value for a ‘D’

0D is the hex value for a CR

The data is output as:

**1234567890ABC**  
<CR>

### ***Send all but the last characters***

- E9 Include in the output message all but the last “nn” characters, starting from the current cursor position. The cursor is moved forward to one position past the last input message character included. *Syntax = E9nn* where nn stands for the numeric value (00-99) for the number of characters that will not be sent at the end of the message.

### ***Insert a character multiple times***

- F4 Send “xx” character “nn” times in the output message, leaving the cursor in the current position. *Syntax = F4xxnn* where xx stands for the insert character’s hex value for its ASCII code, and nn is the numeric value (00-99) for the number of times it should be sent. Refer to the [ASCII Conversion Chart \(Code Page 1252\)](#), beginning on page A-3 for decimal, hex and character codes.

**E9 and F4 Example: Send all but the last characters, followed by 2 tabs**



Send all characters except for the last 8 from the bar code above, followed by 2 tabs.

Command string: **E908F40902**

E9 is the “Send all but the last characters” command

08 is the number of characters at the end to ignore

F4 is the “Insert a character multiple times” command

09 is the hex value for a horizontal tab

02 is the number of times the tab character is sent

The data is output as: **1234567890AB <tab><tab>**

## ***Move Commands***

### ***Move the cursor forward a number of characters***

- F5 Move the cursor ahead “nn” characters from current cursor position. *Syntax = F5nn* where nn is the numeric value (00-99) for the number of characters the cursor should be moved ahead.

---

**F5 Example: Move the cursor forward and send the data**



Move the cursor forward 3 characters, then send the rest of the bar code data from the bar code above. End with a carriage return.

Command string: **F503F10D**

F5 is the "Move the cursor forward a number of characters" command

03 is the number of characters to move the cursor

F1 is the "Send all characters" command

0D is the hex value for a CR

The data is output as:

**4567890ABCDEFGHIJ**

**<CR>**

***Move the cursor backward a number of characters***

- F6 Move the cursor back "nn" characters from current cursor position. *Syntax = F6nn* where nn is the numeric value (00-99) for the number of characters the cursor should be moved back.

***Move the cursor to the beginning***

- F7 Move the cursor to the first character in the input message. *Syntax = F7.*

**FE and F7 Example: Manipulate bar codes that begin with a 1**



Search for bar codes that begin with a 1. If a bar code matches, move the cursor back to the beginning of the data and send 6 characters followed by a carriage return. Using the bar code above:

Command string: **FE31F7F2060D**

FE is the "Compare characters" command

31 is the hex value for 1

F7 is the "Move the cursor to the beginning" command

F2 is the "Send a number of characters" command

06 is the number of characters to send

0D is the hex value for a CR

The data is output as:

**123456**

**<CR>**

***Move the cursor to the end***

- EA Move the cursor to the last character in the input message. *Syntax = EA.*

**Search Commands**

***Search forward for a character***

- F8 Search the input message forward for "xx" character from the current cursor position, leaving the cursor pointing to the "xx" character. *Syntax = F8xx* where xx stands for the search character's hex value for its ASCII code. Refer to the [ASCII Conversion Chart \(Code Page 1252\)](#), beginning on page A-3 for decimal, hex and character codes.

---

**F8 Example: Send bar code data that starts after a particular character**



Search for the letter "D" in bar codes and send all the data that follows, including the "D." Using the bar code above:

Command string: **F844F10D**

F8 is the "Search forward for a character" command

44 is the hex value for "D"

F1 is the "Send all characters" command

0D is the hex value for a CR

The data is output as:

**DEFGHIJ**

**<CR>**

***Search backward for a character***

- F9 Search the input message backward for the "xx" character from the current cursor position, leaving the cursor pointing to the "xx" character. *Syntax = F9xx* where xx stands for the search character's hex value for its ASCII code. Refer to the [ASCII Conversion Chart \(Code Page 1252\)](#), beginning on page A-3 for decimal, hex and character codes.

***Search forward for a non-matching character***

- E6 Search the input message forward for the first non-"xx" character from the current cursor position, leaving the cursor pointing to the non-"xx" character. *Syntax = E6xx* where xx stands for the search character's hex value for its ASCII code. Refer to the [ASCII Conversion Chart \(Code Page 1252\)](#), beginning on page A-3 for decimal, hex and character codes.

**E6 Example: Remove zeroes at the beginning of bar code data**



This example shows a bar code that has been zero filled. You may want to ignore the zeroes and send all the data that follows. E6 searches forward for the first character that is not zero, then sends all the data after, followed by a carriage return. Using the bar code above:

Command string: **E630F10D**

E6 is the "Search forward for a non-matching character" command

30 is the hex value for 0

F1 is the "Send all characters" command

0D is the hex value for a CR

The data is output as:

**37692**

**<CR>**

***Search backward for a non-matching character***

- E7 Search the input message backward for the first non-"xx" character from the current cursor position, leaving the cursor pointing to the non-"xx" character. *Syntax = E7xx* where xx stands for the search character's hex value for its ASCII code. Refer to the [ASCII Conversion Chart \(Code Page 1252\)](#), beginning on page A-3 for decimal, hex and character codes.

---

## Miscellaneous Commands

### Suppress characters

- FB Suppress all occurrences of up to 15 different characters, starting at the current cursor position, as the cursor is advanced by other commands. When the FC command is encountered, the suppress function is terminated. The cursor is not moved by the FB command.  
Syntax = FBnnxxyy . .zz where nn is a count of the number of suppressed characters in the list, and xxyy .. zz is the list of characters to be suppressed.

**FB Example: Remove spaces in bar code data**



This example shows a bar code that has spaces in the data. You may want to remove the spaces before sending the data. Using the bar code above:

Command string: **FB0120F10D**

FB is the "Suppress characters" command

01 is the number of character types to be suppressed

20 is the hex value for a space

F1 is the "Send all characters" command

0D is the hex value for a CR

The data is output as:

**34567890**

<CR>

### Stop suppressing characters

- FC Disables suppress filter and clear all suppressed characters. *Syntax = FC.*

### Replace characters

- E4 Replaces up to 15 characters in the output message, without moving the cursor. Replacement continues until the E5 command is encountered. *Syntax = E4nnxx<sub>1</sub>xx<sub>2</sub>yy<sub>1</sub>yy<sub>2</sub>...zz<sub>1</sub>zz<sub>2</sub>* where nn is the total count of the number of characters in the list (characters to be replaced plus replacement characters); xx<sub>1</sub> defines characters to be replaced and xx<sub>2</sub> defines replacement characters, continuing through zz<sub>1</sub> and zz<sub>2</sub>.

**E4 Example: Replace zeroes with CRs in bar code data**



If the bar code has characters that the host application does not want included, you can use the E4 command to replace those characters with something else. In this example, you will replace the zeroes in the bar code above with carriage returns.

Command string: **E402300DF10D**

E4 is the "Replace characters" command

02 is the total count of characters to be replaced, plus the replacement characters (0 is replaced by CR, so total characters = 2)

30 is the hex value for 0

0D is the hex value for a CR (the character that will replace the 0)

F1 is the "Send all characters" command

0D is the hex value for a CR

---

The data is output as:

**1234**  
**5678**  
**ABC**  
**<CR>**

### ***Stop replacing characters***

E5 Terminates character replacement. *Syntax = E5.*

### ***Compare characters***

FE Compare the character in the current cursor position to the character “xx.” If characters are equal, move the cursor forward one position. *Syntax = FExx* where xx stands for the comparison character’s hex value for its ASCII code. Refer to the [ASCII Conversion Chart \(Code Page 1252\)](#), beginning on page A-3 for decimal, hex and character codes.

### ***Check for a number***

EC Check to make sure there is an ASCII number at the current cursor position. The format is aborted if the character is not numeric.

#### **EC Example: Only output the data if the bar code begins with a number**

If you want only data from bar codes that begin with a number, you can use EC to check for the number.

Command string: **ECF10D**

EC is the “Check for a number” command

F1 is the “Send all characters” command

0D is the hex value for a CR

If this bar code is read,  the next data format, if there is one, will be used on the data. If there is no other format, the format fails and the raw data is output as **AB1234**.

If this bar code is read,  the data is output as:

**1234AB**  
**<CR>**

### ***Check for non-numeric character***

ED Check to make sure there is a non-numeric ASCII character at the current cursor position. The format is aborted if the character is numeric.

#### **ED Example: Only output the data if the bar code begins with a letter**

If you want only data from bar codes that begin with a letter, you can use ED to check for the letter.

Command string: **EDF10D**

ED is the “Check for a non-numeric character” command

F1 is the “Send all characters” command

0D is the hex value for a CR

If this bar code is read,  the next data format, if there is one, will be used on this data. If there is no other format, the format fails and the raw data is output as **1234AB**.

If this bar code is read,  the data is output as:

**AB1234**  
**<CR>**

---

### ***Insert a delay***

EF Inserts a delay of up to 49,995 milliseconds (in multiples of 5), starting from the current cursor position. Syntax = EFnnnn where nnnn stands for the delay in 5ms increments, up to 9999. This command can only be used with keyboard emulation.

### ***Data Formatter***

When Data Formatter is turned Off, the bar code data is output to the host as read, including prefixes and suffixes.



DFM\_END.  
**Data Formatter Off**

You may wish to require the data to conform to a data format you have created and saved. The following settings can be applied to your data format:

#### **Data Formatter On, Not Required, Keep Prefix/Suffix**

Scanned data is modified according to your data format, and prefixes and suffixes are transmitted.

#### **Data Format Required, Keep Prefix/Suffix**

Scanned data is modified according to your data format, and prefixes and suffixes are transmitted. Any data that does not match your data format requirements generates an error tone and the data in that bar code is not transmitted.

*Default = Data Formatter On, Not Required, Keep Prefix/Suffix.*



DFM\_EN1.  
**\* Data Formatter On,  
Not Required,  
Keep Prefix/Suffix**



DFM\_EN2.  
**Data Format Required,  
Keep Prefix/Suffix**

### ***Primary/Alternate Data Formats***

You can save up to four data formats, and switch between these formats. Your primary data format is saved under **0**. Your other three formats are saved under **1**, **2**, and **3**. To set your device to use one of these formats, scan one of the bar codes below.



ALTFNM0.  
**Primary Data Format**



ALTFNM1.  
**Data Format 1**



ALTFNM2.  
**Data Format 2**



ALTFNM3.  
**Data Format 3**



## Symbologies

This programming section contains the following menu selections. Refer to [Chapter 9](#) for settings and defaults.

- All Symbologies
- Aztec Code
- China Post (Hong Kong 2 of 5)
- Chinese Sensible (Han Xin) Code
- Codabar
- Codablock A
- Codablock F
- Code 11
- Code 128
- Code 32 Pharmaceutical (PARAF)
- Code 39
- Code 93
- Data Matrix
- EAN/JAN-13
- EAN/JAN-8
- GS1 Composite Codes
- GS1 DataBar Expanded
- GS1 DataBar Limited
- GS1 DataBar Omnidirectional
- GS1 Emulation
- GS1-128
- Interleaved 2 of 5
- Korea Post
- Matrix 2 of 5
- MaxiCode
- MicroPDF417
- MSI
- NEC 2 of 5
- Postal Codes - 2D
- Postal Codes - Linear
- PDF417
- GS1 DataBar Omnidirectional
- QR Code
- Straight 2 of 5 IATA (two-bar start/stop)
- Straight 2 of 5 Industrial (three-bar start/stop)
- TCIF Linked Code 39 (TLC39)
- UPC-A
- UPC-A
- UPC-A/EAN-13 with Extended Coupon Code
- UPC-E0
- UPC-E1

### All Symbologies

If you want to decode all the symbologies allowable for your scanner, scan the **All Symbologies On** code. If on the other hand, you want to decode only a particular symbology, scan **All Symbologies Off** followed by the On symbol for that particular symbology.

*Note: Scanner performance may be degraded after scanning All Symbologies On. Only scan All Symbologies On when needed.*



*Note: When All Symbologies On is scanned, 2D Postal Codes are not enabled. 2D Postal Codes must be enabled separately.*

### Message Length Description

You are able to set the valid reading length of some of the bar code symbologies. You may wish to set the same value for minimum and maximum length to force the scanner to read fixed length bar code data. This helps reduce the chances of a misread.

---

**EXAMPLE:** Decode only those bar codes with a count of 9-20 characters.  
Min. length = 09Max. length = 20

**EXAMPLE:** Decode only those bar codes with a count of 15 characters.  
Min. length = 15Max. length = 15

For a value other than the minimum and maximum message length defaults, scan the bar codes included in the explanation of the symbology, then scan the digit value of the message length and **Save** bar codes on the [Programming Chart](#) inside the back cover of this manual. The minimum and maximum lengths and the defaults are included with the respective symbologies.

## Codabar

<Default All Codabar Settings>



### Codabar On/Off



### Codabar Start/Stop Characters

Start/Stop characters identify the leading and trailing ends of the bar code. You may either transmit, or not transmit Start/Stop characters. *Default = Don't Transmit.*



### Codabar Check Character

Codabar check characters are created using different "modulos." You can program the scanner to read only Codabar bar codes with Modulo 16 check characters. *Default = No Check Character.*

**No Check Character** indicates that the scanner reads and transmits bar code data with or without a check character.

When Check Character is set to **Validate and Transmit**, the scanner will only read Codabar bar codes printed with a check character, and will transmit this character at the end of the scanned data.

---

When Check Character is set to **Validate, but Don't Transmit**, the unit will only read Codabar bar codes printed **with** a check character, but will not transmit the check character with the scanned data.



CBRCK20.  
\* No Check Character



CBRCK21.  
Validate Modulo 16, but  
Don't Transmit



CBRCK22.  
Validate Modulo 16  
and Transmit

### **Codabar Concatenation**

Codabar supports symbol concatenation. When you enable concatenation, the scanner looks for a Codabar symbol having a “D” start character, adjacent to a symbol having a “D” stop character. In this case the two messages are concatenated into one with the “D” characters omitted.



A 1 2 3 4 D D 5 6 7 8 A

Select Require to prevent the scanner from decoding a single “D” Codabar symbol without its companion. This selection has no effect on Codabar symbols without Stop/Start D characters.



CBRCCT1.  
On



CBRCCT0.  
\* Off



CBRCCT2.  
Require

### **Codabar Message Length**

Scan the bar codes below to change the message length. Refer to [Message Length Description](#) (page 7-1) for additional information. Minimum and Maximum lengths = 2-60. Minimum Default = 4, Maximum Default = 60.



CBRMIN.  
Minimum Message Length



## Code 39

< Default All Code 39 Settings >



### Code 39 On/Off



### Code 39 Start/Stop Characters

Start/Stop characters identify the leading and trailing ends of the bar code. You may either transmit, or not transmit Start/Stop characters. *Default = Don't Transmit.*



### Code 39 Check Character

**No Check Character** indicates that the scanner reads and transmits bar code data with or without a check character.

When Check Character is set to **Validate, but Don't Transmit**, the unit only reads Code 39 bar codes printed with a check character, but will not transmit the check character with the scanned data.

When Check Character is set to **Validate and Transmit**, the scanner only reads Code 39 bar codes printed with a check character, and will transmit this character at the end of the scanned data. *Default = No Check Character.*





C39CK22.

Validate and Transmit



C39CK21.

Validate, but Don't Transmit

### Code 39 Message Length

Scan the bar codes below to change the message length. Refer to [Message Length Description](#) (page 7-1) for additional information. Minimum and Maximum lengths = 0-48. Minimum Default = 0, Maximum Default = 48.



C39MIN.

Minimum Message Length



C39MAX.

Maximum Message Length

### Code 39 Append

This function allows the scanner to append the data from several Code 39 bar codes together before transmitting them to the host computer. When the scanner encounters a Code 39 bar code with the append trigger character(s), it buffers Code 39 bar codes until it reads a Code 39 bar code that does not have the append trigger. The data is then transmitted in the order in which the bar codes were read (FIFO). *Default = Off.*



C39APP1.

On



C39APP0.

\* Off

### Code 32 Pharmaceutical (PARAF)

Code 32 Pharmaceutical is a form of the Code 39 symbology used by Italian pharmacies. This symbology is also known as PARAF.



C39B321.

On



C39B320.

\* Off

## Full ASCII

If Full ASCII Code 39 decoding is enabled, certain character pairs within the bar code symbol will be interpreted as a single character. For example: \$V will be decoded as the ASCII character SYN, and /C will be decoded as the ASCII character #. *Default = Off.*

NUL %U	DLE \$P	SP SPACE	0 0	@ %V	P P	' %W	p +P
SOH \$A	DC1 \$Q	! /A	1 1	A A	Q Q	a +A	q +Q
STX \$B	DC2 \$R	" /B	2 2	B B	R R	b +B	r +R
ETX \$C	DC3 \$S	# /C	3 3	C C	S S	c +C	s +S
EOT \$D	DC4 \$T	\$ /D	4 4	D D	T T	d +D	t +T
ENQ \$E	NAK \$U	% /E	5 5	E E	U U	e +E	u +U
ACK \$F	SYN \$V	& /F	6 6	F F	V V	f +F	v +V
BEL \$G	ETB \$W	' /G	7 7	G G	W W	g +G	w +W
BS \$H	CAN \$X	( /H	8 8	H H	X X	h +H	x +X
HT \$I	EM \$Y	) /I	9 9	I I	Y Y	i +I	y +Y
LF \$J	SUB \$Z	* /J	: /Z	J J	Z Z	j +J	z +Z
VT \$K	ESC %A	+ /K	; %F	K K	[ %K	k +K	{ %P
FF \$L	FS %B	, /L	< %G	L L	\ %L	l +L	%Q
CR \$M	GS %C	- -	= %H	M M	] %M	m +M	} %R
SO \$N	RS %D	. .	> %I	N N	^ %N	n +N	~ %S
SI \$O	US %E	/ /O	? %J	O O	_ %O	o +O	DEL %T

Character pairs /M and /N decode as a minus sign and period respectively.

Character pairs /P through /Y decode as 0 through 9.



C39ASC1.  
Full ASCII On



C39ASC0.  
\* Full ASCII Off

## Code 39 Code Page

Code pages define the mapping of character codes to characters. If the data received does not display with the proper characters, it may be because the bar code being scanned was created using a code page that is different from the one the host program is expecting. If this is the case, scan the bar code below, select the code page with which the bar codes were created (see [ISO 2022/ISO 646 Character Replacements](#) on page A-7), and scan the value and the **Save** bar code from the [Programming Chart](#) on the inside the back cover of this manual. The data characters should then appear properly.



C39DCP.  
Code 39 Code Page

---

## Interleaved 2 of 5

< Default All Interleaved 2 of 5 Settings >



### Interleaved 2 of 5 On/Off



### Check Digit

**No Check Digit** indicates that the scanner reads and transmits bar code data with or without a check digit.

When Check Digit is set to **Validate, but Don't Transmit**, the unit only reads Interleaved 2 of 5 bar codes printed with a check digit, but will not transmit the check digit with the scanned data.

When Check Digit is set to **Validate and Transmit**, the scanner only reads Interleaved 2 of 5 bar codes printed with a check digit, and will transmit this digit at the end of the scanned data. *Default = No Check Digit.*



### Interleaved 2 of 5 Message Length

Scan the bar codes below to change the message length. Refer to [Message Length Description](#) (page 7-1) for additional information. Minimum and Maximum lengths = 2-80. Minimum Default = 4, Maximum Default = 80.





## NEC 2 of 5

< Default All NEC 2 of 5 Settings >



## NEC 2 of 5 On/Off



## Check Digit

**No Check Digit** indicates that the scanner reads and transmits bar code data with or without a check digit.

When Check Digit is set to **Validate, but Don't Transmit**, the unit only reads NEC 2 of 5 bar codes printed with a check digit, but will not transmit the check digit with the scanned data.

When Check Digit is set to **Validate and Transmit**, the scanner only reads NEC 2 of 5 bar codes printed with a check digit, and will transmit this digit at the end of the scanned data. *Default = No Check Digit.*





---

## NEC 2 of 5 Message Length

Scan the bar codes below to change the message length. Refer to [Message Length Description](#) (page 7-1) for additional information. Minimum and Maximum lengths = 2-80. Minimum Default = 4, Maximum Default = 80.



N25MIN.

Minimum Message Length



N25MAX.

Maximum Message Length

## Code 93

< Default All Code 93 Settings >



C93DFT.

### Code 93 On/Off



C93ENA1.

\* On



C93ENA0.

Off

### Code 93 Message Length

Scan the bar codes below to change the message length. Refer to [Message Length Description](#) (page 7-1) for additional information. Minimum and Maximum lengths = 0-80. Minimum Default = 0, Maximum Default = 80.



C93MIN.

Minimum Message Length



C93MAX.

Maximum Message Length

---

## Code 93 Append

This function allows the scanner to append the data from several Code 93 bar codes together before transmitting them to the host computer. When this function is enabled, the scanner stores those Code 93 bar codes that start with a space (excluding the start and stop symbols), and does not immediately transmit the data. The scanner stores the data in the order in which the bar codes are read, deleting the first space from each. The scanner transmits the appended data when it reads a Code 93 bar code that starts with a character other than a space. *Default = Off.*



C93APP1.

On



C93APP0.

\* Off

## Code 93 Code Page

Code pages define the mapping of character codes to characters. If the data received does not display with the proper characters, it may be because the bar code being scanned was created using a code page that is different from the one the host program is expecting. If this is the case, scan the bar code below, select the code page with which the bar codes were created (see [ISO 2022/ISO 646 Character Replacements](#) on page A-7), and scan the value and the **Save** bar code from the [Programming Chart](#) on the inside the back cover of this manual. The data characters should then appear properly.



C93DCP.

Code 93 Code Page

---

## ***Straight 2 of 5 Industrial (three-bar start/stop)***

*<Default All Straight 2 of 5 Industrial Settings>*



R25DFT.

## ***Straight 2 of 5 Industrial On/Off***



R25ENA1.

**On**



R25ENA0.

**\* Off**

## ***Straight 2 of 5 Industrial Message Length***

Scan the bar codes below to change the message length. Refer to [Message Length Description](#) (page 7-1) for additional information. Minimum and Maximum lengths = 1-48. Minimum Default = 4, Maximum Default = 48.



R25MIN.

**Minimum Message Length**



R25MAX.

**Maximum Message Length**

---

## **Straight 2 of 5 IATA (two-bar start/stop)**

<Default All Straight 2 of 5 IATA Settings>



A25DFT.

### **Straight 2 of 5 IATA On/Off**



A25ENA1.

On



A25ENA0.

\* Off

### **Straight 2 of 5 IATA Message Length**

Scan the bar codes below to change the message length. Refer to [Message Length Description](#) (page 7-1) for additional information. Minimum and Maximum lengths = 1-48. Minimum Default = 4, Maximum Default = 48.



A25MIN.

Minimum Message Length



A25MAX.

Maximum Message Length

---

## Matrix 2 of 5

<Default All Matrix 2 of 5 Settings>



X25DFT.

### Matrix 2 of 5 On/Off



X25ENA1.

On



X25ENA0.

\* Off

### Matrix 2 of 5 Message Length

Scan the bar codes below to change the message length. Refer to [Message Length Description](#) (page 7-1) for additional information. Minimum and Maximum lengths = 1-80. Minimum Default = 4, Maximum Default = 80.



X25MIN.

Minimum Message Length



X25MAX.

Maximum Message Length

---

## Code 11

<Default All Code 11 Settings>



### Code 11 On/Off



### Check Digits Required

This option sets whether 1 or 2 check digits are required with Code 11 bar codes. *Default = Two Check Digits.*



### Code 11 Message Length

Scan the bar codes below to change the message length. Refer to [Message Length Description](#) (page 7-1) for additional information. Minimum and Maximum lengths = 1-80. Minimum Default = 4, Maximum Default = 80.



---

## Code 128

<Default All Code 128 Settings>



### Code 128 On/Off



### ISBT 128 Concatenation

In 1994 the International Society of Blood Transfusion (ISBT) ratified a standard for communicating critical blood information in a uniform manner. The use of ISBT formats requires a paid license. The ISBT 128 Application Specification describes 1) the critical data elements for labeling blood products, 2) the current recommendation to use Code 128 due to its high degree of security and its space-efficient design, 3) a variation of Code 128 that supports concatenation of neighboring symbols, and 4) the standard layout for bar codes on a blood product label. Use the bar codes below to turn concatenation on or off. *Default =Off.*



### Code 128 Message Length

Scan the bar codes below to change the message length. Refer to [Message Length Description](#) (page 7-1) for additional information. Minimum and Maximum lengths = 0-80. Minimum Default = 0, Maximum Default = 80.



---

## Code 128 Append

This function allows the scanner to append the data from several Code 128 bar codes together before transmitting them to the host computer. When the scanner encounters a Code 128 bar code with the append trigger character(s), it buffers Code 128 bar codes until it reads a Code 128 bar code that does not have the append trigger. The data is then transmitted in the order in which the bar codes were read (FIFO). *Default = On.*



128APP1.

\* On



128APP0.

Off

## Code 128 Code Page

Code pages define the mapping of character codes to characters. If the data received does not display with the proper characters, it may be because the bar code being scanned was created using a code page that is different from the one the host program is expecting. If this is the case, scan the bar code below, select the code page with which the bar codes were created (see [ISO 2022/ISO 646 Character Replacements](#) on page A-7), and scan the value and the **Save** bar code from the [Programming Chart](#) on the inside the back cover of this manual. The data characters should then appear properly.



128DCP.

Code 128 Code Page



---

## GS1-128

<Default All GS1-128 Settings>



### GS1-128 On/Off



### GS1-128 Message Length

Scan the bar codes below to change the message length. Refer to [Message Length Description](#) (page 7-1) for additional information. Minimum and Maximum lengths = 1-80. Minimum Default = 1, Maximum Default = 80.



## UPC-A

<Default All UPC-A Settings>



### UPC-A On/Off



Note: To convert UPC-A bar codes to EAN-13, see [Convert UPC-A to EAN-13](#) on page 7-23.

---

### **UPC-A Check Digit**

This selection allows you to specify whether the check digit should be transmitted at the end of the scanned data or not.  
*Default = On.*



### **UPC-A Number System**

The numeric system digit of a U.P.C. symbol is normally transmitted at the beginning of the scanned data, but the unit can be programmed so it will not transmit it. *Default = On.*



### **UPC-A Addenda**

This selection adds 2 or 5 digits to the end of all scanned UPC-A data.  
*Default = Off for both 2 Digit and 5 Digit Addenda.*



---

### UPC-A Addenda Required

When **Required** is scanned, the scanner will only read UPC-A bar codes that have addenda. You must then turn on a 2 or 5 digit addenda listed on [page 7-18](#). *Default = Not Required.*



UPAARQ1.  
**Required**



UPAARQ0.  
**\* Not Required**

### UPC-A Addenda Separator

When this feature is on, there is a space between the data from the bar code and the data from the addenda. When turned off, there is no space. *Default = On.*



UPAADS1.  
**\* On**



UPAADS0.  
**Off**

### UPC-A/EAN-13 with Extended Coupon Code

Use the following codes to enable or disable UPC-A and EAN-13 with Extended Coupon Code. When left on the default setting (**Off**), the scanner treats Coupon Codes and Extended Coupon Codes as single bar codes.

If you scan the **Allow Concatenation** code, when the scanner sees the coupon code and the extended coupon code in a single scan, it transmits both as one symbology. Otherwise, it transmits the first coupon code it reads.

If you scan the **Require Concatenation** code, the scanner must see and read the coupon code and extended coupon code in a single read to transmit the data. No data is output unless both codes are read. *Default = Off.*



CPNENA0.  
**\* Off**



CPNENA1.  
**Allow Concatenation**



CPNENA2.  
**Require Concatenation**

---

## Coupon GS1 DataBar Output

If you scan coupons that have both UPC and GS1 DataBar codes, you may wish to scan and output only the data from the GS1 DataBar code. Scan the **GS1 Output On** code below to scan and output only the GS1 DataBar code data. *Default = GS1 Output Off.*



## UPC-E0

<Default All UPC-E Settings>



### UPC-E0 On/Off

Most U.P.C. bar codes lead with the 0 number system. To read these codes, use the **UPC-E0 On** selection. If you need to read codes that lead with the 1 number system, use [UPC-E1](#) (page 7-22). *Default = On.*



### UPC-E0 Expand

UPC-E Expand expands the UPC-E code to the 12 digit, UPC-A format. *Default = Off.*



---

### **UPC-E0 Addenda Required**

When **Required** is scanned, the scanner will only read UPC-E bar codes that have addenda. *Default = Not Required.*



UPEARQ1.

**Required**



UPEARQ0.

**\* Not Required**

### **UPC-E0 Addenda Separator**

When this feature is **On**, there is a space between the data from the bar code and the data from the addenda. When turned **Off**, there is no space. *Default = On.*



UPEADS1.

**\* On**



UPEADS0.

**Off**

### **UPC-E0 Check Digit**

Check Digit specifies whether the check digit should be transmitted at the end of the scanned data or not. *Default = On.*



UPECKX1.

**\* On**



UPECKX0.

**Off**

### **UPC-E0 Leading Zero**

This feature allows the transmission of a leading zero (0) at the beginning of scanned data. To prevent transmission, scan **Off**. *Default = On.*



UPENSX1.

**\* On**



UPENSX0.

**Off**

---

## UPC-E0 Addenda

This selection adds 2 or 5 digits to the end of all scanned UPC-E data. *Default = Off for both 2 Digit and 5 Digit Addenda.*



UPEAD21.

**2 Digit Addenda On**



UPEAD20.

**\* 2 Digit Addenda Off**



UPEAD51.

**5 Digit Addenda On**



UPEAD50.

**\* 5 Digit Addenda Off**

## UPC-E1

Most U.P.C. bar codes lead with the 0 number system. For these codes, use [UPC-E0](#) (page 7-20). If you need to read codes that lead with the 1 number system, use the **UPC-E1 On** selection. *Default = Off.*



UPEEN11.

**UPC-E1 On**



UPEEN10.

**\* UPC-E1 Off**

---

## EAN/JAN-13

<Default All EAN/JAN Settings>



### EAN/JAN-13 On/Off



### Convert UPC-A to EAN-13

When **UPC-A Converted to EAN-13** is selected, UPC-A bar codes are converted to 13 digit EAN-13 codes by adding a zero to the front. When **Do not Convert UPC-A** is selected, UPC-A codes are read as UPC-A.



### EAN/JAN-13 Check Digit

This selection allows you to specify whether the check digit should be transmitted at the end of the scanned data or not.  
*Default = On.*



---

## ***EAN/JAN-13 Addenda***

This selection adds 2 or 5 digits to the end of all scanned EAN/JAN-13 data. *Default = Off for both 2 Digit and 5 Digit Addenda.*



E13AD21.  
2 Digit Addenda On



E13AD20.  
\* 2 Digit Addenda Off



E13AD51.  
5 Digit Addenda On



E13AD50.  
\* 5 Digit Addenda Off

## ***EAN/JAN-13 Addenda Required***

When **Required** is scanned, the scanner will only read EAN/JAN-13 bar codes that have addenda. *Default = Not Required.*



E13ARQ1.  
Required



E13ARQ0.  
\* Not Required

## ***EAN/JAN-13 Addenda Separator***

When this feature is **On**, there is a space between the data from the bar code and the data from the addenda. When turned **Off**, there is no space. *Default = On.*



E13ADS1.  
\* On



E13ADS0.  
Off

*Note: If you want to enable or disable EAN13 with Extended Coupon Code, refer to [UPC-A/EAN-13 with Extended Coupon Code](#) (page 7-19).*



---

## ISBN Translate

When **On** is scanned, EAN-13 Bookland symbols are translated into their equivalent ISBN number format. *Default = Off.*



E13ISB1.  
On



E13ISB0.  
\* Off

## EAN/JAN-8

<Default All EAN/JAN-8 Settings>



EA8DFT.

### EAN/JAN-8 On/Off



EA8ENA1.  
\* On



EA8ENA0.  
Off

### EAN/JAN-8 Check Digit

This selection allows you to specify whether the check digit should be transmitted at the end of the scanned data or not.  
*Default = On.*



EA8CKX1.  
\* On



EA8CKX0.  
Off

---

### ***EAN/JAN-8 Addenda***

This selection adds 2 or 5 digits to the end of all scanned EAN/JAN-8 data. *Default = Off for both 2 Digit and 5 Digit Addenda.*



### ***EAN/JAN-8 Addenda Required***

When **Required** is scanned, the scanner will only read EAN/JAN-8 bar codes that have addenda. *Default = Not Required.*



### ***EAN/JAN-8 Addenda Separator***

When this feature is **On**, there is a space between the data from the bar code and the data from the addenda. When turned **Off**, there is no space. *Default = On.*



---

## MSI

<Default All MSI Settings>



### MSI On/Off



### MSI Check Character

Different types of check characters are used with MSI bar codes. You can program the scanner to read MSI bar codes with Type 10 check characters. *Default = Validate Type 10, but Don't Transmit.*

When Check Character is set to **Validate Type 10/11 and Transmit**, the scanner will only read MSI bar codes printed with the specified type check character(s), and will transmit the character(s) at the end of the scanned data.

When Check Character is set to **Validate Type 10/11, but Don't Transmit**, the unit will only read MSI bar codes printed with the specified type check character(s), but will not transmit the check character(s) with the scanned data.



\* **Validate Type 10, but Don't Transmit**



**Validate Type 10 and Transmit**



**Validate 2 Type 10 Characters, but Don't Transmit**



**Validate 2 Type 10 Characters and Transmit**



**Validate Type 11 then Type 10 Character, but Don't Transmit**



MSCHK5.  
Validate Type 11 then  
Type 10 Character and Transmit



MSCHK6.  
Disable MSI Check Characters

### ***MSI Message Length***

Scan the bar codes below to change the message length. Refer to [Message Length Description](#) (page 7-1) for additional information. Minimum and Maximum lengths = 4-48. Minimum Default = 4, Maximum Default = 48.



MSIMIN.  
Minimum Message Length



MSIMAX.  
Maximum Message Length

---

## **GS1 DataBar Omnidirectional**

*< Default All GS1 DataBar Omnidirectional Settings >*



### **GS1 DataBar Omnidirectional On/Off**



## **GS1 DataBar Limited**

*< Default All GS1 DataBar Limited Settings >*



### **GS1 DataBar Limited On/Off**



---

## GS1 DataBar Expanded

< Default All GS1 DataBar Expanded Settings >



### GS1 DataBar Expanded On/Off



### GS1 DataBar Expanded Message Length

Scan the bar codes below to change the message length. Refer to [Message Length Description](#) (page 7-1) for additional information. Minimum and Maximum lengths = 4-74. Minimum Default = 4, Maximum Default = 74.



## Codablock A

<Default All Codablock A Settings>



### Codablock A On/Off



---

### **Codablock A Message Length**

Scan the bar codes below to change the message length. Refer to [Message Length Description](#) (page 7-1) for additional information. Minimum and Maximum lengths = 1-600. Minimum Default = 1, Maximum Default = 600.



CBAMIN.

**Minimum Message Length**



CBAMAX.

**Maximum Message Length**

### **Codablock F**

<Default All Codablock F Settings>



CBFDF.

### **Codablock F On/Off**



CBFENA1.

**On**



CBFENA0.

**\* Off**

### **Codablock F Message Length**

Scan the bar codes below to change the message length. Refer to [Message Length Description](#) (page 7-1) for additional information. Minimum and Maximum lengths = 1-2048. Minimum Default = 1, Maximum Default = 2048.



CBFMIN.

**Minimum Message Length**



CBFMAX.

**Maximum Message Length**

---

## PDF417

< Default All PDF417 Settings >



### PDF417 On/Off



### PDF417 Message Length

Scan the bar codes below to change the message length. Refer to [Message Length Description](#) (page 7-1) for additional information. Minimum and Maximum lengths = 1-2750. Minimum Default = 1, Maximum Default = 2750.



### MacroPDF417

MacroPDF417 is an implementation of PDF417 capable of encoding very large amounts of data into multiple PDF417 bar codes. When this selection is enabled, these multiple bar codes are assembled into a single data string. *Default = On.*





---

## MicroPDF417

< Default All MicroPDF417 Settings >



### MicroPDF417 On/Off



### MicroPDF417 Message Length

Scan the bar codes below to change the message length. Refer to [Message Length Description](#) (page 7-1) for additional information. Minimum and Maximum lengths = 1-366. Minimum Default = 1, Maximum Default = 366.



## GS1 Composite Codes

Linear codes are combined with a unique 2D composite component to form a new class called GS1 Composite symbology. GS1 Composite symbologies allow for the co-existence of symbologies already in use. *Default = Off.*



---

## UPC/EAN Version

Scan the **UPC/EAN Version On** bar code to decode GS1 Composite symbols that have a U.P.C. or an EAN linear component. (This does not affect GS1 Composite symbols with a GS1-128 or GS1 linear component.) *Default = UPC/EAN Version Off.*



*Note: If you scan coupons that have both UPC and GS1 DataBar codes, you may wish to scan and output only the data from the GS1 DataBar code. See [Coupon GS1 DataBar Output](#) (page 7-20) for further information.*

## GS1 Composite Code Message Length

Scan the bar codes below to change the message length. Refer to [Message Length Description](#) (page 7-1) for additional information. Minimum and Maximum lengths = 1-2435. Minimum Default = 1, Maximum Default = 2435.



## GS1 Emulation

The scanner can automatically format the output from any GS1 data carrier to emulate what would be encoded in an equivalent GS1-128 or GS1 DataBar symbol. GS1 data carriers include UPC-A and UPC-E, EAN-13 and EAN-8, ITF-14, GS1-128, and GS1-128 DataBar and GS1 Composites. (Any application that accepts GS1 data can be simplified since it only needs to recognize one data carrier type.)

If **GS1-128 Emulation** is scanned, all retail codes (U.P.C., UPC-E, EAN8, EAN13) are expanded out to 16 digits. If the AIM ID is enabled, the value will be the GS1-128 AIM ID, ]C1 (see [Symbology Charts](#) on page A-1).

If **GS1 DataBar Emulation** is scanned, all retail codes (U.P.C., UPC-E, EAN8, EAN13) are expanded out to 16 digits. If the AIM ID is enabled, the value will be the GS1-DataBar AIM ID, ]em (see [Symbology Charts](#) on page A-1).

If **GS1 Code Expansion Off** is scanned, retail code expansion is disabled, and UPC-E expansion is controlled by the [UPC-E0 Expand](#) (page 7-20) setting. If the AIM ID is enabled, the value will be the GS1-128 AIM ID, ]C1 (see [Symbology Charts](#) on page A-1).

If **EAN8 to EAN13 Conversion** is scanned, all EAN8 bar codes are converted to EAN13 format.

*Default = GS1 Emulation Off.*





### ***TCIF Linked Code 39 (TLC39)***

This code is a composite code since it has a Code 39 linear component and a MicroPDF417 stacked code component. All bar code readers are capable of reading the Code 39 linear component. The MicroPDF417 component can only be decoded if **TLC39 On** is selected. The linear component may be decoded as Code 39 even if TLC39 is off. *Default = Off.*



### ***QR Code***

< *Default All QR Code Settings* >



#### ***QR Code On/Off***

This selection applies to both QR Code and Micro QR Code.



---

## QR Code Message Length

Scan the bar codes below to change the message length. Refer to [Message Length Description](#) (page 7-1) for additional information. Minimum and Maximum lengths = 1-7089. Minimum Default = 1, Maximum Default = 7089.



QRCMIN.

Minimum Message Length



QRCMAX.

Maximum Message Length

## QR Code Append

This function allows the scanner to append the data from several QR Code bar codes together before transmitting them to the host computer. When the scanner encounters an QR Code bar code with the append trigger character(s), it buffers the number of QR Code bar codes determined by information encoded in those bar codes. Once the proper number of codes is reached, the data is output in the order specified in the bar codes. *Default = On.*



QRCAPP1.

\* On



QRCAPP0.

Off

## QR Code Page

QR Code pages define the mapping of character codes to characters. If the data received does not display with the proper characters, it may be because the bar code being scanned was created using a code page that is different from the one the host program is expecting. If this is the case, scan the bar code below, select the code page with which the bar codes were created (see [ISO 2022/ISO 646 Character Replacements](#) on page A-7), and scan the value and the **Save** bar code from the [Programming Chart](#) on the inside the back cover of this manual. The data characters should then appear properly.



QRCDP.

QR Code Page

---

## Data Matrix

< Default All Data Matrix Settings >



### Data Matrix On/Off



### Data Matrix Message Length

Scan the bar codes below to change the message length. Refer to [Message Length Description](#) (page 7-1) for additional information. Minimum and Maximum lengths = 1-3116. Minimum Default = 1, Maximum Default = 3116.



### Data Matrix Append

This function allows the scanner to append the data from several Data Matrix bar codes together before transmitting them to the host computer. When the scanner encounters an Data Matrix bar code with the append trigger character(s), it buffers the number of Data Matrix bar codes determined by information encoded in those bar codes. Once the proper number of codes is reached, the data is output in the order specified in the bar codes. *Default = On.*



### Data Matrix Code Page

Data Matrix Code pages define the mapping of character codes to characters. If the data received does not display with the proper characters, it may be because the bar code being scanned was created using a code page that is different from the one the host program is expecting. If this is the case, scan the bar code below, select the code page with which the bar

---

codes were created (see [ISO 2022/ISO 646 Character Replacements](#) on page A-7), and scan the value and the **Save** bar code from the [Programming Chart](#) on the inside the back cover of this manual. The data characters should then appear properly.



## MaxiCode

< Default All MaxiCode Settings >



### MaxiCode On/Off



### MaxiCode Message Length

Scan the bar codes below to change the message length. Refer to [Message Length Description](#) (page 7-1) for additional information. Minimum and Maximum lengths = 1-150. Minimum Default = 1, Maximum Default = 150.



---

## Aztec Code

< Default All Aztec Code Settings >



### Aztec Code On/Off



### Aztec Code Message Length

Scan the bar codes below to change the message length. Refer to [Message Length Description](#) (page 7-1) for additional information. Minimum and Maximum lengths = 1-3832. Minimum Default = 1, Maximum Default = 3832.



### Aztec Append

This function allows the scanner to append the data from several Aztec bar codes together before transmitting them to the host computer. When the scanner encounters an Aztec bar code with the append trigger character(s), it buffers the number of Aztec bar codes determined by information encoded in those bar codes. Once the proper number of codes is reached, the data is output in the order specified in the bar codes. *Default = On.*



### Aztec Code Page

Aztec Code pages define the mapping of character codes to characters. If the data received does not display with the proper characters, it may be because the bar code being scanned was created using a code page that is different from the one the host program is expecting. If this is the case, scan the bar code below, select the code page with which the bar

---

codes were created (see [ISO 2022/ISO 646 Character Replacements](#) on page A-7), and scan the value and the **Save** bar code from the [Programming Chart](#) on the inside the back cover of this manual. The data characters should then appear properly.



## **Chinese Sensible (Han Xin) Code**

< Default All Han Xin Settings >



### **Han Xin Code On/Off**



### **Han Xin Code Message Length**

Scan the bar codes below to change the message length. Refer to [Message Length Description](#) (page 7-1) for additional information. Minimum and Maximum lengths = 1-7833. Minimum Default = 1, Maximum Default = 7833.





---

## Postal Codes - 2D

The following lists the possible 2D postal codes, and 2D postal code combinations that are allowed. Only one 2D postal code selection can be active at a time. If you scan a second 2D postal code selection, the first selection is overwritten. *Default = 2D Postal Codes Off.*



POSTAL0.

\* 2D Postal Codes Off

### Single 2D Postal Codes:



POSTAL1.

Australian Post On



POSTAL7.

British Post On



POSTAL30.

Canadian Post On



POSTAL10.

Intelligent Mail Bar Code On



POSTAL3.

Japanese Post On



POSTAL4.

KIX Post On



POSTAL5.

Planet Code On

Also see [Planet Code Check Digit](#), page 7-44.



POSTAL9.

Postal-4i On



POSTAL6.  
Postnet On

Also see [Postnet Check Digit](#), page 7-44.



POSTAL11.  
Postnet with B and B' Fields On



POSTAL2.  
InfoMail On

### **Combination 2D Postal Codes:**



POSTAL8.  
InfoMail and British  
Post On



POSTAL20.  
Intelligent Mail Bar Code and  
Postnet with B and B' Fields On



POSTAL14.  
Postnet and  
Postal-4i On



POSTAL16.  
Postnet and  
Intelligent Mail Bar Code On



POSTAL17.  
Postal-4i and  
Intelligent Mail Bar Code On



POSTAL19.  
Postal-4i and  
Postnet with B and B' Fields On



POSTAL12.  
Planet Code and  
Postnet On



POSTAL13.  
Planet Code and  
Postal-4i On



POSTAL21.  
Planet Code,  
Postnet, and  
Postal-4i On



POSTAL23.  
Planet Code,  
Postal-4i, and  
Intelligent Mail Bar Code On



POSTAL25.  
Planet Code,  
Postal-4i, and  
Postnet with B and B' Fields On



POSTAL27.  
Postal-4i,  
Intelligent Mail Bar Code, and  
Postnet with B and B' Fields On



POSTAL18.  
Planet Code and  
Postnet with B and B' Fields On



POSTAL15.  
Planet Code and  
Intelligent Mail Bar Code On



POSTAL22.  
Planet Code,  
Postnet, and  
Intelligent Mail Bar Code On



POSTAL24.  
Postnet,  
Postal-4i, and  
Intelligent Mail Bar Code On



POSTAL26.  
Planet Code,  
Intelligent Mail Bar Code, and  
Postnet with B and B' Fields On



POSTAL28.  
Planet Code,  
Postal-4i,  
Intelligent Mail Bar Code, and  
Postnet On



POSTAL29.  
Planet Code,  
Postal-4i,  
Intelligent Mail Bar Code, and  
Postnet with B and B' Fields On

### ***Planet Code Check Digit***

This selection allows you to specify whether the check digit should be transmitted at the end of Planet Code data. *Default = Don't Transmit.*



PLNCKX1.  
Transmit Check Digit



PLNCKXD.  
\* Don't Transmit Check Digit

### ***Postnet Check Digit***

This selection allows you to specify whether the check digit should be transmitted at the end of Postnet data. *Default = Don't Transmit.*



NETCKX1.  
Transmit Check Digit



NETCKXD.  
\* Don't Transmit Check Digit

### ***Australian Post Interpretation***

This option controls what interpretation is applied to customer fields in Australian 4-State symbols.

**Bar Output** lists the bar patterns in "0123" format.

**Numeric N Table** causes that field to be interpreted as numeric data using the N Table.

**Alphanumeric C Table** causes the field to be interpreted as alphanumeric data using the C Table. Refer to the Australian Post Specification Tables.

---

**Combination C and N Tables** causes the field to be interpreted using either the C or N Tables.



AUSINT0.

\* Bar Output



AUSINT1.

Numeric N Table



AUSINT2.

Alphanumeric C Table



AUSINT3.

Combination C and N Tables

## **Postal Codes - Linear**

The following lists linear postal codes. Any combination of linear postal code selections can be active at a time.

### **China Post (Hong Kong 2 of 5)**

*<Default All China Post (Hong Kong 2 of 5) Settings>*



CPCDFT.

### **China Post (Hong Kong 2 of 5) On/Off**



CPCENA1.

On



CPCENAD.

\* Off

### **China Post (Hong Kong 2 of 5) Message Length**

Scan the bar codes below to change the message length. Refer to [Message Length Description](#) (page 7-1) for additional information. Minimum and Maximum lengths = 2-80. Minimum Default = 4, Maximum Default = 80.



CPCMIN.

Minimum Message Length



## Korea Post

<Default All Korea Post Settings>



## Korea Post



## Korea Post Message Length

Scan the bar codes below to change the message length. Refer to [Message Length Description](#) (page 7-1) for additional information. Minimum and Maximum lengths = 2-80. Minimum Default = 4, Maximum Default = 48.



## Korea Post Check Digit

This selection allows you to specify whether the check digit should be transmitted. *Default = Don't Transmit.*



**To Add a Test Code I.D. Prefix to All Symbologies**

This selection allows you to turn on transmission of a Code I.D. before the decoded symbology. (See the [Symbology Charts](#), beginning on page A-1) for the single character code that identifies each symbology.) This action first clears all current prefixes, then programs a Code I.D. prefix for all symbologies. This is a temporary setting that will be removed when the unit is power cycled.



PRECA2,BK2995C80!

**Add Code I.D. Prefix to  
All Symbologies (Temporary)**

**Show Decoder Revision**

Scan the bar code below to output the decoder revision.



REV\_DR.

**Show Decoder Revision**

**Show Scan Driver Revision**

Scan the bar code below to output the scan driver revision. The scan driver controls image capture.



REV\_SD.

**Show Scan Driver Revision**

**Show Software Revision**

Scan the bar code below to output the current software revision, unit serial number, and other product information for both the scanner and the base.



REVINP.

**Show Revision**

**Show Data Format**

Scan the bar code below to show current data format settings.



DFMBK3?.

**Data Format Settings**

---

## Test Menu

When you scan the Test Menu **On** code, then scan a programming code in this manual, the scanner displays the content of a programming code. The programming function will still occur, but in addition, the content of that programming code is output to the terminal.

*Note: This feature should not be used during normal scanner operation.*



## EZConfig-Scanning Introduction

EZConfig-Scanning provides a wide range of PC-based programming functions that can be performed on a scanner connected to your PC. EZConfig-Scanning allows you to download upgrades to the scanner's firmware, change programmed parameters, and create and print programming bar codes. Using EZConfig-Scanning, you can even save/open the programming parameters for a scanner. This saved file can be e-mailed or, if required, you can create a single bar code that contains all the customized programming parameters and mail or fax that bar code to any location. Users in other locations can scan the bar code to load in the customized programming.

### EZConfig-Scanning Operations

The EZConfig-Scanning software performs the following operations:

#### Scan Data

Scan Data allows you to scan bar codes and display the bar code data in a window. Scan Data lets you send serial commands to the scanner and receive scanner response that can be seen in the Scan Data window. The data displayed in the Scan Data window can either be saved in a file or printed.

#### Configure

Configure displays the programming and configuration data of the scanner. The scanner's programming and configuration data is grouped into different categories. Each category is displayed as a tree item under the "Configure" tree node in the application explorer. When one of these tree nodes is clicked, the right-hand side is loaded with the parameters' form belonging to that particular category. The "Configure" tree option has all the programming and configuration parameters specified for a scanner. You can set or modify these parameters as required. You can later write the modified settings to the scanner, or save them to a dcf file.

### Installing EZConfig-Scanning from the Web

*Note: EZConfig-Scanning requires .NET software. If .NET is not installed on your PC, you will be prompted to install it during the EZConfig-Scanning installation.*

1. Access the Honeywell web site at [www.honeywellaidc.com](http://www.honeywellaidc.com)
2. Click on the **Products** tab. Under **Software**, select **Device Management**.
3. Click on **EZConfig-Device Configuration Software**.
4. Click on the **Software** tab. Select **EZConfig Cloud For Scanning** (online version, must register for access) or **EZConfig for Scanning** (to install on your PC, follow the next steps).
5. To install on your PC, when prompted, select **Save File**, and save the files to the **c:\windows\temp** directory.
6. Once you have finished downloading the file, exit the web site.



- 
- Using Explorer, go to the **c:\windows\temp** file.
  - Double click on the **Setup.exe** file. Follow the screen prompts to install the EZConfig-Scanning program.
  - If you've selected the defaults during installation, you can click on **Start Menu-All Programs-Honeywell-EZConfig-Scanning** and select EZConfig for your browser.

## **Resetting the Factory Defaults**



*This selection erases all your settings and resets the scanner to the original factory defaults. It also disables all plugins.*

If you aren't sure what programming options are in your scanner, or you've changed some options and want to restore the scanner to factory default settings, first scan the **Remove Custom Defaults** bar code, then scan **Activate Defaults**. This resets the scanner to the factory default settings.



DEFOVR.

**Remove Custom Defaults**



DEFAULT.

**Activate Defaults**

*Note: If using a cordless system, scanning the **Activate Defaults** bar code also causes both the scanner and the base or Access Point to perform a reset and become unlinked. The scanner must be placed in its base to re-establish the link before any setup codes are entered. If using an Access Point, the linking bar code must be scanned. See [Cordless System Operation](#) beginning on page 3-1 for additional information.*

The [Menu Commands](#), beginning on page 9-3 list the factory default settings for each of the commands (indicated by an asterisk (\*) on the programming pages).



## Serial Programming Commands

The serial programming commands can be used in place of the programming bar codes. Both the serial commands and the programming bar codes will program the scanner. For complete descriptions and examples of each serial programming command, refer to the corresponding programming bar code in this manual.

The device must be set to an RS232 interface (see [page 2-1](#)). The following commands can be sent via a PC COM port using terminal emulation software.

### Conventions

The following conventions are used for menu and query command descriptions:

*parameter* A label representing the actual value you should send as part of a command.

[*option*] An optional part of a command.

{*Data*} Alternatives in a command.

**bold** Names of menus, menu commands, buttons, dialog boxes, and windows that appear on the screen.

### Menu Command Syntax

Menu commands have the following syntax (spaces have been used for clarity only):

*Prefix* [*:Name:*] *Tag SubTag* {*Data*} [, *SubTag* {*Data*}] [*:* *Tag SubTag* {*Data*}] [...] *Storage*

**Prefix** Three ASCII characters: **SYN M CR** (ASCII 22,77,13).

**:Name:** This command is only used with cordless devices. It is used to specify whether you're communicating with the base or the scanner. To send information to the scanner (with the base connected to host), use **:Voyager\_1452g**: The default factory setting for a Voyager 1452g scanner is **Voyager\_1452** scanner. This setting is changed by using the **BT\_NAM** command, which accepts alphanumeric values. If the name is not known, a wildcard (\*) can be used **:\***.

**Note:** *Since the base stores all work group settings and transfers to them to scanner once they are linked, changes are typically done to the base and not to the scanner.*

**Tag** A 3 character case-insensitive field that identifies the desired menu command group. For example, all RS232 configuration settings are identified with a Tag of **232**.

**SubTag** A 3 character case-insensitive field that identifies the desired menu command within the tag group. For example, the SubTag for the RS232 baud rate is **BAD**.

**Data** The new value for a menu setting, identified by the Tag and SubTag.

**Storage** A single character that specifies the storage table to which the command is applied. An exclamation point (!) performs the command's operation on the device's volatile menu configuration table. A period (.) performs the command's operation on the device's non-volatile menu configuration table. Use the non-volatile table only for semi-permanent changes you want saved through a power cycle.

### Query Commands

Several special characters can be used to query the device about its settings.

- ^** What is the default value for the setting(s).
- ?** What is the device's current value for the setting(s).
- \*** What is the range of possible values for the setting(s). (The device's response uses a dash (-) to indicate a continuous range of values. A pipe (|) separates items in a list of non-continuous values.)

#### **:Name: Field Usage (Optional)**

This command returns the query information from the scanner.

#### **Tag Field Usage**

When a query is used in place of a Tag field, the query applies to the *entire* set of commands available for the particular storage table indicated by the Storage field of the command. In this case, the SubTag and Data fields should not be used because they are ignored by the device.

---

## ***SubTag Field Usage***

When a query is used in place of a SubTag field, the query applies only to the subset of commands available that match the Tag field. In this case, the Data field should not be used because it is ignored by the device.

## ***Data Field Usage***

When a query is used in place of the Data field, the query applies only to the specific command identified by the Tag and SubTag fields.

## ***Concatenation of Multiple Commands***

Multiple commands can be issued within one Prefix/Storage sequence. Only the Tag, SubTag, and Data fields must be repeated for each command in the sequence. If additional commands are to be applied to the same Tag, then the new command sequence is separated with a comma (,) and only the SubTag and Data fields of the additional command are issued. If the additional command requires a different Tag field, the command is separated from previous commands by a semicolon (;).

## ***Responses***

The device responds to serial commands with one of three responses:

**ACK** Indicates a good command which has been processed.

**ENQ** Indicates an invalid Tag or SubTag command.

**NAK** Indicates the command was good, but the Data field entry was out of the allowable range for this Tag and SubTag combination, e.g., an entry for a minimum message length of 100 when the field will only accept 2 characters.

When responding, the device echoes back the command sequence with the status character inserted directly before each of the punctuation marks (the period, exclamation point, comma, or semicolon) in the command.

## ***Examples of Query Commands***

In the following examples, a bracketed notation [ ] depicts a non-displayable response.

**Example:** What is the range of possible values for Codabar Coding Enable?

**Enter:**      **cbrena\*.**

**Response:** **CBRENA0-1[ACK]**

This response indicates that Codabar Coding Enable (CBRENA) has a range of values from 0 to 1 (off and on).

**Example:** What is the default value for Codabar Coding Enable?

**Enter:**      **cbrena^.**

**Response:** **CBRENA1[ACK]**

This response indicates that the default setting for Codabar Coding Enable (CBRENA) is 1, or on.

**Example:** What is the device's current setting for Codabar Coding Enable?

**Enter:**      **cbrena?.**

**Response:** **CBRENA1[ACK]**

This response indicates that the device's Codabar Coding Enable (CBRENA) is set to 1, or on.

**Example:** What are the device's settings for all Codabar selections?

**Enter:**      **cbr?.**

**Response:** **CBRENA1[ACK],  
SSX0[ACK],  
CK20[ACK],  
CCT1[ACK],  
MIN2[ACK],  
MAX60[ACK],  
DFT[ACK].**

This response indicates that the device's Codabar Coding Enable (CBRENA) is set to 1, or on;  
the Start/Stop Character (SSX) is set to 0, or Don't Transmit;  
the Check Character (CK2) is set to 0, or Not Required;  
concatenation (CCT) is set to 1, or Enabled;  
the Minimum Message Length (MIN) is set to 2 characters;  
the Maximum Message Length (MAX) is set to 60 characters;  
and the Default setting (DFT) has no value.

## Trigger Commands

You can activate and deactivate the scanner with serial trigger commands. First, the scanner must be put in Manual Trigger Mode by scanning a Manual Trigger Mode bar code (page 4-5), or by sending a serial menu command for triggering (page 4-5). Once the scanner is in serial trigger mode, the trigger is activated and deactivated by sending the following commands:

Activate: **SYN T CR**

Deactivate: **SYN U CR**

The scanner scans until a bar code has been read, until the deactivate command is sent, or until the serial time-out has been reached (see "Read Time-Out" on page 4-5 for a description, and the serial command on page 9-11).

## Resetting the Custom Defaults

If you want the custom default settings restored to your scanner, scan the **Activate Custom Defaults** bar code below. This resets the scanner to the custom default settings. If there are no custom defaults, it will reset the scanner to the factory default settings. Any settings that have not been specified through the custom defaults will be defaulted to the factory default settings.



DEFAULT.

**Activate Custom Defaults**

*Note: If using a cordless system, scanning this bar code also causes both the scanner and the base or Access Point to perform a reset and become unlinked. The scanner must be placed in its base to re-establish the link. If using an Access Point, the linking bar code must be scanned. See [Cordless System Operation](#) beginning on page 3-1 for additional information.*

The charts on the following pages list the factory default settings for each of the commands (indicated by an asterisk (\*) on the programming pages).

## Menu Commands

Selection	Setting * Indicates default	Serial Command # Indicates a numeric entry	Page
<b>Product Default Settings</b>			
Setting Custom Defaults	Set Custom Defaults	MNUCDP	1-7
	Save Custom Defaults	MNUCDS	1-7
Resetting the Custom Defaults	Activate Custom Defaults	DEFAULT	1-7
<b>Programming the Interface</b>			
Plug and Play Codes	Keyboard Wedge: IBM PC AT and Compatibles with CR suffix	PAP_AT	2-1
	Laptop Direct Connect with CR suffix	PAPLTD	2-1
	RS232 Serial Port	PAP232	2-1
Plug and Play Codes: RS485	IBM Port 5B Interface	PAPP5B	2-2
	IBM Port 9B HHBCR-1 Interface	PAP9B1	2-2
	IBM Port 17 Interface	PAPP17	2-2

<b>Selection</b>	<b>Setting</b> <i>* Indicates default</i>	<b>Serial Command</b> <i># Indicates a numeric entry</i>	<b>Page</b>
	IBM Port 9B HHBCR-2 Interface	PAP9B2	<a href="#">2-2</a>
	RS485 Packet Mode On	RTLPDF1	<a href="#">2-2</a>
	*RS485 Packet Mode Off	RTLPDF0	<a href="#">2-2</a>
	RS485 Packet Length (20-256) *40	RTLMP5	<a href="#">2-3</a>
Plug and Play Codes: IBM SurePos	USB IBM SurePos Handheld	PAPSPH	<a href="#">2-3</a>
	USB IBM SurePos Tabletop	PAPSPT	<a href="#">2-3</a>
Plug and Play Codes: USB	USB Keyboard (PC)	PAP124	<a href="#">2-3</a>
	USB Keyboard (Mac)	PAP125	<a href="#">2-3</a>
	USB Japanese Keyboard (PC)	TRMUSB134	<a href="#">2-3</a>
	USB HID	PAP131	<a href="#">2-4</a>
	USB Serial	TRMUSB130	<a href="#">2-4</a>
	CTS/RTS Emulation On	USBCTS1	<a href="#">2-4</a>
	CTS/RTS Emulation Off*	USBCTS0	<a href="#">2-4</a>
	ACK/NAK Mode On	USBACK1	<a href="#">2-4</a>
	ACK/NAK Mode Off*	USBACK0	<a href="#">2-4</a>
Remote MasterMind for USB	ReM Off	REMIFC0	<a href="#">2-5</a>
	*ReM On	REMIFC1	<a href="#">2-5</a>
Plug and Play Codes	Verifone Ruby Terminal	PAPRBY	<a href="#">2-5</a>
	Gilbarco Terminal	PAPGLB	<a href="#">2-5</a>
	Honeywell Bioptic Aux Port	PAPBIO	<a href="#">2-6</a>
	Datalogic Magellan Bioptic Aux Port	PAPMAG	<a href="#">2-6</a>
	NCR Bioptic Aux Port	PAPNCR	<a href="#">2-6</a>
	Wincor Nixdorf Terminal	PAPWNX	<a href="#">2-6</a>
	Wincor Nixdorf Beetle	PAPBTL	<a href="#">2-7</a>
	Wincor Nixdorf RS232 Mode A	PAPWMA	<a href="#">2-7</a>
Program Keyboard Country	*U.S.A.	KBDCTY0	<a href="#">2-8</a>
	Albania	KBDCTY35	<a href="#">2-8</a>
	Azeri (Cyrillic)	KBDCTY81	<a href="#">2-8</a>
	Azeri (Latin)	KBDCTY80	<a href="#">2-8</a>
	Belarus	KBDCTY82	<a href="#">2-8</a>
	Belgium	KBDCTY1	<a href="#">2-8</a>
	Bosnia	KBDCTY33	<a href="#">2-8</a>
	Brazil	KBDCTY16	<a href="#">2-8</a>
	Brazil (MS)	KBDCTY59	<a href="#">2-8</a>
	Bulgaria (Cyrillic)	KBDCTY52	<a href="#">2-8</a>
	Bulgaria (Latin)	KBDCTY53	<a href="#">2-9</a>
	Canada (French legacy)	KBDCTY54	<a href="#">2-9</a>
	Canada (French)	KBDCTY18	<a href="#">2-9</a>
	Canada (Multilingual)	KBDCTY55	<a href="#">2-9</a>
	Croatia	KBDCTY32	<a href="#">2-9</a>
	Czech	KBDCTY15	<a href="#">2-9</a>
	Czech (Programmers)	KBDCTY40	<a href="#">2-9</a>

Selection	Setting <i>* Indicates default</i>	Serial Command <i># Indicates a numeric entry</i>	Page
	Czech (QWERTY)	KBDCTY39	<a href="#">2-9</a>
	Czech (QWERTZ)	KBDCTY38	<a href="#">2-9</a>
	Denmark	KBDCTY8	<a href="#">2-9</a>
	Dutch (Netherlands)	KBDCTY11	<a href="#">2-9</a>
	Estonia	KBDCTY41	<a href="#">2-10</a>
	Faroese	KBDCTY83	<a href="#">2-10</a>
	Finland	KBDCTY2	<a href="#">2-10</a>
	France	KBDCTY3	<a href="#">2-10</a>
	Gaelic	KBDCTY84	<a href="#">2-10</a>
	Germany	KBDCTY4	<a href="#">2-10</a>
	Greek	KBDCTY17	<a href="#">2-10</a>
	Greek (220 Latin)	KBDCTY64	<a href="#">2-10</a>
	Greek (220)	KBDCTY61	<a href="#">2-10</a>
	Greek (319 Latin)	KBDCTY65	<a href="#">2-10</a>
	Greek (319)	KBDCTY62	<a href="#">2-10</a>
	Greek (Latin)	KBDCTY63	<a href="#">2-11</a>
	Greek (MS)	KBDCTY66	<a href="#">2-11</a>
	Greek (Polytonic)	KBDCTY60	<a href="#">2-11</a>
	Hebrew	KBDCTY12	<a href="#">2-11</a>
	Hungarian (101 key)	KBDCTY50	<a href="#">2-11</a>
	Hungary	KBDCTY19	<a href="#">2-11</a>
	Iceland	KBDCTY75	<a href="#">2-11</a>
	Irish	KBDCTY73	<a href="#">2-11</a>
	Italian (142)	KBDCTY56	<a href="#">2-11</a>
	Italy	KBDCTY5	<a href="#">2-11</a>
	Japan ASCII	KBDCTY28	<a href="#">2-11</a>
	Kazakh	KBDCTY78	<a href="#">2-12</a>
	Kyrgyz (Cyrillic)	KBDCTY79	<a href="#">2-12</a>
	Latin America	KBDCTY14	<a href="#">2-12</a>
	Latvia	KBDCTY42	<a href="#">2-12</a>
	Latvia (QWERTY)	KBDCTY43	<a href="#">2-12</a>
	Lithuania	KBDCTY44	<a href="#">2-12</a>
	Lithuania (IBM)	KBDCTY45	<a href="#">2-12</a>
	Macedonia	KBDCTY34	<a href="#">2-12</a>
	Malta	KBDCTY74	<a href="#">2-12</a>
	Mongolian (Cyrillic)	KBDCTY86	<a href="#">2-12</a>
	Norway	KBDCTY9	<a href="#">2-12</a>
	Poland	KBDCTY20	<a href="#">2-13</a>
	Polish (214)	KBDCTY57	<a href="#">2-13</a>
	Polish (Programmers)	KBDCTY58	<a href="#">2-13</a>
	Portugal	KBDCTY13	<a href="#">2-13</a>
	Romania	KBDCTY25	<a href="#">2-13</a>
	Russia	KBDCTY26	<a href="#">2-13</a>

<b>Selection</b>	<b>Setting</b> <i>* Indicates default</i>	<b>Serial Command</b> <i># Indicates a numeric entry</i>	<b>Page</b>
	Russian (MS)	KBDCTY67	<a href="#">2-13</a>
	Russian (Typewriter)	KBDCTY68	<a href="#">2-13</a>
	SCS	KBDCTY21	<a href="#">2-13</a>
	Serbia (Cyrillic)	KBDCTY37	<a href="#">2-13</a>
	Serbia (Latin)	KBDCTY36	<a href="#">2-13</a>
	Slovakia	KBDCTY22	<a href="#">2-14</a>
	Slovakia (QWERTY)	KBDCTY49	<a href="#">2-14</a>
	Slovakia (QWERTZ)	KBDCTY48	<a href="#">2-14</a>
	Slovenia	KBDCTY31	<a href="#">2-14</a>
	Spain	KBDCTY10	<a href="#">2-14</a>
	Spanish variation	KBDCTY51	<a href="#">2-14</a>
	Sweden	KBDCTY23	<a href="#">2-14</a>
	Switzerland (French)	KBDCTY29	<a href="#">2-14</a>
	Switzerland (German)	KBDCTY6	<a href="#">2-14</a>
	Tatar	KBDCTY85	<a href="#">2-14</a>
	Turkey F	KBDCTY27	<a href="#">2-14</a>
	Turkey Q	KBDCTY24	<a href="#">2-15</a>
	Ukrainian	KBDCTY76	<a href="#">2-15</a>
	United Kingdom	KBDCTY7	<a href="#">2-15</a>
	United States (Dvorak right)	KBDCTY89	<a href="#">2-15</a>
	United States (Dvorak left)	KBDCTY88	<a href="#">2-15</a>
	United States (Dvorak)	KBDCTY87	<a href="#">2-15</a>
	United States (International)	KBDCTY30	<a href="#">2-15</a>
	Uzbek (Cyrillic)	KBDCTY77	<a href="#">2-15</a>
Keyboard Conversion	*Keyboard Conversion Off	KBDCNV0	<a href="#">2-16</a>
	Convert all Characters to Upper Case	KBDCNV1	<a href="#">2-16</a>
	Convert all Characters to Lower Case	KBDCNV1	<a href="#">2-16</a>
Keyboard Style	*Regular	KBDSTY0	<a href="#">2-15</a>
	Caps Lock	KBDSTY1	<a href="#">2-15</a>
	Shift Lock	KBDSTY2	<a href="#">2-16</a>
	Automatic Caps Lock	KBDSTY6	<a href="#">2-16</a>
	Emulate External Keyboard	KBDSTY5	<a href="#">2-16</a>
Control Character Output	*Control Character Output Off	KBDNPE0	<a href="#">2-17</a>
	*Control Character Output On	KBDNPE1	<a href="#">2-17</a>
Keyboard Modifiers	*Control + ASCII Off	KBDCAS0	<a href="#">2-17</a>
	DOS Mode Control + ASCII	KBDCAS1	<a href="#">2-17</a>
	Windows Mode Control + ASCII	KBDCAS2	<a href="#">2-17</a>
	Windows Mode Prefix/Suffix Off	KBDCAS3	<a href="#">2-17</a>
	*Turbo Mode Off	KBDTMD0	<a href="#">2-18</a>



<b>Selection</b>	<b>Setting</b> <i>* Indicates default</i>	<b>Serial Command</b> <i># Indicates a numeric entry</i>	<b>Page</b>
	Turbo Mode On	KBDTMD1	<a href="#">2-18</a>
	*Numeric Keypad Off	KBDNPS0	<a href="#">2-18</a>
	Numeric Keypad On	KBDNPS1	<a href="#">2-18</a>
	*Auto Direct Connect Off	KBDADC0	<a href="#">2-18</a>
	Auto Direct Connect On	KBDADC1	<a href="#">2-18</a>
Baud Rate	300 BPS	232BAD0	<a href="#">2-18</a>
	600 BPS	232BAD1	<a href="#">2-18</a>
	1200 BPS	232BAD2	<a href="#">2-19</a>
	2400 BPS	232BAD3	<a href="#">2-19</a>
	4800 BPS	232BAD4	<a href="#">2-19</a>
	9600 BPS	232BAD5	<a href="#">2-19</a>
	19200 BPS	232BAD6	<a href="#">2-19</a>
	38400 BPS	232BAD7	<a href="#">2-19</a>
	57600 BPS	232BAD8	<a href="#">2-19</a>
	*115200 BPS	232BAD9	<a href="#">2-19</a>
Word Length: Data Bits, Stop Bits, and Parity	7 Data, 1 Stop, Parity Even	232WRD3	<a href="#">2-19</a>
	7 Data, 1 Stop, Parity None	232WRD0	<a href="#">2-20</a>
	7 Data, 1 Stop, Parity Odd	232WRD6	<a href="#">2-20</a>
	7 Data, 2 Stop, Parity Even	232WRD4	<a href="#">2-20</a>
	7 Data, 2 Stop, Parity None	232WRD1	<a href="#">2-20</a>
	7 Data, 2 Stop, Parity Odd	232WRD7	<a href="#">2-20</a>
	8 Data, 1 Stop, Parity Even	232WRD5	<a href="#">2-20</a>
	*8 Data, 1 Stop, Parity None	232WRD2	<a href="#">2-20</a>
	8 Data, 1 Stop, Parity Odd	232WRD8	<a href="#">2-20</a>
RS232 Receiver Time-out	Range 0 - 300 seconds	232LPT###	<a href="#">2-20</a>
RS232 Handshaking	*RTS/CTS Off	232CTS0	<a href="#">2-21</a>
	Flow Control, No Timeout	232CTS1	<a href="#">2-21</a>
	Two-Direction Flow Control	232CTS2	<a href="#">2-21</a>
	Flow Control with Timeout	232CTS3	<a href="#">2-21</a>
	RS232 Timeout	232DEL####	<a href="#">2-21</a>
	*XON/XOFF Off	232XON0	<a href="#">2-21</a>
	XON/XOFF On	232XON1	<a href="#">2-21</a>
	*ACK/NAK Off	232ACK0	<a href="#">2-22</a>
	ACK/NAK On	232ACK1	<a href="#">2-22</a>
Scanner-Bioptic Packet Mode	*Packet Mode Off	232PKT0	<a href="#">2-22</a>
	Packet Mode On	232PKT2	<a href="#">2-22</a>
Scanner-Bioptic ACK/NAK Mode	*Bioptic ACK/NAK Off	232NAK0	<a href="#">2-22</a>
	Bioptic ACK/NAK On	232NAK1	<a href="#">2-22</a>
Scanner-Bioptic ACK/NAK Timeout	ACK/NAK Timeout *5100	232DLK#####	<a href="#">2-23</a>

Selection	Setting * Indicates default	Serial Command # Indicates a numeric entry	Page
<b>Cordless System Operation</b>			
<i>Note: This section applies only to cordless systems. It does not apply to corded scanners.</i>			
Base Power Communication Indicator	*On	.*:BASRED1	3-5
	Off	.*:BASRED0	3-5
Reset Scanner	Reset Scanner	RESET_	3-6
Scanning While in Base Cradle	Scanning in Cradle Off	BT_SIC0	3-6
	*Scanning in Cradle On	BT_SIC1	3-6
	Shut Down Scanner in Cradle	BT_SIC2	3-6
Base Charging Modes	Base Charge Off	BASCHG0	3-7
	*External or Interface Cable Power	BASCHG1	3-7
	External Power Only	BASCHG2	3-7
Paging Mode	*On	BEPPGE1	3-7
	Off	BEPPGE0	3-7
Paging Pitch	Low (*1000 Hz)	BEPPFQ1000	3-7
	Medium (3250 Hz)	BEPPFQ3250	3-8
	High (4200)	BEPPFQ4200	3-8
Beeper Pitch - Base Error	*Razz (250) (min 200Hz)	BASFQ2250	3-8
	Medium (3250)	BASFQ23250	3-8
	High (4200) (max 9000Hz)	BASFQ24200	3-8
Number of Beeps - Base Error	*1	BASERR3	3-8
	Range 1 - 9	BASERR#	3-8
Scanner Report	Scanner Report	RPTSCN	3-8
Scanner Address	Scanner Address	BT_LDA	3-9
Base Address	Base Address	.*:BASLDA	3-9
Scanner Modes	Charge Only Mode	.*:BASLNK0	3-9
	*Charge and Link Mode	.*:BASLNK1	3-9
	Locked Link Mode	BASCON0,DNG1	3-10
	*Open Link Mode	BASCON1,DNG1	3-10
	Unlink Scanner	BT_RMV	3-10
	Override Locked Scanner	BT_RPL1	3-10
Out-of-Range Alarm	Base Alarm Duration (Range 1 - 3000 sec (*0))	BASORD	3-11
	Scanner Alarm Duration (Range 1 - 3000 sec (*0))	BT_ORD	3-11
Alarm Sound Type	Base Alarm Type	BASORW	3-11
	Scanner Alarm Type	BT_ORW	3-11
Scanner Power Time-Out Timer	Timer (0-7200 seconds)	BT_LPT0	3-12
	200 Seconds	BT_LPT200	3-12
	400 Seconds	BT_LPT400	3-12
	900 Seconds	BT_LPT900	3-12
	3600 Seconds	BT_LPT3600	3-12
	7200 Seconds	BT_LPT7200	3-12

<b>Selection</b>	<b>Setting</b> <i>* Indicates default</i>	<b>Serial Command</b> <i># Indicates a numeric entry</i>	<b>Page</b>
Flexible Power Management	*Full Power	BT_TXP100	3-13
	Medium Power	BT_TXP35	3-13
	Medium Low Power	BT_TXP5	3-13
	Low Power	BT_TXP1	3-13
Batch Mode	Automatic Batch Mode	BATENA1	3-13
	*Batch Mode Off	BATENA0	3-13
	Inventory Batch Mode	BATENA2	3-13
	Persistent Batch Mode	BATENA3	3-14
Batch Mode Beep	Off	BATBEP0	3-14
	*On	BATBEP1	3-14
Batch Mode Storage	*Flash Storage	BATNVS1	3-14
	RAM Storage	BATNVS0	3-14
Batch Mode Quantity	*Off	BATQTY0	3-15
	On	BATQTY1	3-15
Quantity Codes	0	BATNUM0	3-15
	*1	BATNUM1	3-16
	2	BATNUM2	3-16
	3	BATNUM3	3-16
	4	BATNUM4	3-16
	5	BATNUM5	3-16
	6	BATNUM6	3-16
	7	BATNUM7	3-16
	8	BATNUM8	3-16
	9	BATNUM9	3-16
Batch Mode Output Order	*FIFO	BATLIF0	3-16
	LIFO	BATLIF1	3-16
Total Records	Total Records	BATNRC	3-17
Delete Last Code	Delete Last Code	BATUND	3-17
Clear All Codes	Clear All Codes	BATCLR	3-17
Transmit Records to Host	Transmit Inventory Records	BAT_TX	3-17
Batch Mode Transmit Delay	*Off	BATDLY0	3-17
	Short (ms)	BATDLY250	3-17
	Medium (ms)	BATDLY500	3-18
	Long (ms)	BATDLY1000	3-18
Multiple Scanner Operation	Multiple Scanner Operation	BASCON2,DNG3	3-18
Scanner Name	Name 1-7	BT_NAM#####	3-18
	Reset	RESET_	3-19
	Scanner Name	BT_NAM	3-19
Application Work Group Selections	*Group 0	GRPSEL0	3-19
	Group 1-6	GRPSEL#	3-19
Resetting the Factory Defaults: All Application Work Groups	Factory Default Settings: All Work Groups	PAPDFT&	3-20

<b>Selection</b>	<b>Setting</b> <i>* Indicates default</i>	<b>Serial Command</b> <i># Indicates a numeric entry</i>	<b>Page</b>
Resetting the Custom Defaults: All Application Work Groups	Custom Default Settings: All Work Groups	PAPDFT	3-21
Bluetooth Connection	Bluetooth HID Keyboard Connect	PAPBTH	3-21
	Bluetooth HID Japanese Keyboard Connect	PAPJKB	3-21
	Bluetooth HID Keyboard Disconnect	PAPSPP	3-23
	Bluetooth Serial Port - PCs/Laptops	BT_TRM0;BT_DNG5	3-23
	BT Connection - PDA/Mobility Systems Device	BT_TRM0;BT_DNG1	3-23
	Bluetooth PIN Code	BT_PIN	3-23
Auto Reconnect Mode	*Auto Reconnect On	BT_ACM1	3-24
	Auto Reconnect Off	BT_ACM0	3-24
Maximum Link Attempts	Maximum Link Attempts	BT_MLA	3-25
Relink Time-Out	Relink Time-Out	BT_RLT	3-25
Host Command Acknowledgment	Host ACK On	HSTACK1	3-27
	*Host ACK Off	HSTACK0	3-27
	Host ACK Timeout (range 0-90) *10	HSTATO	3-27
<b>Input/Output Selections</b>			
Power Up Beeper	Power Up Beeper Off - Scanner	BEPPWR0	4-1
	*Power Up Beeper On - Scanner	BEPPWR1	4-1
Beep on BEL Character	Beep on BEL On	BELBEP1	4-1
	*Beep on BEL Off	BELBEP0	4-1
Trigger Click	On	BEPTRG1	4-2
	*Off	BEPTRG0	4-1
Beep on BEL Character	Beep on BEL On	BELBEP1	4-1
	*Beep on BEL Off	BELBEP0	4-1
Beeper - Good Read	Off	BEPBEP0	4-2
	*On	BEPBEP1	4-2
Beeper Volume - Good Read	Off	BEPLVL0	4-2
	Low	BEPLVL1	4-2
	Medium	BEPLVL2	4-2
	*High	BEPLVL3	4-2
Beeper Pitch - Good Read (Frequency)	Low (1600) (min 400Hz)	BEPFQ11600	4-2
	*Medium (2400)	BEPFQ12400	4-3
	High (4200) (max 9000Hz)	BEPFQ14200	4-3
Beeper Pitch - Error (Frequency)	*Razz (250) (min 200Hz)	BEPFQ2800	4-3
	Medium (3250)	BEPFQ23250	4-3
	High (4200) (max 9000Hz)	BEPFQ24200	4-3
Beeper Duration - Good Read	*Normal Beep	BEPBIP0	4-3
	Short Beep	BEPBIP1	4-3
LED - Good Read	Off	BEPLD0	4-3
	*On	BEPLD1	4-3
Number of Beeps - Error	*1	BEPERR3	4-4
	Range 1 - 9	BEPERR#	4-4

<b>Selection</b>	<b>Setting</b> <i>* Indicates default</i>	<b>Serial Command</b> <i># Indicates a numeric entry</i>	<b>Page</b>
Number of Beeps - Good Read	*1	BEPRPT1	4-4
	Range 1 - 9	BEPRPT#	4-4
Good Read Delay	*No Delay	DLYGRD0	4-4
	Short Delay (500 ms)	DLYGRD500	4-4
	Medium Delay (1000 ms)	DLYGRD1000	4-4
	Long Delay (1500 ms)	DLYGRD1500	4-4
User-Specified Good Read Delay	Range 0 - 30,000 ms	DLYGRD#####	4-4
Manual Trigger Mode	*Manual Trigger - Normal	PAPHHF	4-5
LED Illumination - Manual Trigger	Low	PWRNOL7	4-5
	Medium	PWRNOL15	4-5
	Medium High	PWRNOL50	4-5
	*High	PWRNOL150	4-5
Serial Trigger Mode	Read Time-Out (range 0-300,000) *30,000	TRGSTO#####	4-5
Presentation	Presentation Mode	PAPPST	4-6
Idle Illumination - Presentation Mode	Low	PWRIDL7	4-6
	Medium	PWRIDL15	4-6
	*High	PWRIDL50	4-6
Presentation Sensitivity	Range 0-20 (*1)	TRGPMS##	4-6
Presentation Centering Window	Presentation Centering On	PDCWIN1	4-7
	*Presentation Centering Off	PDCWIN0	4-7
	Left of Presentation Centering Window (*40%)	PDCLFT###	4-8
	Right of Presentation Centering Window (*60%)	PDCRGT###	4-8
	Top of Presentation Centering Window (*40%)	PDCTOP###	4-7
	Bottom of Presentation Centering Window (*60%)	PDCBOT###	4-8
In-Stand Sensor Mode	*Sensor On	TRGSSW1	4-8
	Sensor Off	TRGSSW0	4-8
Poor Quality Codes	Poor Quality 1D Reading On	DECLDI1	4-8
	*Poor Quality 1D Reading Off	DECLDI0	4-8
	Poor Quality PDF Reading On	PDFXPR1	4-9
	*Poor Quality PDF Reading Off	PDFXPR0	4-9
CodeGate	*CodeGate Off Out-of-Stand	AOSCGD0.	4-9
	CodeGate On Out-of-Stand	AOSCGD1.	4-9
Mobile Phone Read Mode	Hand Held Scanning - Mobile Phone	PAPHHC	4-9
Hands Free Time-Out	Range 0 - 300,000 ms	TRGPTO#####	4-10
Reread Delay	Short (500 ms)	DLYRRD500	4-10
	*Medium (750 ms)	DLYRRD750	4-10
	Long (1000 ms)	DLYRRD1000	4-10
	Extra Long (2000 ms)	DLYRRD2000	4-10

<b>Selection</b>	<b>Setting</b> <i>* Indicates default</i>	<b>Serial Command</b> <i># Indicates a numeric entry</i>	<b>Page</b>
2D Reread Delay	*2D Reread Delay Off	DLY2RR0	4-10
	Short (1000ms)	DLY2RR1000	4-11
	Medium (2000ms)	DLY2RR2000	4-11
	Long (3000ms)	DLY2RR3000	4-11
	Extra Long (4000ms)	DLY2RR4000	4-11
Character Activation Mode	*Off	HSTCEN0	4-11
	On	HSTCEN1	4-11
	Activation Character	HSTACH##	4-11
	Do Not End Character Activation After Good Read	HSTCGD0	4-12
	*End Character Activation After Good Read	HSTCGD1	4-12
	Character Activation Timeout (Range 1 - 65525) *5000 ms	HSTCDT#####	4-12
Character Deactivation Mode	*Off	HSTDEN0	4-12
	On	HSTDEN1	4-12
	Deactivation Character	HSTDCH##	4-12
User-Specified Reread Delay	Range 0 - 30,000 ms	DLYRRD#####	4-10
Illumination Lights	*Lights On	SCNLED1	4-13
	Lights Off	SCNLED0	4-13
Aimer Delay	200 milliseconds	SCNDLY200	4-13
	400 milliseconds	SCNDLY400	4-13
	*Off (no delay)	SCNDLY0	4-13
User-Specified Aimer Delay	Range 0 - 4,000 ms	SCNDLY####	4-13
Aimer Mode	Off	SCNAIM0	4-13
	*Interlaced	SCNAIM2	4-14
Centering Window	Centering On	DECWIN1	4-14
	*Centering Off	DECWIN0	4-15
	Left of Centering Window (*40%)	DECLFT###	4-15
	Right of Centering Window (*60%)	DECRGT###	4-15
	Top of Centering Window (*40%)	DECTOP###	4-15
	Bottom of Centering Window (*60%)	DECBOT###	4-15
No Read	On	SHWNRD1	4-15
	*Off	SHWNRD0	4-15
Video Reverse	Video Reverse Only	VIDREV1	4-16
	Video Reverse and Standard Bar Codes	VIDREV2	4-16
	*Video Reverse Off	VIDREV0	4-16
Working Orientation	*Upright	ROTATN0	4-17
	Vertical, Bottom to Top (Rotate CCW 90°)	ROTATN1	4-17
	Upside Down	ROTATN2	4-17
	Vertical, Top to Bottom (Rotate CW 90°)	ROTATN3	4-17
<b>Prefix/Suffix Selections</b>			
Add CR Suffix to All Symbologies		VSUF CR	5-2
Prefix	Add Prefix	PREBK2##	5-2

<b>Selection</b>	<b>Setting</b> <i>* Indicates default</i>	<b>Serial Command</b> <i># Indicates a numeric entry</i>	<b>Page</b>
	Clear One Prefix	PRECL2	5-2
	Clear All Prefixes	PRECA2	5-2
Suffix	Add Suffix	SUFBK2##	5-2
	Clear One Suffix	SUFCL2	5-2
	Clear All Suffixes	SUFCA2	5-2
Function Code Transmit	*Enable	RMVFNC0	5-3
	Disable	RMVFNC1	5-3
Intercharacter Delay	Range 0 - 1000 (5ms increments)	DLYCHR##	5-3
User Specified Intercharacter Delay	Delay Length 0 - 1000 (5ms increments)	DLYCRX##	5-4
	Character to Trigger Delay	DLY_XX##	5-4
Interfunction Delay	Range 0 - 1000 (5ms increments)	DLYFNC##	5-4
Intermessage Delay	Range 0 - 1000 (5ms increments)	DLYMSG##	5-4
<b>Data Formatter Selections</b>			
Data Format Editor	*Default Data Format (None)	DFMDF3	6-1
	Enter Data Format	DFMBK3##	6-2
	Clear One Data Format	DFMCL3	6-2
	Clear All Data Formats	DFMCA3	6-2
Data Formatter	Data Formatter Off	DFM_EN0	6-9
	*Data Formatter On, Not Required, Keep Prefix/Suffix	DFM_EN1	6-9
	Data Format Required, Keep Prefix/Suffix	DFM_EN2	6-9
Primary/Alternate Data Formats	Primary Data Format	ALTFNM0	6-9
	Data Format 1	ALTFNM1	6-9
	Data Format 2	ALTFNM2	6-9
	Data Format 3	ALTFNM3	6-10
<b>Symbologies</b>			
All Symbologies	All Symbologies Off	ALLENA0	7-1
	All Symbologies On	ALLENA1	7-1
Codabar	Default All Codabar Settings	CBRDFT	7-2
	Off	CBRENA0	7-2
	*On	CBRENA1	7-2
Codabar Start/Stop Char.	*Don't Transmit	CBRSSX0	7-2
	Transmit	CBRSSX1	7-2
Codabar Check Char.	*No Check Char.	CBRCK20	7-3
	Validate, But Don't Transmit	CBRCK21	7-3
	Validate, and Transmit	CBRCK22	7-3
Codabar Concatenation	*Off	CBRCCT0	7-3
	On	CBRCCT1	7-3
	Require	CBRCCT2	7-3

<b>Selection</b>	<b>Setting</b> <i>* Indicates default</i>	<b>Serial Command</b> <i># Indicates a numeric entry</i>	<b>Page</b>
Codabar Message Length	Minimum (2 - 60) *4	CBRMIN##	7-3
	Maximum (2 - 60) *60	CBRMAX##	7-4
Code 39	Default All Code 39 Settings	C39DFT	7-4
	Off	C39ENA0	7-4
	*On	C39ENA1	7-4
Code 39 Start/Stop Char.	*Don't Transmit	C39SSX0	7-4
	Transmit	C39SSX1	7-4
Code 39 Check Char.	*No Check Char.	C39CK20	7-4
	Validate, But Don't Transmit	C39CK21	7-5
	Validate, and Transmit	C39CK22	7-5
Code 39 Message Length	Minimum (0 - 48) *0	C39MIN##	7-5
	Maximum (0 - 48) *48	C39MAX##	7-5
Code 39 Append	*Off	C39APP0	7-5
	On	C39APP1	7-5
Code 32 Pharmaceutical (PARAF)	*Off	C39B320	7-5
	On	C39B321	7-5
Code 39 Full ASCII	*Off	C39ASC0	7-6
	On	C39ASC1	7-6
	Code 39 Code Page	C39DCP	7-6
Interleaved 2 of 5	Default All Interleaved 2 of 5 Settings	I25DFT	7-7
	Off	I25ENA0	7-7
	*On	I25ENA1	7-7
Interleaved 2 of 5 Check Digit	*No Check Char.	I25CK20	7-7
	Validate, But Don't Transmit	I25CK21	7-7
	Validate, and Transmit	I25CK22	7-7
Interleaved 2 of 5 Message Length	Minimum (2 - 80) *4	I25MIN##	7-7
	Maximum (2 - 80) *80	I25MAX##	7-8
NEC 2 of 5	Default All NEC 2 of 5 Settings	N25DFT	7-8
	Off	N25ENA0	7-8
	*On	N25ENA1	7-8
NEC 2 of 5 Check Digit	*No Check Char.	N25CK20	7-8
	Validate, But Don't Transmit	N25CK21	7-8
	Validate, and Transmit	N25CK22	7-8
NEC 2 of 5 Message Length	Minimum (2 - 80) *4	N25MIN##	7-9
	Maximum (2 - 80) *80	N25MAX##	7-9



<b>Selection</b>	<b>Setting</b> <i>* Indicates default</i>	<b>Serial Command</b> <i># Indicates a numeric entry</i>	<b>Page</b>
Code 93	Default All Code 93 Settings	C93DFT	<a href="#">7-9</a>
	Off	C93ENA0	<a href="#">7-9</a>
	*On	C93ENA1	<a href="#">7-11</a>
Code 93 Message Length	Minimum (0 - 80) *0	C93MIN##	<a href="#">7-9</a>
	Maximum (0 - 80) *80	C93MAX##	<a href="#">7-9</a>
Code 93 Append	On	C93APP1	<a href="#">7-10</a>
	*Off	C93APP0	<a href="#">7-10</a>
Code 93 Code Page	Code 93 Code Page	C93DCP	<a href="#">7-10</a>
Straight 2 of 5 Industrial	Default All Straight 2 of 5 Industrial Settings	R25DFT	<a href="#">7-11</a>
	*Off	R25ENA0	<a href="#">7-11</a>
	On	R25ENA1	<a href="#">7-11</a>
Straight 2 of 5 Industrial Message Length	Minimum (1 - 48) *4	R25MIN##	<a href="#">7-11</a>
	Maximum (1 - 48) *48	R25MAX##	<a href="#">7-11</a>
Straight 2 of 5 IATA	Default All Straight 2 of 5 IATA Settings	A25DFT	<a href="#">7-12</a>
Straight 2 of 5 IATA	*Off	A25ENA0	<a href="#">7-12</a>
	On	A25ENA1	<a href="#">7-12</a>
Straight 2 of 5 IATA Message Length	Minimum (1 - 48) *4	A25MIN##	<a href="#">7-12</a>
	Maximum (1 - 48) *48	A25MAX##	<a href="#">7-12</a>
Matrix 2 of 5	Default All Matrix 2 of 5 Settings	X25DFT	<a href="#">7-13</a>
	*Off	X25ENA0	<a href="#">7-13</a>
	On	X25ENA1	<a href="#">7-13</a>
Matrix 2 of 5 Message Length	Minimum (1 - 80) *4	X25MIN##	<a href="#">7-13</a>
	Maximum (1 - 80) *80	X25MAX##	<a href="#">7-13</a>
Code 11	Default All Code 11 Settings	C11DFT	<a href="#">7-14</a>
	*Off	C11ENA0	<a href="#">7-14</a>
	On	C11ENA1	<a href="#">7-14</a>
Code 11 Check Digits Required	1 Check Digit	C11CK20	<a href="#">7-14</a>
	*2 Check Digits	C11CK21	<a href="#">7-14</a>
Code 11 Message Length	Minimum (1 - 80) *4	C11MIN##	<a href="#">7-14</a>
	Maximum (1 - 80) *80	C11MAX##	<a href="#">7-14</a>
Code 128	Default All Code 128 Settings	128DFT	<a href="#">7-15</a>
	Off	128ENA0	<a href="#">7-15</a>
	*On	128ENA1	<a href="#">7-15</a>
ISBT Concatenation	*Off	ISBENA0	<a href="#">7-15</a>
	On	ISBENA1	<a href="#">7-15</a>
Code 128 Message Length	Minimum (0 - 80) *0	128MIN##	<a href="#">7-15</a>
	Maximum (0 - 80) *80	128MAX##	<a href="#">7-15</a>

<b>Selection</b>	<b>Setting</b> <i>* Indicates default</i>	<b>Serial Command</b> <i># Indicates a numeric entry</i>	<b>Page</b>
Code 128 Append	*On	128APP1	<a href="#">7-15</a>
	Off	128APP0	<a href="#">7-16</a>
Code 128 Code Page	Code 128 Code Page (*2)	128DCP##	<a href="#">7-16</a>
GS1-128	Default All GS1-128 Settings	GS1DFT	<a href="#">7-17</a>
	*On	GS1ENA1	<a href="#">7-17</a>
	Off	GS1ENA0	<a href="#">7-17</a>
GS1-128 Message Length	Minimum (1 - 80) *1	GS1MIN##	<a href="#">7-17</a>
	Maximum (0 - 80) *80	GS1MAX##	<a href="#">7-17</a>
UPC-A	Default All UPC-A Settings	UPADFT	<a href="#">7-17</a>
	Off	UPAENA0	<a href="#">7-18</a>
	*On	UPAENA1	<a href="#">7-18</a>
UPC-A Check Digit	Off	UPACKX0	<a href="#">7-17</a>
	*On	UPACKX1	<a href="#">7-18</a>
UPC-A Number System	Off	UPANSX0	<a href="#">7-18</a>
	*On	UPANSX1	<a href="#">7-18</a>
UPC-A 2 Digit Addenda	*Off	UPAAD20	<a href="#">7-18</a>
	On	UPAAD21	<a href="#">7-18</a>
UPC-A 5 Digit Addenda	*Off	UPAAD50	<a href="#">7-18</a>
	On	UPAAD51	<a href="#">7-18</a>
UPC-A Addenda Required	*Not Required	UPAARQ0	<a href="#">7-19</a>
	Required	UPAARQ1	<a href="#">7-19</a>
UPC-A Addenda Separator	Off	UPAADS0	<a href="#">7-19</a>
	*On	UPAADS1	<a href="#">7-19</a>
UPC-A/EAN-13 with Extended Coupon Code	*Off	CPNENA0	<a href="#">7-19</a>
	Allow Concatenation	CPNENA1	<a href="#">7-19</a>
	Require Concatenation	CPNENA2	<a href="#">7-19</a>
Coupon GS1 DataBar Output	GS1 Output Off	CPNGS10	<a href="#">7-20</a>
	GS1 Output On	CPNGS11	<a href="#">7-20</a>
UPC-E0	Default All UPC-E Settings	UPEDFT	<a href="#">7-20</a>
	Off	UPEEN00	<a href="#">7-20</a>
	*On	UPEEN01	<a href="#">7-20</a>
UPC-E0 Expand	*Off	UPEEXP0	<a href="#">7-20</a>
	On	UPEEXP1	<a href="#">7-20</a>
UPC-E0 Addenda Required	Required	UPEARQ1	<a href="#">7-21</a>
	*Not Required	UPEARQ0	<a href="#">7-21</a>
UPC-E0 Addenda Separator	*On	UPEADS1	<a href="#">7-21</a>
	Off	UPEADS0	<a href="#">7-21</a>
UPC-E0 Check Digit	Off	UPECKX0	<a href="#">7-21</a>
	*On	UPECKX1	<a href="#">7-21</a>
UPC-E0 Number System	Off	UPENSX0	<a href="#">7-21</a>
	*On	UPENSX1	<a href="#">7-21</a>

<b>Selection</b>	<b>Setting</b> <i>* Indicates default</i>	<b>Serial Command</b> <i># Indicates a numeric entry</i>	<b>Page</b>
UPC-E0 Addenda	2 Digit Addenda On	UPEAD21	<a href="#">7-22</a>
	*2 Digit Addenda Off	UPEAD20	<a href="#">7-22</a>
	5 Digit Addenda On	UPEAD51	<a href="#">7-22</a>
	*5 Digit Addenda Off	UPEAD50	<a href="#">7-22</a>
UPC-E1	*Off	UPEEN10	<a href="#">7-22</a>
	On	UPEEN11	<a href="#">7-22</a>
EAN/JAN-13	Default All EAN/ JAN Settings	E13DFT	<a href="#">7-23</a>
	Off	E13ENA0	<a href="#">7-23</a>
	*On	E13ENA1	<a href="#">7-23</a>
EAN/JAN-13 Check Digit	Off	E13CKX0	<a href="#">7-23</a>
	*On	E13CKX1	<a href="#">7-23</a>
EAN/JAN-13 2 Digit Addenda	2 Digit Addenda On	E13AD21	<a href="#">7-24</a>
	*2 Digit Addenda Off	E13AD20	<a href="#">7-24</a>
	5 Digit Addenda On	E13AD51	<a href="#">7-24</a>
	*5 Digit Addenda Off	E13AD50	<a href="#">7-24</a>
EAN/JAN-13 Addenda Required	*Not Required	E13ARQ0	<a href="#">7-24</a>
	Required	E13ARQ1	<a href="#">7-24</a>
EAN/JAN-13 Addenda Separator	Off	E13ADS0	<a href="#">7-24</a>
	*On	E13ADS1	<a href="#">7-24</a>
ISBN Translate	*Off	E13ISB0	<a href="#">7-25</a>
	On	E13ISB1	<a href="#">7-25</a>
EAN/JAN-8	Default All EAN/ JAN 8 Settings	EA8DFT	<a href="#">7-25</a>
	Off	EA8ENA0	<a href="#">7-25</a>
	*On	EA8ENA1	<a href="#">7-25</a>
EAN/JAN-8 Check Digit	Off	EA8CKX0	<a href="#">7-25</a>
	*On	EA8CKX1	<a href="#">7-25</a>
EAN/JAN-8 Addenda	*2 Digit Addenda Off	EA8AD20	<a href="#">7-26</a>
	2 Digit Addenda On	EA8AD21	<a href="#">7-26</a>
	*5 Digit Addenda Off	EA8AD50	<a href="#">7-26</a>
	5 Digit Addenda On	EA8AD51	<a href="#">7-26</a>
EAN/JAN-8 Addenda Required	*Not Required	EA8ARQ0	<a href="#">7-26</a>
	Required	EA8ARQ1	<a href="#">7-26</a>
EAN/JAN-8 Addenda Separator	Off	EA8ADS0	<a href="#">7-26</a>
	*On	EA8ADS1	<a href="#">7-26</a>
MSI	Default All MSI Settings	MSIDFT	<a href="#">7-27</a>
	*Off	MSIENA0	<a href="#">7-27</a>
	On	MSIENA1	<a href="#">7-27</a>
MSI Check Character	*Validate Type 10, but Don't Transmit	MSICHK0	<a href="#">7-27</a>
	Validate Type 10 and Transmit	MSICHK1	<a href="#">7-27</a>

<b>Selection</b>	<b>Setting</b> <i>* Indicates default</i>	<b>Serial Command</b> <i># Indicates a numeric entry</i>	<b>Page</b>
	Validate 2 Type 10 Chars, but Don't Transmit	MSICLK2	<a href="#">7-27</a>
	Validate 2 Type 10 Chars and Transmit	MSICLK3	<a href="#">7-27</a>
	Validate Type 10 then Type 11 Char, but Don't Transmit	MSICLK4	<a href="#">7-27</a>
	Validate Type 10 then Type 11 Char and Transmit	MSICLK5	<a href="#">7-28</a>
	Disable MSI Check Characters	MSICLK6	<a href="#">7-28</a>
MSI Message Length	Minimum (4 - 48) *4	MSIMIN##	<a href="#">7-28</a>
	Maximum (4 - 48) *48	MSIMAX##	<a href="#">7-28</a>
GS1 DataBar Omnidirectional	Default All GS1 DataBar Omnidirectional Settings	RSSDFT	<a href="#">7-29</a>
	Off	RSEENA0	<a href="#">7-29</a>
	*On	RSEENA1	<a href="#">7-29</a>
GS1 DataBar Limited	Default All GS1 DataBar Limited Settings	RSLDFT	<a href="#">7-29</a>
	Off	RSEENA0	<a href="#">7-29</a>
	*On	RSEENA1	<a href="#">7-29</a>
GS1 DataBar Expanded	Default All GS1 DataBar Expanded Settings	RSEDFT	<a href="#">7-30</a>
	Off	RSEENA0	<a href="#">7-30</a>
	*On	RSEENA1	<a href="#">7-30</a>
GS1 DataBar Expanded Msg. Length	Minimum (4 - 74) *4	RSEMIN##	<a href="#">7-30</a>
	Maximum (4 - 74) *74	RSEMAX##	<a href="#">7-30</a>
Codablock A	Default All Codablock A Settings	CBADFT	<a href="#">7-30</a>
	*Off	CBAENA0	<a href="#">7-30</a>
	On	CBAENA1	<a href="#">7-30</a>
Codablock A Msg. Length	Minimum (1 - 600) *1	CBAMIN####	<a href="#">7-31</a>
	Maximum (1 - 600) *600	CBAMAX####	<a href="#">7-31</a>
Codablock F	Default All Codablock F Settings	CBFDFT	<a href="#">7-31</a>
	*Off	CBFENA0	<a href="#">7-31</a>
	On	CBFENA1	<a href="#">7-31</a>
Codablock F Msg. Length	Minimum (1 - 2048) *1	CBFMIN####	<a href="#">7-31</a>
	Maximum (1 - 2048) *2048	CBFMAX####	<a href="#">7-31</a>
PDF417	Default All PDF417 Settings	PDFDFT	<a href="#">7-32</a>
	*On	PDFENA1	<a href="#">7-32</a>
	Off	PDFENA0	<a href="#">7-32</a>
PDF417 Msg. Length	Minimum (1-2750) *1	PDFMIN####	<a href="#">7-32</a>
	Maximum (1-2750) *2750	PDFMAX####	<a href="#">7-32</a>
MacroPDF417	*On	PDFMAC1	<a href="#">7-32</a>
	Off	PDFMAC0	<a href="#">7-32</a>
MicroPDF417	Default All Micro PDF417 Settings	MPDDFT	<a href="#">7-33</a>
	On	MPDENA1	<a href="#">7-33</a>
	*Off	MPDENA0	<a href="#">7-33</a>

<b>Selection</b>	<b>Setting</b> <i>* Indicates default</i>	<b>Serial Command</b> <i># Indicates a numeric entry</i>	<b>Page</b>
MicroPDF417 Msg. Length	Minimum (1-366) *1	MPDMIN###	7-33
	Maximum (1-366) *366	MPDMAX###	7-33
GS1 Composite Codes	On	COMENA1	7-33
	*Off	COMENA0	7-33
UPC/EAN Version	On	COMUPC1	7-34
	*Off	COMUPC0	7-34
GS1 Composite Codes Msg. Length	Minimum (1-2435) *1	COMMINS###	7-34
	Maximum (1-2435) *2435	COMMINS###	7-34
GS1 Emulation	GS1-128 Emulation	EANEMU1	7-34
	GS1 DataBar Emulation	EANEMU2	7-35
	GS1 Code Expansion Off	EANEMU3	7-35
	EAN8 to EAN13 Conversion	EANEMU4	7-35
	*GS1 Emulation Off	EANEMU0	7-35
TCIF Linked Code 39	On	T39ENA1	7-35
	*Off	T39ENA0	7-35
QR Code	Default All QR Code Settings	QRCDFT	7-40
	*On	QRCENA1	7-35
	Off	QRCENA0	7-35
QR Code Msg. Length	Minimum (1-7089) *1	QRCMINS###	7-36
	Maximum (1-7089) *7089	QRCMAX###	7-36
QR Code Append	*On	QRCAPP1	7-36
	Off	QRCAPP0	7-36
QR Code Page	QR Code Page (*3)	QRCDCP##	7-36
Data Matrix	Default All Data Matrix Settings	IDMDFT	7-37
	*On	IDMENA1	7-37
	Off	IDMENA0	7-37
Data Matrix Msg. Length	Minimum (1-3116) *1	IDMMINS###	7-37
	Maximum (1-3116) *3116	IDMMAX###	7-37
Data Matrix Append	*On	IDMAPP1	7-37
	Off	IDMAPP0	7-37
Data Matrix Code Page	Data Matrix Code Page (*51)	IDMDCP##	7-38
MaxiCode	Default All MaxiCode Settings	MAXDFT	7-38
	On	MAXENA1	7-38
	*Off	MAXENA0	7-38
MaxiCode Msg. Length	Minimum (1-150) *1	MAXMINS###	7-38
	Maximum (1-150) *150	MAXMAX###	7-38
Aztec Code	Default All Aztec Code Settings	AZTDFT	7-39
	*On	AZTENA1	7-39
	Off	AZTENA0	7-39
Aztec Code Msg. Length	Minimum (1-3832) *1	AZTMINS###	7-39
	Maximum (1-3832) *3832	AZTMAX###	7-39
Aztec Append	On	AZTAPP1	7-39
	*Off	AZTAPP0	7-39

<b>Selection</b>	<b>Setting</b> <i>* Indicates default</i>	<b>Serial Command</b> <i># Indicates a numeric entry</i>	<b>Page</b>
Aztec Code Page	Aztec Code Page (*51)	AZTDCP##	7-40
Chinese Sensible (Han Xin) Code	Default All Han Xin Code Settings	HX_DFT	7-40
	On	HX_ENA1	7-40
	*Off	HX_ENA0	7-40
Chinese Sensible (Han Xin) Code Msg. Length	Minimum (1-7833) *1	HX_MIN####	7-40
	Maximum (1-7833) *7833	HX_MAX####	7-40
<b>Postal Codes - Linear</b>			
China Post (Hong Kong 2 of 5)	Default All China Post (Hong Kong 2 of 5) Settings	CPCDFT	7-45
	*Off	CPCENA0	7-45
	On	CPCENA1	7-45
China Post (Hong Kong 2 of 5) Msg. Length	Minimum (2 - 80) *4	CPCMIN##	7-45
	Maximum (2 - 80) *80	CPCMAX##	7-46
Korea Post	Default All Korea Post Settings	KPCDFT	7-46
	*Off	KPCENA0	7-46
	On	KPCENA1	7-46
Korea Post Msg. Length	Minimum (2 - 80) *4	KPCMIN##	7-46
	Maximum (2 - 80) *48	KPCMAX##	7-46
Korea Post Check Digit	Transmit Check Digit	KPCCHK1	7-46
	*Don't Transmit Check Digit	KPCCHK0	7-46
<b>Postal Codes - 2D</b>			
2D Postal Codes	*Off	POSTAL0	7-46
Single 2D Postal Codes	Australian Post On	POSTAL1	7-41
	British Post On	POSTAL7	7-41
	Canadian Post On	POSTAL30	7-41
	Intelligent Mail Bar Code On	POSTAL10	7-41
	Japanese Post On	POSTAL3	7-41
	KIX Post On	POSTAL4	7-41
	Planet Code On	POSTAL5	7-41
	Postal-4i On	POSTAL9	7-41
	Postnet On	POSTAL6	7-42
	Postnet with B and B' Fields On	POSTAL11	7-42
Combination 2D Postal Codes	InfoMail On	POSTAL2	7-42
	InfoMail and British Post On	POSTAL8	7-42
	Intelligent Mail Bar Code and Postnet with B and B' Fields On	POSTAL20	7-42
	Postnet and Postal-4i On	POSTAL14	7-42
	Postnet and Intelligent Mail Bar Code On	POSTAL16	7-42
	Postal-4i and Intelligent Mail Bar Code On	POSTAL17	7-42
	Postal-4i and Postnet with B and B' Fields On	POSTAL19	7-42
	Planet and Postnet On	POSTAL12	7-42
Planet and Postnet with B and B' Fields On	POSTAL18	7-43	

<b>Selection</b>	<b>Setting</b> <i>* Indicates default</i>	<b>Serial Command</b> <i># Indicates a numeric entry</i>	<b>Page</b>
	Planet and Postal-4i On	POSTAL13	<a href="#">7-43</a>
	Planet and Intelligent Mail Bar Code On	POSTAL15	<a href="#">7-43</a>
	Planet, Postnet, and Postal-4i On	POSTAL21	<a href="#">7-43</a>
	Planet, Postnet, and Intelligent Mail Bar Code On	POSTAL22	<a href="#">7-43</a>
	Planet, Postal-4i, and Intelligent Mail Bar Code On	POSTAL23	<a href="#">7-43</a>
	Postnet, Postal-4i, and Intelligent Mail Bar Code On	POSTAL24	<a href="#">7-43</a>
	Planet, Postal-4i, and Postnet with B and B' Fields On	POSTAL25	<a href="#">7-43</a>
	Planet, Intelligent Mail Bar Code, and Postnet with B and B' Fields On	POSTAL26	<a href="#">7-43</a>
	Postal-4i, Intelligent Mail Bar Code, and Postnet with B and B' Fields On	POSTAL27	<a href="#">7-43</a>
	Planet, Postal-4i, Intelligent Mail Bar Code, and Postnet On	POSTAL28	<a href="#">7-44</a>
	Planet, Postal-4i, Intelligent Mail Bar Code, and Postnet with B and B' Fields On	POSTAL29	<a href="#">7-44</a>
Planet Code Check Digit	Transmit	PLNCKX1	<a href="#">7-44</a>
	*Don't Transmit	PLNCKX0	<a href="#">7-44</a>
Postnet Check Digit	Transmit	NETCKX1	<a href="#">7-44</a>
	*Don't Transmit	NETCKX0	<a href="#">7-44</a>
Australian Post Interpretation	Bar Output	AUSINT0	<a href="#">7-45</a>
	Numeric N Table	AUSINT1	<a href="#">7-45</a>
	Alphanumeric C Table	AUSINT2	<a href="#">7-45</a>
	Combination N and C Tables	AUSINT3	<a href="#">7-45</a>
<b>Utilities</b>			
Add Code I.D. Prefix to All Symbolologies (Temporary)		PRECA2,BK2995C80!	<a href="#">8-1</a>
Show Decoder Revision		REV_DR	<a href="#">8-1</a>
Show Scan Driver Revision		REV_SD	<a href="#">8-1</a>
Show Software Revision		REVINF	<a href="#">8-1</a>
Show Data Format		DFMBK3?	<a href="#">8-1</a>
Resetting the Factory Defaults	Remove Custom Defaults	DEFOVR	<a href="#">8-3</a>
	Activate Defaults	DEFALT	<a href="#">8-3</a>





## Product Specifications

### Voyager 1450g Scanner Product Specifications

Parameter	Specification
<b>Mechanical</b>	
Height	3.23 in. (82mm)
Length	2.45 in. (62mm)
Width	6.65 in. (169mm)
Weight	4.6 oz. (130g)
<b>Electrical</b>	
Input Voltage	4.0 - 5.5VDC
Operating Power	2W (400mA @ 5VDC)
Standby Power	.45W (90mA @ 5VDC)
Illumination LED	White emitting color
Aiming	624nm peak wavelength
<b>Environmental</b>	
Operating Temperature	32°F to 104°F (0°C to 40°C)
Storage Temperature	-4°F to 140°F (-20°C to 60°C)
Humidity	5 to 95% non-condensing
Drop	Operational after 30 drops to concrete from 5 ft. (1.5m)
Environmental Sealing	IP40
Light Levels	0 to 100,000 lux (9,290 foot-candles)
ESD	15kV Air, 8kV contact
<b>Image</b>	
Image Size	640 x 480 pixels
<b>Scan Performance</b>	
Pitch, Skew	±60°, ±70°
Motion Tolerance: Presentation Mode	up to 10cm per second for 13 mil UPC
Symbol Contrast	35%
<b>Depth of Field</b>	
<b>Typical Performance</b>	
5 mil Code 39	45 - 107mm (1.8 - 4.2 in.)
13 mil UPC-A	37 - 260mm (1.4 - 10.2 in.)
20 mil Code 39	42 - 360mm (1.6 - 14.2 in.)
6.7 mil PDF417	42 - 107mm (1.6 - 4.2 in.)
10mil Data Matrix	42 - 107mm (1.6 - 4.2 in.)
20mil QR Code	32 - 210mm (1.2 - 8.3 in.)
<b>Guaranteed Performance</b>	
5 mil Code 39	57 - 102mm (2.2 - 4.0 in.)
13 mil UPC-A	41 - 207mm (1.6 - 8.1 in.)
20 mil Code 39	45 - 300mm (1.8 - 11.8 in.)
6.7 mil PDF417	45 - 100mm (1.8 - 3.9 in.)
10mil Data Matrix	50 - 98mm (2.0 - 3.8 in.)
20mil QR Code	35 - 190mm (1.4 - 7.5 in.)

## Voyager 1450g2DHR Scanner Product Specifications

<b>Parameter</b>	<b>Specification</b>
<b>Mechanical</b>	
Height	3.23 in. (82mm)
Length	2.45 in. (62mm)
Width	6.65 in. (169mm)
Weight	4.6 oz. (130g)
<b>Electrical</b>	
Input Voltage	4.0 - 5.5VDC
Operating Power	2.25W (450mA @ 5VDC)
Standby Power	.45W (90mA @ 5VDC)
Illumination LED	624nm peak wavelength red LED
Aiming	520nm peak wavelength green LED
<b>Environmental</b>	
Operating Temperature	32°F to 104°F (0°C to 40°C)
Storage Temperature	-40°F to 140°F (-40°C to 60°C)
Humidity	5 to 95% non-condensing
Drop	Operational after 30 drops to concrete from 5 ft. (1.5m)
Environmental Sealing	IP42
Light Levels	0 to 100,000 lux (9,290 foot-candles)
ESD	15kV Air, 8kV contact
<b>Image</b>	
Image Size	1280 x 800 pixels
<b>Scan Performance</b>	
Pitch, Skew	±60°, ±70°
Motion Tolerance: Presentation Mode	up to 10cm per second for 13 mil UPC
Symbol Contrast	35%
<b>Depth of Field</b>	
<b>Typical Performance</b>	
5 mil Code 39	58 - 145mm (2.3 - 5.7 in.)
13 mil UPC-A	28 - 254mm (1.1 - 10 in.)
20 mil Code 39	30 - 325mm (1.2 - 12.8 in.)
6.7 mil PDF417	38 - 160mm (1.5 - 6.3 in.)
10mil Data Matrix	36 - 130mm (1.4 - 5.1 in.)
20mil QR Code	46 - 216mm (1.8 - 8.5 in.)
<b>Guaranteed Performance</b>	
5 mil Code 39	66 - 121mm (2.6 - 4.8 in.)
13 mil UPC-A	35 - 224mm (1.4 - 8.8 in.)
20 mil Code 39	33 - 249mm (1.3 - 9.8 in.)
6.7 mil PDF417	49 - 138mm (1.9 - 5.4 in.)
10mil Data Matrix	45 - 100mm (1.8 - 3.9 in.)
20mil QR Code	57 - 166mm (2.2 - 6.5 in.)

## Voyager 1452g Cordless Scanner Product Specifications

Parameter	Specification
<b>Mechanical</b>	
Height	6.8 in. (17.3cm)
Length	3.2 in. (8.2cm)
Width	2.5 in. (6.2cm)
Weight	7.3 oz. (210g)
<b>Electrical</b>	
Battery: Lithium Ion	2400 mAH lithium-ion
Number of Scans	Up to 40,000 per charge
Expected Hours of Operation	14
Expected Charge Time	4.5 hours
Illumination LED	White emitting color
Aiming	624nm peak wavelength
<b>Radio</b>	
Frequency	2.4 to 2.5 GHz (ISM Band) Frequency Hopping Bluetooth v.2.1
Range	33 ft. (10 m) typical
Data Rate	Up to 1 MBps
<b>Environmental</b>	
Operating Temperature	41° F to 104° F (5° C to 40° C)
Storage Temperature (with battery)	-4°F to 95°F (-20°C to 35°C) storage for 90 days -4°F to 68°F (-20°C to 20°C) storage for 1 year
Humidity	Up to 95% non-condensing
Drop	Operational after 30 drops to concrete from 5 ft. (1.5 m)
Environmental Sealing	IP42
Vibration	Withstands 5G peak from 5 to 300 Hz
ESD	12kV Air, 8kV contact
<b>Image</b>	
Image Size	640 x 480 pixels
<b>Scan Performance</b>	
Pitch, Skew	±60°, ±70°
Motion Tolerance: Presentation Mode	up to 10cm per second for 13 mil UPC
Symbol Contrast	35%
<b>Depth of Field</b>	
<b>Typical Performance</b>	
5 mil Code 39	45 - 107mm (1.8 - 4.2 in.)
13 mil UPC	37 - 260mm (1.4 - 10.2 in.)
20 mil Code 39	42 - 360mm (1.6 - 14.2 in.)
6.7 mil PDF417	42 - 107mm (1.6 - 4.2 in.)
10mil Data Matrix	42 - 107mm (1.6 - 4.2 in.)
20mil QR Code	32 - 210mm (1.2 - 8.3 in.)
<b>Guaranteed Performance</b>	
5 mil Code 39	57 - 102mm (2.2 - 4.0 in.)
13 mil UPC-A	41 - 207mm (1.6 - 8.1 in.)

Parameter	Specification
20 mil Code 39	45 - 300mm (1.8 - 11.8 in.)
6.7 mil PDF417	45 - 100mm (1.8 - 3.9 in.)
10mil Data Matrix	50 - 98mm (2.0 - 3.8 in.)
20mil QR Code	35 - 190mm (1.4 - 7.5 in.)

\*Storage outside of this temperature range could be detrimental to battery life.

## ***CCB01-010BT Charge Base Product Specifications***

Parameter	Specification
Dimensions (Typical):	
Height	3.2 inches (8.13cm)
Length	5.19 inches (13.18cm)
Width	3.98 inches (10.11cm)
Weight	6.3 oz (179g)
Voltage:	4.5 to 5.5 volts
Current Draw:	
Host Terminal Port	500mA
Aux Power Port	1A
Charge Time	5 hours
Radio:	
Frequency	2.4 to 2.5 GHz (ISM Band) Frequency Hopping Bluetooth v.2.1
Range	33 ft. (10 m) typical
Data Rate	Up to 1 MBps
Temperature Ranges:	
Operating	32° F to +122° F (0° C to +50° C)
Battery Charge	41° F to +104° F (5° C to +40° C)
Storage	-40° F to +158° F (-40° C to +70° C)
Humidity	Up to 95% non-condensing
Mechanical Drop	Operational after 50 drops from 3.28 feet (1 m) to concrete
Vibration	5G Peak from 22Hz to 300Hz
ESD Sensitivity	Up to 15kV direct air Up to 8 kV indirect coupling plane
Sealant Rating	IP41

---

## Standard Cable Pinouts

*Note: The following pin assignments are not compatible with Honeywell legacy products. Use of a cable with improper pin assignments may lead to damage to the unit. Use of any cables not provided by the manufacturer may result in damage not covered by your warranty.*

### Keyboard Wedge

10 Pin RJ41 Modular Plug

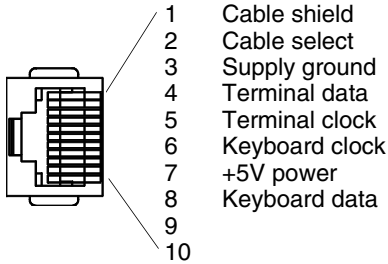

### Serial Output

10 Pin RJ41 Modular Plug

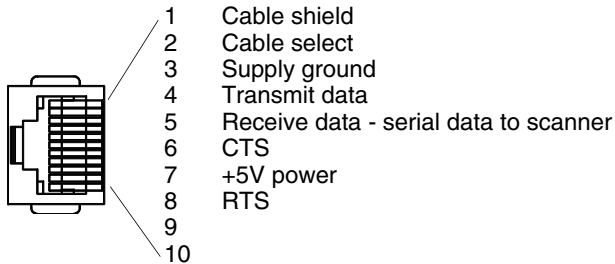

### USB

10 Pin Modular Plug

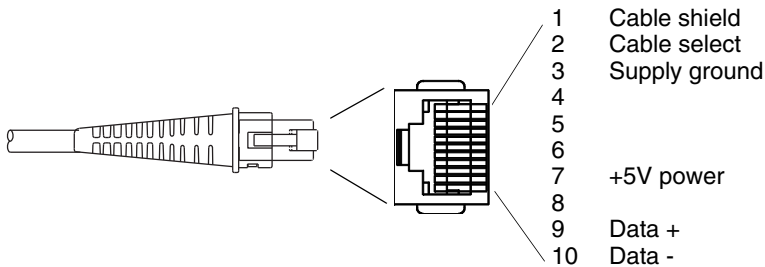

---

## **RS485 Output**

10 Pin RJ41 Modular Plug

*Note: RS485 signal conversion is performed in the cable.*

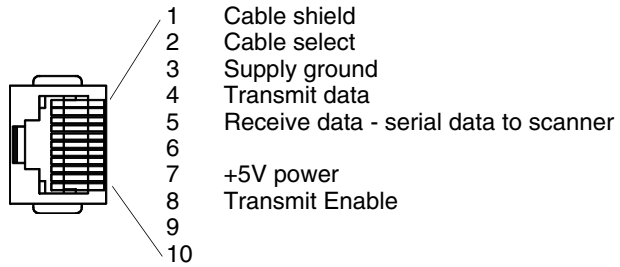

---

**Required Safety Labels**

**Voyager 1450g/1452g Scanner**

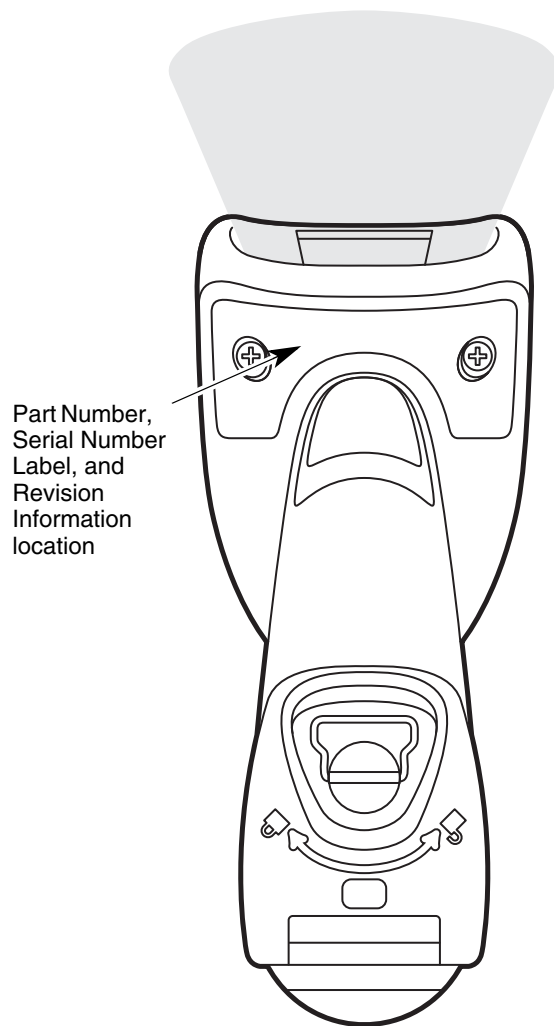

---

**CCB01-010BT Base**

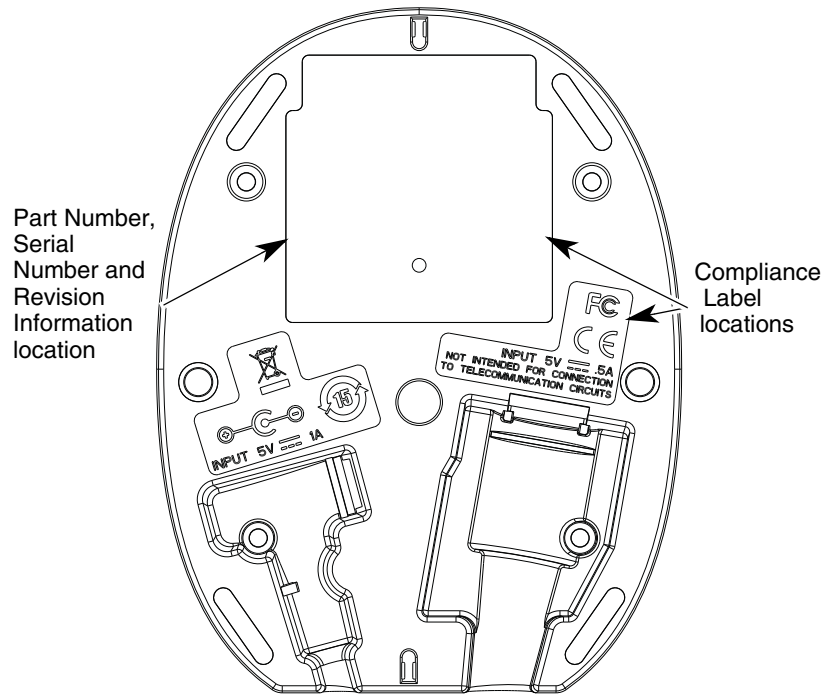



## Maintenance and Troubleshooting

### Repairs

Repairs and/or upgrades are not to be performed on this product. These services are to be performed only by an authorized service center (see [Customer Support](#) on page -ix).

### Maintenance

Your device provides reliable and efficient operation with a minimum of care. Although specific maintenance is not required, the following periodic checks ensure dependable operation:

#### Cleaning the Device

Reading performance may degrade if the scanner's window is not clean. If the window is visibly dirty, or if the scanner isn't operating well, clean the window with a soft cloth or lens tissue dampened with water (or a mild detergent- water solution). If a detergent solution is used, rinse with a clean lens tissue dampened with water only.

The scanner and base's housing may also be cleaned the same way.



#### **Caution:**

**Do not submerge the scanner in water. The scanner's housing is not watertight.**

**Do not use abrasive wipes or tissues on the scanner's window – abrasive wipes may scratch the window. Never use solvents (e.g., alcohol or acetone) on the housing or window – solvents may damage the finish or the window.**

#### Inspecting Cords and Connectors

Inspect the interface cable and connector for wear or other signs of damage. A badly worn cable or damaged connector may interfere with scanner operation. Contact your distributor for information about cable replacement. Cable replacement instructions are on [page 11-1](#).

#### Replacing Cables in Corded Scanners

The standard interface cable is attached to the scanner with an 10-pin modular connector. When properly seated, the connector is held in the scanner's handle by a flexible retention tab. The interface cable is designed to be field replaceable.

- Order replacement cables from Honeywell or from an authorized distributor.
- When ordering a replacement cable, specify the cable part number of the original interface cable.

---

### ***Replacing a Corded Scanner Interface Cable***

1. Turn the power to the host system OFF.
2. Disconnect the scanner's cable from the terminal or computer.
3. Locate the small hole on the back of the scanner's handle. This is the cable release.
4. Straighten one end of a paper clip.
5. Insert the end of the paper clip into the small hole and press in. This depresses the retention tab, releasing the connector. Pull the connector out while maintaining pressure on the paper clip, then remove the paper clip.
6. Replace with the new cable.  
Insert the connector into the opening and press firmly. The connector is keyed to go in only one way, and will click into place.

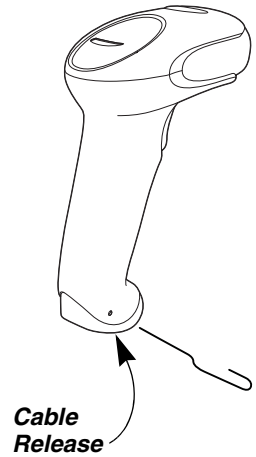

### ***Replacing Cables and Batteries in Cordless Systems***

#### ***Replacing an Interface Cable in a Base***

1. Turn the power to the host system OFF.
2. Disconnect the base's cable from the terminal or computer.
3. Turn the base upside down.
4. Pull the connector out while maintaining pressure on the connector release clip.

**CCB01-010BT Base :**

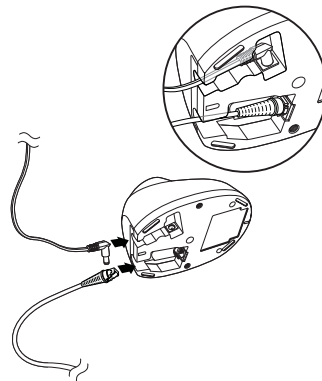

5. Replace with the new cable.  
Insert the connector into the opening and press firmly. The connector is keyed to go in only one way, and will click into place.

---

## Changing a Cordless Scanner Battery

1. Use the hinged wire or a flat head screwdriver to remove the screw from the end cap.
2. Remove the end cap and remove the battery from the handle.
3. Insert replacement battery.
4. Replace end cap and screw it back on.

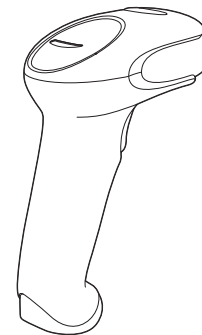

End Cap

## Troubleshooting a Corded Scanner

The scanner automatically performs self-tests whenever you turn it on. If your scanner is not functioning properly, review the following Troubleshooting Guide to try to isolate the problem.

### Is the power on? Is the aimer on?

If the aimer isn't illuminated, check that:

- The cable is connected properly.
- The host system power is on (if external power isn't used).
- The trigger works.

### Is the scanner having trouble reading your symbols?

If the scanner isn't reading symbols well, check that the scanner window is clean and that the symbols:

- Aren't smeared, rough, scratched, or exhibiting voids.
- Aren't coated with frost or water droplets on the surface.
- Are enabled in the scanner or in the decoder to which the scanner connects.

### Is the bar code displayed but not entered?

The bar code is displayed on the host device correctly, but you still have to press a key to enter it (the Enter/Return key or the Tab key, for example).

- You need to program a suffix. Programming a suffix enables the scanner to output the bar code data plus the key you need (such as "CR") to enter the data into your application. Refer to [Prefix/Suffix Overview](#) beginning on page 5-1 for further information.

### The scanner won't read your bar code at all.

- Scan the sample bar codes in the back of this manual. If the scanner reads the sample bar codes, check that your bar code is readable.  
Verify that your bar code symbology is enabled (see [Chapter 7](#)).

If the scanner still can't read the sample bar codes, scan [All Symbologies](#) (page 7-1).

If you aren't sure what programming options have been set in the scanner, or if you want the factory default settings restored, refer to [Resetting the Custom Defaults](#) on page 9-3.

## Troubleshooting a Cordless System

### Troubleshooting a Base

*Note:* Visit the Services and Support section of our website ([www.honeywellaidc.com](http://www.honeywellaidc.com)) to check for the latest software for both the scanner and the base.

If your base is not functioning properly, review the following troubleshooting guidelines to try to isolate the problem.

#### Is the red LED on?

If the red LED isn't illuminated, check that:

- The power cable is connected properly and there is power at the power source.
- The host system power is on (if external power isn't used).

#### Is the green LED on?

If the green LED isn't illuminated, check that:

- 
- The scanner is correctly placed in the base.
  - There is external power or 12 volt host power.
  - Charge mode is turned on. (See ["Beeper and LED Sequences and Meaning" on page 3-5](#))
  - The battery is not bad or deeply discharged. In some cases, the scanner's battery may trickle charge to bring it into an acceptable level and then transition to a normal charge cycle.

### **Troubleshooting a Cordless Scanner**

*Note: Make sure that your scanner's battery is charged. Visit the Services and Support section of our website ([www.honeywellaidc.com](http://www.honeywellaidc.com)) to check for the latest software for both the scanner and the base or Access Point.*

#### **Is the scanner having trouble reading your symbols?**

If the scanner isn't reading symbols well, check that the symbols:

- Aren't smeared, rough, scratched, or exhibiting voids.
- Aren't coated with frost or water droplets on the surface.
- Are enabled in the base or Access Point to which the scanner connects.

#### **Is the bar code displayed but not entered into the application?**

The bar code is displayed on the host device correctly, but you still have to press a key to enter it (the Enter/Return key or the Tab key, for example).

- You need to program a suffix. Programming a suffix enables the scanner to output the bar code data plus the key you need (such as "CR") to enter the data into your application. Refer to [Prefix/Suffix Overview](#) on page 5-1 for further information.

#### **The scanner won't read your bar code at all.**

- Scan the sample bar codes in the back of this manual. If the scanner reads the sample bar codes, check that your bar code is readable.

Verify that your bar code symbology is enabled (see [Chapter 7](#)).

If the scanner still can't read the sample bar codes, scan [All Symbologies](#) on page 7-1.

## Reference Charts

### Symbology Charts

Note: “m” represents the AIM modifier character. Refer to International Technical Specification, Symbology Identifiers, for AIM modifier character details.

Prefix/Suffix entries for specific symbologies override the universal (All Symbologies, 99) entry.

Refer to [Data Editing](#) beginning on page 5-1 and [Data Formatting](#) beginning on page 6-1 for information about using Code ID and AIM ID.

### Linear Symbologies

Symbology	AIM		Honeywell	
	ID	Possible modifiers (m)	ID	Hex
All Symbologies				99
Codabar	]Fm	0-1	a	61
Code 11	]H3		h	68
Code 128	]Cm	0, 1, 2, 4	j	6A
Code 32 Pharmaceutical (PARAF)	]X0		<	3C
Code 39 (supports Full ASCII mode)	]Am	0, 1, 3, 4, 5, 7	b	62
TCIF Linked Code 39 (TLC39)	]L2		T	54
Code 93 and 93i	]Gm	0-9, A-Z, a-m	i	69
EAN	]Em	0, 1, 3, 4	d	64
EAN-13 (including Bookland EAN)	]E0		d	64
EAN-13 with Add-On	]E3		d	64
EAN-13 with Extended Coupon Code	]E3		d	64
EAN-8	]E4		D	44
EAN-8 with Add-On	]E3		D	44
GS1				
GS1 DataBar	]em	0	y	79
GS1 DataBar Limited	]em		{	7B
GS1 DataBar Expanded	]em		}	7D
GS1-128	]C1		l	49
2 of 5				
China Post (Hong Kong 2 of 5)	]X0		Q	51
Interleaved 2 of 5	]Im	0, 1, 3	e	65
Matrix 2 of 5	]X0		m	6D
NEC 2 of 5	]X0		Y	59
Straight 2 of 5 IATA	]Rm	0, 1, 3	f	66
Straight 2 of 5 Industrial	]S0		f	66
MSI	]Mm	0, 1	g	67
UPC		0, 1, 2, 3, 8, 9, A, B, C		
UPC-A	]E0		c	63

Symbology	AIM		Honeywell	
	ID	Possible modifiers (m)	ID	Hex
UPC-A with Add-On	]E3		c	63
UPC-A with Extended Coupon Code	]E3		c	63
UPC-E	]E0		E	45
UPC-E with Add-On	]E3		E	45
UPC-E1	]X0		E	45

Add Honeywell Code ID				5C80
Add AIM Code ID				5C81
Add Backslash				5C5C
Batch mode quantity			5	35

## 2D Symbologies

Symbology	AIM		Honeywell	
	ID	Possible modifiers (m)	ID	Hex
<i>All Symbologies</i>				99
Aztec Code	]zm	0-9, A-C	z	7A
Chinese Sensible Code (Han Xin Code)	]X0		H	48
Codablock A	]O6	0, 1, 4, 5, 6	V	56
Codablock F	]Om	0, 1, 4, 5, 6	q	71
Code 49	]Tm	0, 1, 2, 4	l	6C
Data Matrix	]dm	0-6	w	77
GS1	]em	0-3	y	79
GS1 Composite	]em	0-3	y	79
GS1 DataBar Omnidirectional	]em	0-3	y	79
MaxiCode	]Um	0-3	x	78
PDF417	]Lm	0-2	r	72
MicroPDF417	]Lm	0-5	R	52
QR Code	]Qm	0-6	s	73
Micro QR Code	]Qm		s	73

## Postal Symbologies

Symbology	AIM		Honeywell	
	ID	Possible modifiers (m)	ID	Hex
<i>All Symbologies</i>				99
Australian Post	]X0		A	41
British Post	]X0		B	42

Symbology	AIM		Honeywell	
	ID	Possible modifiers (m)	ID	Hex
Canadian Post	]X0		C	43
China Post	]X0		Q	51
InfoMail	]X0		,	2c
Intelligent Mail Bar Code	]X0		M	4D
Japanese Post	]X0		J	4A
KIX (Netherlands) Post	]X0		K	4B
Korea Post	]X0		?	3F
Planet Code	]X0		L	4C
Postal-4i	]X0		N	4E
Postnet	]X0		P	50

## ASCII Conversion Chart (Code Page 1252)

In keyboard applications, ASCII Control Characters can be represented in 3 different ways, as shown below. The CTRL+X function is OS and application dependent. The following table lists some commonly used Microsoft functionality. This table applies to U.S. style keyboards. Certain characters may differ depending on your Country Code/PC regional settings.

Non-printable characters		ASCII control	Keyboard Control + ASCII (CTRL+X) Mode		
DEC	HEX	Char	Control + X Mode Off (KBDCAS0)	Windows Mode Control + X Mode On (KBDCAS2)	
				CTRL + X	CTRL + X function
0	00	NUL	Reserved	CTRL+ @	
1	01	SOH	NP Enter	CTRL+ A	Select all
2	02	STX	Caps Lock	CTRL+ B	Bold
3	03	ETX	ALT Make	CTRL+ C	Copy
4	04	EOT	ALT Break	CTRL+ D	Bookmark
5	05	ENQ	CTRL Make	CTRL+ E	Center
6	06	ACK	CTRL Break	CTRL+ F	Find
7	07	BEL	Enter / Ret	CTRL+ G	
8	08	BS	(Apple Make)	CTRL+ H	History
9	09	HT	Tab	CTRL+ I	Italic
10	0A	LF	(Apple Break)	CTRL+ J	Justify
11	0B	VT	Tab	CTRL+ K	hyperlink
12	0C	FF	Delete	CTRL+ L	list, left align
13	0D	CR	Enter / Ret	CTRL+ M	
14	0E	SO	Insert	CTRL+ N	New
15	0F	SI	ESC	CTRL+ O	Open
16	10	DLE	F11	CTRL+ P	Print
17	11	DC1	Home	CTRL+ Q	Quit
18	12	DC2	PrtScn	CTRL+ R	
19	13	DC3	Backspace	CTRL+ S	Save
20	14	DC4	Back Tab	CTRL+ T	
21	15	NAK	F12	CTRL+ U	
22	16	SYN	F1	CTRL+ V	Paste
23	17	ETB	F2	CTRL+ W	

Non-printable characters		ASCII control	Keyboard Control + ASCII (CTRL+X) Mode		
DEC	HEX	Char	Control + X Mode Off (KBDCAS0)	Windows Mode Control + X Mode On (KBDCAS2)	
				CTRL + X	CTRL + X function
24	18	CAN	F3	CTRL+ X	
25	19	EM	F4	CTRL+ Y	
26	1A	SUB	F5	CTRL+ Z	
27	1B	ESC	F6	CTRL+ [	
28	1C	FS	F7	CTRL+ \	
29	1D	GS	F8	CTRL+ ]	
30	1E	RS	F9	CTRL+ ^	
31	1F	US	F10	CTRL+ -	
127	7F	␣	NP Enter		

## Lower ASCII Reference Table

Note: Windows Code page 1252 and lower ASCII use the same characters.

Printable Characters								
DEC	HEX	Character	DEC	HEX	Character	DEC	HEX	Character
32	20	<SPACE>	64	40	@	96	60	`
33	21	!	65	41	A	97	61	a
34	22	"	66	42	B	98	62	b
35	23	#	67	43	C	99	63	c
36	24	\$	68	44	D	100	64	d
37	25	%	69	45	E	101	65	e
38	26	&	70	46	F	102	66	f
39	27	'	71	47	G	103	67	g
40	28	(	72	48	H	104	68	h
41	29	)	73	49	I	105	69	i
42	2A	*	74	4A	J	106	6A	j
43	2B	+	75	4B	K	107	6B	k
44	2C	,	76	4C	L	108	6C	l
45	2D	-	77	4D	M	109	6D	m
46	2E	.	78	4E	N	110	6E	n
47	2F	/	79	4F	O	111	6F	o
48	30	0	80	50	P	112	70	p
49	31	1	81	51	Q	113	71	q
50	32	2	82	52	R	114	72	r
51	33	3	83	53	S	115	73	s
52	34	4	84	54	T	116	74	t
53	35	5	85	55	U	117	75	u
54	36	6	86	56	V	118	76	v
55	37	7	87	57	W	119	77	w
56	38	8	88	58	X	120	78	x
57	39	9	89	59	Y	121	79	y
58	3A	:	90	5A	Z	122	7A	z
59	3B	;	91	5B	[	123	7B	{
60	3C	<	92	5C	\	124	7C	
61	3D	=	93	5D	]	125	7D	}
62	3E	>	94	5E	^	126	7E	~
63	3F	?	95	5F	_	127	7F	␣



Extended ASCII Characters					
DEC	HEX	CP 1252	ASCII	Alternate Extended	PS2 Scan Code
128	80	€	Ç	up arrow ↑	0x48
129	81		ü	down arrow ↓	0x50
130	82	,	é	right arrow →	0x4B
131	83	f	â	left arrow ←	0x4D
132	84	„	ä	Insert	0x52
133	85	…	à	Delete	0x53
134	86	†	á	Home	0x47
135	87	‡	ç	End	0x4F
136	88	^	ê	Page Up	0x49
137	89	‰	ë	Page Down	0x51
138	8A	Š	è	Right ALT	0x38
139	8B	‹	ï	Right CTRL	0x1D
140	8C	Œ	î	Reserved	n/a
141	8D		ì	Reserved	n/a
142	8E	Ž	Ä	Numeric Keypad Enter	0x1C
143	8F		Å	Numeric Keypad /	0x35
144	90		É	F1	0x3B
145	91	‘	æ	F2	0x3C
146	92	’	Æ	F3	0x3D
147	93	“	ô	F4	0x3E
148	94	”	ö	F5	0x3F
149	95	•	ò	F6	0x40
150	96	—	ù	F7	0x41
151	97	—	û	F8	0x42
152	98	˜	ÿ	F9	0x43
153	99	™	ÿ	F10	0x44
154	9A	š	Ü	F11	0x57
155	9B	›	Ÿ	F12	0x58
156	9C	œ	£	Numeric Keypad +	0x4E
157	9D		¥	Numeric Keypad -	0x4A
158	9E	ž	Ps	Numeric Keypad *	0x37
159	9F	ÿ	f	Caps Lock	0x3A
160	A0		á	Num Lock	0x45
161	A1	ı	í	Left Alt	0x38
162	A2	ç	ó	Left Ctrl	0x1D
163	A3	£	ú	Left Shift	0x2A
164	A4	¤	ñ	Right Shift	0x36
165	A5	¥	Ñ	Print Screen	n/a
166	A6		ª	Tab	0x0F
167	A7	§	º	Shift Tab	0x8F
168	A8	¨	¿	Enter	0x1C
169	A9	©	ƒ	Esc	0x01
170	AA	ª	ƒ	Alt Make	0x36
171	AB	«	½	Alt Break	0xB6
172	AC	¬	¼	Control Make	0x1D
173	AD		ı	Control Break	0x9D
174	AE	®	«	Alt Sequence with 1 Character	0x36
175	AF	—	»	Ctrl Sequence with 1 Character	0x1D
176	B0	°	␣		
177	B1	±	␣		
178	B2	²	␣		

Extended ASCII Characters (Continued)					
DEC	HEX	CP 1252	ASCII	Alternate Extended	PS2 Scan Code
179	B3	³			
180	B4	´			
181	B5	µ			
182	B6	¶			
183	B7	·			
184	B8	¸			
185	B9	¹			
186	BA	º			
187	BB	»			
188	BC	¼			
189	BD	½			
190	BE	¾			
191	BF	¿			
192	C0	À			
193	C1	Á			
194	C2	Â			
195	C3	Ã			
196	C4	Ä			
197	C5	Å			
198	C6	Æ			
199	C7	Ç			
200	C8	È			
201	C9	É			
202	CA	Ê			
203	CB	Ë			
204	CC	Ì			
205	CD	Í			
206	CE	Î			
207	CF	Ï			
208	D0	Ð			
209	D1	Ñ			
210	D2	Ò			
211	D3	Ó			
212	D4	Ô			
213	D5	Õ			
214	D6	Ö			
215	D7	×			
216	D8	Ø			
217	D9	Ù			
218	DA	Ú			
219	DB	Û			
220	DC	Ü			
221	DD	Ý			
222	DE	Þ			
223	DF	ß			
224	E0	à	α		
225	E1	á	β		
226	E2	â	γ		
227	E3	ã	π		
228	E4	ä	Σ		
229	E5	å	σ		
230	E6	æ	μ		

Extended ASCII Characters (Continued)					
DEC	HEX	CP 1252	ASCII	Alternate Extended	PS2 Scan Code
231	E7	ç	τ		
232	E8	è	ϕ		
233	E9	é	⊖		
234	EA	ê	Ω		
235	EB	ë	δ		
236	EC	ì	∞		
237	ED	í	φ		
238	EE	î	ε		
239	EF	ï	∩		
240	F0	ð	≡		
241	F1	ñ	±		
242	F2	ò	≥		
243	F3	ó	≤		
244	F4	ô	∫		
245	F5	õ	∫		
246	F6	ö	÷		
247	F7	÷	≈		
248	F8	ø	°		
249	F9	ù	·		
250	FA	ú	·		
251	FB	û	√		
252	FC	ü	ⁿ		
253	FD	ý	²		
254	FE	þ	■		
255	FF	ÿ			

## ISO 2022/ISO 646 Character Replacements

Code pages define the mapping of character codes to characters. If the data received does not display with the proper characters, it may be because the bar code being scanned was created using a code page that is different from the one the host program is expecting. If this is the case, select the code page with which the bar codes were created. The data characters should then appear properly.

Code Page Selection Method/Country	Standard	Keyboard Country	Honeywell Code Page Option
United States (standard ASCII)	ISO/IEC 646-IRV	n/a	1
Automatic National Character Replacement	ISO/IEC 2022	n/a	2 (default)
Binary Code page	n/a	n/a	3
<i>Default "Automatic National Character replacement" will select the below Honeywell Code Page options for Code 128, Code 39 and Code 93.</i>			
United States	ISO/IEC 646-06	0	1
Canada	ISO /IEC 646-121	54	95
Canada	ISO /IEC 646-122	18	96
Japan	ISO/IEC 646-14	28	98
China	ISO/IEC 646-57	92	99
Great Britain (UK)	ISO /IEC 646-04	7	87
France	ISO /IEC 646-69	3	83

Code Page Selection Method/Country	Standard	Keyboard Country	Honeywell Code Page Option
Germany	ISO/IEC646-21	4	84
Switzerland	ISO /IEC 646-CH	6	86
Sweden / Finland (extended Annex C)	ISO/IEC 646-11	2	82
Ireland	ISO /IEC 646-207	73	97
Denmark	ISO/IEC 646-08	8	88
Norway	ISO/IEC 646-60	9	94
Italy	ISO/IEC 646-15	5	85
Portugal	ISO/IEC 646-16	13	92
Spain	ISO/IEC 646-17	10	90
Spain	ISO/IEC 646-85	51	91

Dec			35	36	64	91	92	93	94	96	123	124	125	126
Hex			23	24	40	5B	5C	5D	5E	60	7B	7C	7D	7E
US	0	1	#	\$	@	[	\	]	^	`	{		}	~
CA	54	95	#	\$	à	â	ç	ê	î	ô	é	ù	è	û
CA	18	96	#	\$	à	â	ç	ê	É	ô	é	ù	è	û
JP	28	98	#	\$	@	[	¥	]	^	`	{		}	-
CN	92	99	#	¥	@	[	\	]	^	`	{		}	-
GB	7	87	£	\$	@	[	\	]	^	`	{		}	~
FR	3	83	£	\$	à	°	ç	§	^	μ	é	ù	è	..
DE	4	84	#	\$	§	Ä	Ö	Ü	^	`	ä	ö	ü	ß
CH	6	86	ù	\$	à	é	ç	ê	î	ô	ä	ö	ü	û
SE/FI	2	82	#	¤	É	Ä	Ö	Å	Ü	é	ä	ö	å	ü
DK	8	88	#	\$	@	Æ	Ø	Å	^	`	æ	ø	å	~
NO	9	94	#	\$	@	Æ	Ø	Å	^	`	æ	ø	å	-
IE	73	97	£	\$	Ó	É	Í	Ú	Á	ó	é	í	ú	á
IT	5	85	£	\$	§	°	ç	é	^	ù	à	ò	è	ì
PT	13	92	#	\$	§	Ã	Ç	Õ	^	`	ã	ç	õ	°
ES	10	90	#	\$	§	i	Ñ	¿	^	`	°	ñ	ç	~
ES	51	91	#	\$	·	i	Ñ	Ç	¿	`	´	ñ	ç	..
COUNTRY	Country Keyboard	Honeywell CodePage	ISO / IEC 646 National Character Replacements											

## Unicode Key Maps

6E	70	71	72	73	74	75	76	77	78	79	7A	7B	7C	7D	7E	5A	5F	64	69	
01	02	03	04	05	06	07	08	09	0A	0B	0C	0D	0F	4B	50	55	5B	60	65	6A
10	11	12	13	14	15	16	17	18	19	1A	1B	1C	1D	4C	51	56	5C	61	66	6C
1E	1F	20	21	22	23	24	25	26	27	28	29	2B		53		5D	62	67	6C	
2C	2E	2F	30	31	32	33	34	35	36	37	39	4F	54	59	63	68				
3A	3B	3C			3D				3E	3F	38	40								

104 Key U.S. Style Keyboard

6E	70	71	72	73	74	75	76	77	78	79	7A	7B	7C	7D	7E	5A	5F	64	69	
01	02	03	04	05	06	07	08	09	0A	0B	0C	0D	0F	4B	50	55	5B	60	65	6A
10	11	12	13	14	15	16	17	18	19	1A	1B	1C	2B	4C	51	56	5C	61	66	6C
1E	1F	20	21	22	23	24	25	26	27	28	29	2A		53		5D	62	67	6C	
2C	2D	2E	2F	30	31	32	33	34	35	36	37	39	4F	54	59	63	68			
3A	3B	3C			3D				3E	3F	38	40								

105 Key European Style Keyboard



---

# Sample Symbols

**UPC-A**



0 123456 7890

**Interleaved 2 of 5**



1234567890

**EAN-13**

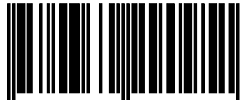

9 780330 290951

**Code 128**



Code 128

**Code 39**

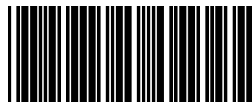

BC321

**Codabar**



A13579B

**Code 93**



123456-9\$

**Straight 2 of 5 Industrial**

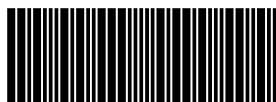

123456

---

---

**Matrix 2 of 5**



6543210

**GS1 DataBar**



(01)00123456789012

**PDF417**



Car Registration

**Data Matrix**



Test Symbol

**QR Code**



Numbers

**Aztec**



Package Label

**MaxiCode**

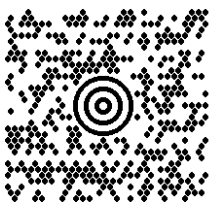

Test Message

**Micro PDF417**



Test Message

**Postnet**



Zip Code

---



---

**4-CB (4-State Customer Bar Code)**



01,234,567094,987654321,01234567891

**ID-tag (UPU 4-State)**



J18CUSA8E6N062315014880T

---

---

# *Programming Chart*



---

# Programming Chart



KAK  
A



KBK  
B



KCK  
C



KDK  
D



KEK  
E



KFK  
F



MNUSAV.  
Save



MNUABT.  
Discard



RESET\_  
Reset

*Note: If you make an error while scanning the letters or digits (before scanning Save), scan Discard, scan the correct letters or digits, and **Save** again.*

**Honeywell Scanning & Mobility**

9680 Old Bailes Road  
Fort Mill, SC 29707

[www.honeywellaidc.com](http://www.honeywellaidc.com)