

***MH240/MH340/MH640/  
MH240T/MH340T/MH640T/  
MH240P/MH340P/MH640P Series***

**THERMAL TRANSFER / DIRECT THERMAL  
BAR CODE PRINTER**

**USER'S  
MANUAL**

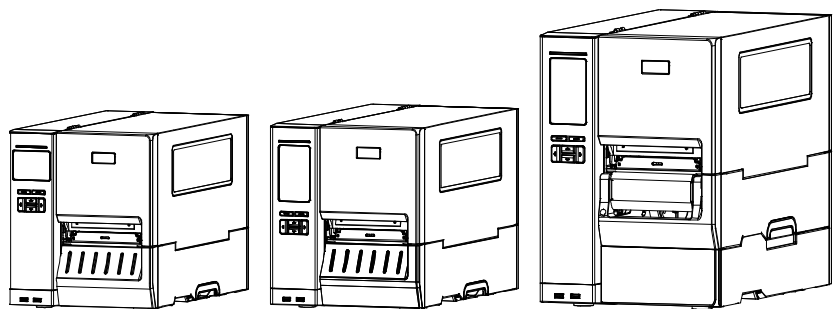

## **Copyright Information**

©2017 TSC Auto ID Technology Co., Ltd,

The copyright in this manual, the software and firmware in the printer described therein are owned by TSC Auto ID Technology Co., Ltd, All rights reserved.

CG Triumvirate is a trademark of Agfa Corporation. CG Triumvirate Bold Condensed font is under license from the Monotype Corporation. Windows is a registered trademark of Microsoft Corporation.

All other trademarks are the property of their respective owners.

Information in this document is subject to change without notice and does not represent a commitment on the part of TSC Auto ID Technology Co. No part of this manual may be reproduced or transmitted in any form or by any means, for any purpose other than the purchaser's personal use, without the expressed written permission of TSC Auto ID Technology Co.

## Agency Compliance and Approvals

---

EN 55032, Class A

EN 55024



EN 60950-1

This is a class A product. In a domestic environment this product may cause radio interference in which case the user may be required to take adequate measures.

---

FCC part 15B, Class A

ICES-003, Class A

This equipment has been tested and found to comply with the limits for a Class A digital device, pursuant to Part 15 of the FCC Rules. These limits are designed to provide reasonable protection against harmful interference when the equipment is operated in a commercial environment.

This equipment generates, uses, and can radiate radio frequency energy and, if not installed and used in accordance with the manufacturer's instruction manual, may cause harmful interference with radio communications. Operation of this equipment in a residential area is likely to cause harmful interference, in which case you will be required to correct the interference at your own expense.



This Class A digital apparatus complies with Canadian ICES-003.

Cet appareil numérique de la classe A est conforme à la norme NMB-003 du Canada.

This device complies with Part 15 of the FCC Rules. Operation is subject to the following two conditions: (1) This device may cause harmful interference, and (2) this device must accept any interference received, including interference that may cause undesired operation.

---



AS/NZS CISPR 22, Class A

---



UL 60950-1 (2nd Edition)  
CSA C22.2 No. 60950-1-07 (2nd Edition)

---



EN 60950-1

---



KN 32

KN 35

---

---

이 기기는 업무용(A 급) 전자파적합기기로서 판매자 또는 사용자는 이 점을 주의하시기 바라며, 가정외의 지역에서 사용하는 것을 목적으로 합니다.

---

GB 4943.1

GB 9254, Class A



GB 17625.1

此为 A 级产品，在生活环境中，该产品可能会造成无线电干扰，在这种情况下，可能需要用户对干扰采取切实可行的措施。

---



Energy Star for Imaging Equipment Version 2.0

---



IS 13252(Part 1)/

IEC 60950-1

---

Note: There may have certification differences in the series models, please refer to product label for accuracy.

**Important safety instructions:**

1. Read all of these instructions and keep them for later use.
2. Follow all warnings and instructions on the product.
3. Disconnect the power plug from the AC outlet before cleaning or if fault happened.

Do not use liquid or aerosol cleaners. Using a damp cloth is suitable for cleaning.

4. The mains socket shall be installed near the equipment and easily accessible.
5. The unit must be protected against moisture.
6. Ensure the stability when installing the device, Tipping or dropping could cause damage.
7. Make sure to follow the correct power rating and power type indicated on marking label

provided by manufacture.

8. Please refer to user manual for maximum operation ambient temperature.

**WARNING:**

Hazardous moving parts, keep fingers and other body parts away.

**CAUTION:**

(For equipment with RTC (CR2032) battery or rechargeable battery pack)

Risk of explosion if battery is replaced by an incorrect type.

Dispose of used batteries according to the Instructions as below.

1. DO NOT throw the battery in fire.
2. DO NOT short circuit the contacts.

3. DO NOT disassemble the battery.
4. DO NOT throw the battery in municipal waste.
5. The symbol of the crossed out wheeled bin indicates that the battery should not be placed in municipal waste.



**Caution:** The printhead may be hot and could cause severe burns. Allow the printhead to cool.

**CAUTION:**

Any changes or modifications not expressly approved by the grantee of this device could void the user's authority to operate the equipment.

**CE Statement:**

This equipment complies with EU radiation exposure limits set forth for an uncontrolled environment. This equipment should be installed and operated with minimum distance 20 cm between the radiator & your body.

All operational modes:

2.4GHz: 802.11b, 802.11g, 802.11n (HT20), 802.11n (HT40)

5GHz: 802.11a,

The frequency, mode and the maximum transmitted power in EU are listed below:

2400 MHz – 2483.5 MHz: 19.88 dBm (EIRP)

5150 MHz – 5250 MHz: 17.51 dBm (EIRP)

5150-5350MHz for Only indoor use

5470-5725MHz for indoor/outdoor use

**Restrictions In AZE**

**National restrictions information is provided below**

Frequency Band	Country	Remark
5150-5350MHz	Azerbaijan	No license needed if used indoor and power not exceeding 30mW
5470-5725MHz		

Hereby, TSC Auto ID Technology Co., Ltd. declares that the radio equipment type [Wi-Fi] IEEE 802.11 a/b/g/n is in compliance with Directive 2014/53/EU

The full text of the EU declaration of conformity is available at the following internet address: <http://www.tscprinters.com>

### **RF exposure warning (Wi-Fi)**

This equipment must be installed and operated in accordance with provided instructions and must not be co-located or operating in conjunction with any other antenna or transmitter. End-users and installers must be providing with antenna installation instructions and transmitter operating conditions for satisfying RF exposure compliance.

SAR Value: 0.736 W/kg

### **RF exposure warning (For Bluetooth)**

The equipment complies with FCC RF exposure limits set forth for an uncontrolled environment.

The equipment must not be co-located or operating in conjunction with any other antenna or transmitter.

### **Canada, Industry Canada (IC) Notices**

This Class B digital apparatus complies with Canadian ICES-003 and RSS-210.

Operation is subject to the following two conditions: (1) this device may not cause interference, and (2) this device must accept any interference, including interference that may cause undesired operation of the device.

### **Radio Frequency (RF) Exposure Information**

The radiated output power of the Wireless Device is below the Industry Canada (IC) radio frequency exposure limits. The Wireless Device should be used in such a manner such that the potential for human contact during normal operation is minimized.

This device has been evaluated for and shown compliant with the IC Specific Absorption Rate ("SAR") limits when installed in specific host products operated in portable exposure conditions. **(For Wi-Fi)**

This device has also been evaluated and shown compliant with the IC RF Exposure limits under portable exposure conditions. (Antennas are less than 20 cm of a person's body). **(For Bluetooth)**

### **Canada, avis de l'Industry Canada (IC)**

Cet appareil numérique de classe B est conforme aux normes canadiennes ICES-003 et RSS-210. Son fonctionnement est soumis aux deux conditions suivantes : (1) cet appareil ne doit pas causer d'interférence et (2) cet appareil doit accepter toute interférence, notamment les interférences qui peuvent affecter son fonctionnement.

### **Informations concernant l'exposition aux fréquences radio (RF)**

La puissance de sortie émise par l'appareil sans fil est inférieure à la limite d'exposition aux fréquences radio de l'Industry Canada (IC). Utilisez l'appareil sans fil de façon à minimiser les contacts humains lors du fonctionnement normal.

Ce périphérique a été évalué et démontré conforme aux limites SAR (Specific Absorption Rate – Taux d'absorption spécifique) par l'IC lorsqu'il est connecté à des dispositifs hôtes spécifiques opérant dans des conditions d'utilisation mobile. **(Pour le Wi-Fi)**

Ce périphérique a également été évalué et démontré conforme aux limites d'exposition radio-fréquence par l'IC pour des utilisations par des opérateurs mobiles (les antennes sont à moins de 20 cm du corps d'une personne). **(Pour le Bluetooth)**

**NCC 警語:**

經型式認證合格之低功率射頻電機，非經許可，公司、商號或使用者均不得擅自變更頻率、加大功率或變更原設計之特性及功能。(即低功率電波輻射性電機管理辦法第十二條)

低功率射頻電機之使用不得影響飛航安全及干擾合法通信；經發現有干擾現象時，應立即停用，並改善至無干擾時方得繼續使用。

前項合法通信，指依電信法規定作業之無線電通信。低功率射頻電機須忍受合法通信或工業、科學及醫療用電波輻射性電機設備之干擾。(即低功率電波輻射性電機管理辦法第十四條)

# Contents

1. Introduction.....	0
1.1 Product Introduction .....	0
1.2 Product Features.....	1
<b>1.2.1 Printer Standard Features</b> .....	<b>1</b>
<b>1.2.2 Printer Optional Features</b> .....	<b>3</b>
1.3 Printer Specifications .....	4
1.4 Print Specifications .....	4
1.5 Ribbon Specifications .....	4
1.6 Media Specifications.....	5
2. Operations Overview.....	6
2.1 Unpacking and Inspection .....	6
2.2 Printer Overview .....	6
<b>2.2.1 Front View</b> .....	<b>7</b>
<b>2.2.2 Interior view</b> .....	<b>10</b>
<b>2.2.3 Rear View</b> .....	<b>12</b>
2.3 Operator Control .....	15
<b>2.3.1 LED Indication and Keys</b> .....	<b>17</b>
<b>2.3.2 Main page Icons</b> .....	<b>18</b>
3. Setup .....	19
3.1 Setting up the printer.....	19
3.2 Loading the Ribbon.....	20
3.3 Remove Used Ribbon.....	23
3.4 Loading the Media.....	24
<b>3.4.1 Loading the Media</b> .....	<b>24</b>
<b>3.4.2 Loading the Fanfold/External Media</b> .....	<b>27</b>
<b>3.4.3 Loading Media in Peel-off Mode (Option for MH240P Series)</b> .....	<b>28</b>
<b>3.4.4 Loading Media in Rewind Mode (Option for MH240P Series)</b> .....	<b>30</b>
4. Adjustment Knob .....	33
4.1 Print Head Pressure Adjustment Knob & Print Head Pressure Position Adjustment Knob .....	33
4.2 Ribbon Tension Adjustment Knob Module .....	34



4.3 Mechanism Fine Adjustment to Avoid Ribbon Wrinkles.....	35
5. Diagnostic Tool.....	37
5.1 Start the Diagnostic Tool.....	37
5.2 Printer Function.....	38
5.3 Setting Ethernet by Diagnostic Tool.....	39
<b>5.3.1 Using USB interface to setup Ethernet interface.....</b>	<b>39</b>
<b>5.3.2 Using RS-232 interface to setup Ethernet interface.....</b>	<b>40</b>
<b>5.3.3 Using Ethernet interface to setup Ethernet interface.....</b>	<b>41</b>
6. LCD Menu Function for MH240 Series.....	43
6.1 Enter the Menu.....	43
6.2 Menu Overview.....	44
6.3 Setting.....	45
<b>6.3.1 TSPL.....</b>	<b>45</b>
<b>6.3.2 ZPL2.....</b>	<b>47</b>
6.4 Sensor.....	50
6.5 Interface.....	51
<b>6.5.1 Serial Comm.....</b>	<b>51</b>
<b>6.5.2 Ethernet.....</b>	<b>52</b>
<b>6.5.3 Wi-Fi.....</b>	<b>53</b>
<b>6.5.4 Bluetooth.....</b>	<b>53</b>
6.6 Advanced.....	54
6.7 File Manager.....	56
6.8 Diagnostic.....	57
6.9 Favorites.....	59
7. LCD Menu Function for MH240T/ MH240P Series (touch panel).....	60
7.1 Enter the Menu.....	60
<b>7.1.1 Touch Screen.....</b>	<b>61</b>
7.2 Menu Overview.....	62
7.3 Setting.....	63
<b>7.3.1 TSPL.....</b>	<b>63</b>
<b>7.3.2 ZPL2.....</b>	<b>65</b>
7.4 Sensor.....	68

7.5 Interface .....	69
<b>7.5.1 Serial Comm.</b> .....	<b>69</b>
<b>7.5.2 Ethernet</b> .....	<b>70</b>
<b>7.5.3 Wi-Fi</b> .....	<b>71</b>
<b>7.5.4 Bluetooth</b> .....	<b>71</b>
7.6 Advanced.....	72
7.7 File Manager .....	74
7.8 Diagnostic .....	75
7.9 Favorites.....	77
8. Troubleshooting .....	79
9. Maintenance .....	82
Revise History .....	83

# 1. Introduction

---

## 1.1 Product Introduction

Thank you very much for purchasing TSC bar code printer.

The new high-performance MH240 Series was designed to deliver the cleanest and high quality barcodes. It features a die-cast print mechanism housed in a very strong yet lightweight cabinet. This new design results in a more durable printer that is suited for your most heavy-duty demand cycles.

There have MH240, MH240T, and MH240P Series with nine models available. The MH240/MH240T/MH240P prints at 203 dpi series are at speeds up to an amazing 14 inches per second, MH340/MH340T/MH340P offers higher 300 dpi resolution at speeds up to 12 inches per second, and the MH640/MH640T/MH640P series features 600 dpi high resolution which makes it ideal for printing very small 2D barcodes, graphics, fine print and other ultra-high-resolution images.

The MH240 Series printers are loaded with standard features including a color touch display with brand-new GUI design and six menu buttons to provide a great user experience, support for 600 meter long ribbons, 8" OD media rolls, built-in Ethernet, RS-232 interface, two USB hosts for keyboard and scanner connections, USB 2.0 and serial interfaces. Parallel, GPIO ports, and internal Bluetooth module are available as an option.

This document provides an easy reference for operating the MH240 series. To print label formats, please refer to the instructions provided with your labeling software; if you need to write the custom programs, please refer to the TSPL/TSPL2 programming manual that can be found on TSC website at <http://www.tscprinters.com>.

- Applications
  - Industrial-duty Printing
  - Work in process
  - Compliance labeling
  - Order Fulfillment
  - Distribution
  - Shipping/Receiving
  - Healthcare Labeling and Patient Safety
  - Electronics & Jewelry labeling

## 1.2 Product Features

### 1.2.1 Printer Standard Features

The printer offers the following standard features.

Product standard feature									
Model	STANDARD			ADVANCED					
	MH240	MH340	MH640	MH240T	MH340T	MH640T	MH240P (w/ internal full rewinder)	MH340P (w/ internal full rewinder)	MH640P (w/ internal full rewinder)
<b>Resolution</b>	203 dots/inch (8 dots/mm)	300 dots/inch (12 dots/mm)	600 dots/inch (24 dots/mm)	203 dots/inch (8 dots/mm)	300 dots/inch (12 dots/mm)	600 dots/inch (24 dots/mm)	203 dots/inch (8 dots/mm)	300 dots/inch (12 dots/mm)	600 dots/inch (24 dots/mm)
<b>Printing method</b>	Thermal transfer & direct thermal								
<b>Mechanism</b>	Die-cast base and frame/ Metal cover with two hinges & large clear media view window								
<b>LCD display/ Operation buttons</b>	<ul style="list-style-type: none"> <li>■ Multi-language selectable</li> <li>■ 3.5" color TFT display, 320 x 240 pixel</li> <li>■ 6 operation buttons (menu, feed/pause, up, down, left, right)</li> <li>■ 1 LED (with 2 LEDs / Green &amp; Red)</li> </ul>			<ul style="list-style-type: none"> <li>■ Multi-language selectable</li> <li>■ Large Backlit LCD display (16 bits Color, Resolution 480 x 272 ; Resistive Touch Screen)</li> <li>■ 6 operation buttons (menu, select, up, down, left/pause, right/feed)</li> <li>■ 1 LED (with 2 LEDs / Green &amp; Red)</li> </ul>					
<b>Processor</b>	32-bit RISC high performance processor								
<b>Memory</b>	<ul style="list-style-type: none"> <li>■ 512MB Flash memory</li> <li>■ 256MB SDRAM</li> <li>■ USB device memory (FAT32)</li> <li>■ microSD card, up to 32 GB</li> </ul>								
<b>Interface</b>	<ul style="list-style-type: none"> <li>■ RS-232 (Max. 115,200 bps)</li> <li>■ USB 2.0 (High speed mode)</li> <li>■ Internal Ethernet print server (10/100 Mbps)</li> <li>■ USB host *2 (Front side), connecting USB storage device</li> </ul>								
<b>Sensors</b>	<ul style="list-style-type: none"> <li>■ Gap transmissive sensor (Position adjustable, 9mm → 102mm)</li> <li>■ Black mark reflective sensor (Position adjustable, 15mm → 108mm)</li> <li>■ Ribbon end sensor (transmissive)</li> <li>■ Ribbon encoder sensor</li> <li>■ Head open sensor</li> </ul>			<ul style="list-style-type: none"> <li>■ Gap transmissive sensor (Position adjustable, 9mm → 102mm)</li> <li>■ Black mark reflective sensor (Position adjustable, 15mm → 108mm)</li> <li>■ Ribbon end sensor (transmissive)</li> <li>■ Ribbon encoder sensor</li> <li>■ Head open sensor</li> <li>■ Media near end sensor</li> </ul>					
<b>Internal font</b>	<ul style="list-style-type: none"> <li>■ 8 alpha-numeric bitmap fonts</li> <li>■ One Monotype Imaging® CG Triumvirate Bold Condensed scalable font</li> <li>■ Built-in Monotype True Type Font engine</li> </ul>								

<p><b>Supported code page</b></p>	<ul style="list-style-type: none"> <li>■ Codepage 437 (English - US)</li> <li>■ Codepage 737 (Greek) -</li> <li>■ Codepage 850 (Latin-1)</li> <li>■ Codepage 852 (Latin-2)</li> <li>■ Codepage 855 (Cyrillic) -</li> <li>■ Codepage 857 (Turkish)</li> <li>■ Codepage 860 (Portuguese)</li> <li>■ Codepage 861 (Icelandic) -</li> <li>■ Codepage 862 (Hebrew) -</li> <li>■ Codepage 863 (French Canadian)</li> <li>■ Codepage 864 (Arabic) -</li> <li>■ Codepage 865 (Nordic)</li> <li>■ Codepage 866 (Russian) -</li> <li>■ Codepage 869 (Greek 2) -</li> <li>■ Codepage 950 (Traditional Chinese)</li> <li>■ Codepage 936 (Simplified Chinese)</li> <li>■ Codepage 932 (Japanese)</li> <li>■ Codepage 949 (Korean)</li> <li>■ Codepage 1250 (Latin-2)</li> <li>■ Codepage 1251 (Cyrillic)</li> <li>■ Codepage 1252 (Latin-1)</li> <li>■ Codepage 1253 (Greek)</li> <li>■ Codepage 1254 (Turkish)</li> <li>■ Codepage 1255 (Hebrew) -</li> <li>■ Codepage 1256 (Arabic)</li> <li>■ Codepage 1257 (Baltic)</li> <li>■ Codepage 1258 (Vietnam)</li> <li>■ ISO-8859-1: Latin-1 (Western European)</li> <li>■ ISO-8859-2: Latin-2 (Central European)</li> <li>■ ISO-8859-3: Latin-3 (South European)</li> <li>■ ISO-8859-4: Latin-4 (North European)</li> <li>■ ISO-8859-5: Cyrillic</li> <li>■ ISO-8859-6: Arabic</li> <li>■ ISO-8859-7: Greek</li> <li>■ ISO-8859-8: Hebrew</li> <li>■ ISO-8859-9: Turkish</li> <li>■ ISO-8859-10: Nordic</li> <li>■ ISO-8859-15: Latin-9</li> <li>■ UTF-8</li> </ul>	
<p><b>Supported bar code</b></p>	<p>1D bar code</p> <p>Code128 subsets A.B.C, Code128UCC, EAN128, Interleave 2 of 5, Code 39, Code 93, EAN-13, EAN-8, Codabar, POSTNET, UPC-A, UPC-E, EAN and UPC 2(5) digits, MSI, PLESSEY, China Post, ITF14, EAN14, Code 11, TELPEN, PLANET, Code 49, Deutsche Post Identcode, Deutsche Post Leitcode, LOGMARS, RSS-Stacked, GS1 DataBar.</p>	<p>2D bar code</p> <p>CODABLOCK F mode, DataMatrix, Maxicode, PDF-417, Aztec, MicroPDF417, QR code, RSS Barcode (GS1 Databar)</p>
<p><b>Command set</b></p>	<p>TSPL-EZ™</p>	
<p><b>Font &amp; bar code rotation</b></p>	<p>0, 90, 180, 270 degree</p>	

<b>Others</b>	<ul style="list-style-type: none"> <li>■ Standard for real time clock</li> <li>■ Standard for buzzer</li> <li>■ Standard industry emulations right out of the box including Eltron® and Zebra® language support</li> <li>■ Built-in Monotype True Type Font engine</li> <li>■ Downloadable fonts from PC to printer memory</li> <li>■ Print head pressure force &amp; pressure location adjustable</li> </ul>
---------------	---

### 1.2.2 Printer Optional Features

The printer offers the following optional features.

Product option feature	User option	Dealer option	Factory option
Option Card (GPIO + Parallel)			○
Internal Bluetooth module in front panel			○
Wi-Fi module (Slot-in)		○	
Peel-off module assembly (MH240/MH240T Series only) Minimum label peeling height: 0.5"		○	
Regular cutter (Guillotine cutter) (MH240/MH240T Series only) Media thickness: 0.06 ~ 0.15 mm Media type: receipt and label liner w/o glue		○	
Heavy duty cutter (Guillotine cutter, MH240/MH240T Series only) Media thickness: 0.06 ~ 0.30 mm Media type: receipt, tag, and label liner w/o glue Regular media thickness: 0.12 mm Media type: receipt and label liner w/o glue		○	
Cutter tray	○		
Care label cutter Media thickness: 0.06 ~ 0.15 mm		○	
KP-200 Plus keyboard display unit	○		
KU-007 Plus programmable smart keyboard	○		

**Note:**

**Except for the linerless cutter, all TSC regular/heavy duty/care label cutters DO NOT cut on media with glue.**

## 1.3 Printer Specifications

Printer Specifications									
Model	STANDARD			ADVANCED					
	MH240	MH340	MH640	MH240T	MH340T	MH640T	MH240P (w/ internal full rewinder)	MH340P (w/ internal full rewinder)	MH640P (w/ internal full rewinder)
Physical dimensions	276 mm (W) x 502 mm (D)x 326 mm (H)						276 mm (W) x 502 mm (D) x 412 mm (H)		
Weight	15.35 kg (33.84 lbs)			15.43 kg (34.02 lbs)			18.93 kg (41.73 lbs)		
Power	Internal switching power supply ■ Input: AC 100-240V, 4-2A, 50-60Hz ■ Output: DC 5V, 5A; DC 24V, 7A; DC 36V, 1.4A; Total 243W <b>Note:</b> <b>The max. full web black bar is limited to 5 mm only, otherwise printer may stop printing to protect power supply.</b>								
Environmental condition	Operation: 5 ~ 40°C (41 ~ 104°F), 25~85% non-condensing Storage: -40 ~ 60 °C (-40 ~ 140°F), 10~90% non-condensing								

## 1.4 Print Specifications

Print Specifications	203 dpi models	300 dpi models	600 dpi models
Print head resolution (dots per inch/mm)	203 dots/inch (8 dots/mm)	300 dots/inch (12 dots/mm)	600 dots/inch (24 dots/mm)
Printing method	Thermal transfer and direct thermal		
Dot size (width x length)	0.125 x 0.125 mm (1 mm = 8 dots)	0.084 x 0.084 mm (1 mm = 12 dots)	0.042 x 0.042 mm (1 mm = 24 dots)
Print speed (inches per second)	2,3,...14 ips Up to 14 IPS	2,3,...12 ips Up to 12 IPS	1.5,2,3...6 ips Up to 6 IPS
Max. print width	104 mm (4.09")		
Max. print length	1000" (25,400 mm)	450" (11,430 mm)	100" (2,540 mm)
Printout bias	Vertical: 0.7 ~ 1mm.		

## 1.5 Ribbon Specifications

Ribbon Specifications	
Ribbon outside diameter	Max. 90 mm OD
Ribbon length	600 m
Ribbon core inside diameter	1" (25.4 mm)
Ribbon width	25.4 mm ~ 114.3 mm (1"~4.5")
Ribbon wound type	Ink coated outside wound, ink coated inside wound
Ribbon end type	Transparency

## 1.6 Media Specifications

Media Specifications			
<b>Media roll capacity</b>	Max. 8" (203.2 mm) OD; 1.5" or 3" ID core, Rewind 3" only		
<b>Media core diameter</b>	3" (76.2 mm) or 1.5" (38.1 mm) ID core		
<b>Media type</b>	Continuous, die-cut, black mark, fan-fold, notch, perforated, tag, and care label (outside wound)		
<b>Media wound type</b>	Outside wound		
<b>Media width</b>	20 mm ~ 114 mm (0.78" ~ 4.49")		
<b>Media thickness</b>	0.06 mm ~ 0.28 mm (2.36 ~ 11 mil)		
<b>Label length</b>	<b>203 dpi models</b>	<b>300 dpi models</b>	<b>600 dpi models</b>
	5 mm ~ 25,400 mm (0.20" ~ 1,000")	5 ~ 11,430 mm (0.20" ~ 450")	5 ~ 2,540 mm (0.20" ~ 100")
<b>Black mark</b>	Min. 8 mm (W) x Min. 2 mm (H)		
<b>Gap height</b>	Min. 2 mm		



## 2. Operations Overview

### 2.1 Unpacking and Inspection

This printer has been specially packaged to withstand damage during shipping. Please carefully inspect the packaging and printer upon receiving the bar code printer. Please retain the packaging materials in case you need to reship the printer.

Unpacking the printer, the following items are included in the carton.

- One printer unit (MH240, MH240T, or MH240P Series)
- One quick installation guide
- One power cord
- One USB interface cable

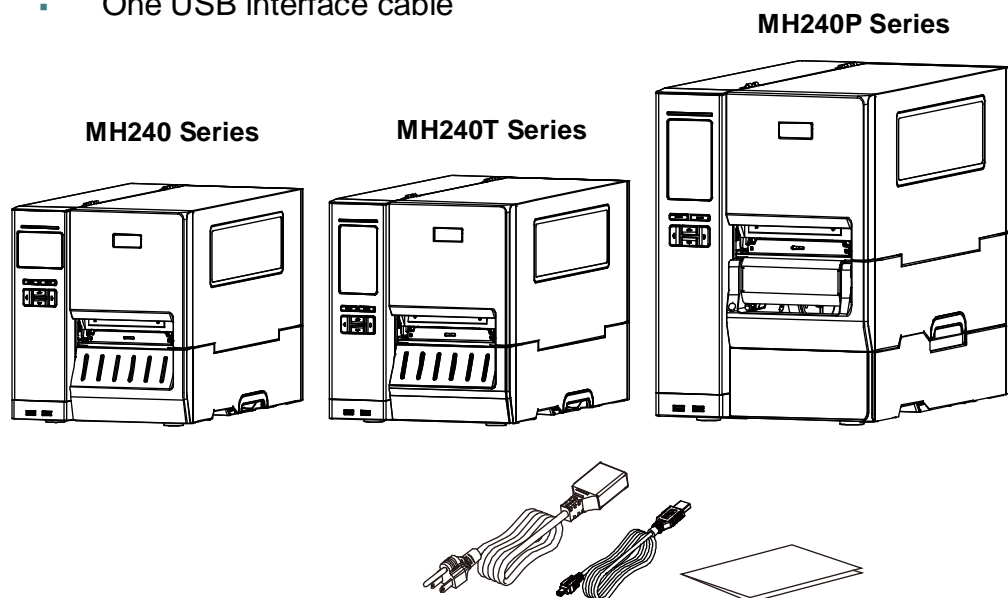

If any parts are missing, please contact the Customer Service Department of your purchased reseller or distributor.

Note: Check the production date

Serial NO.: XXX 17 22 XXXX

YEAR      WEEK  
Год        Неделю

## 2.2 Printer Overview

### 2.2.1 Front View

For MH240 Series

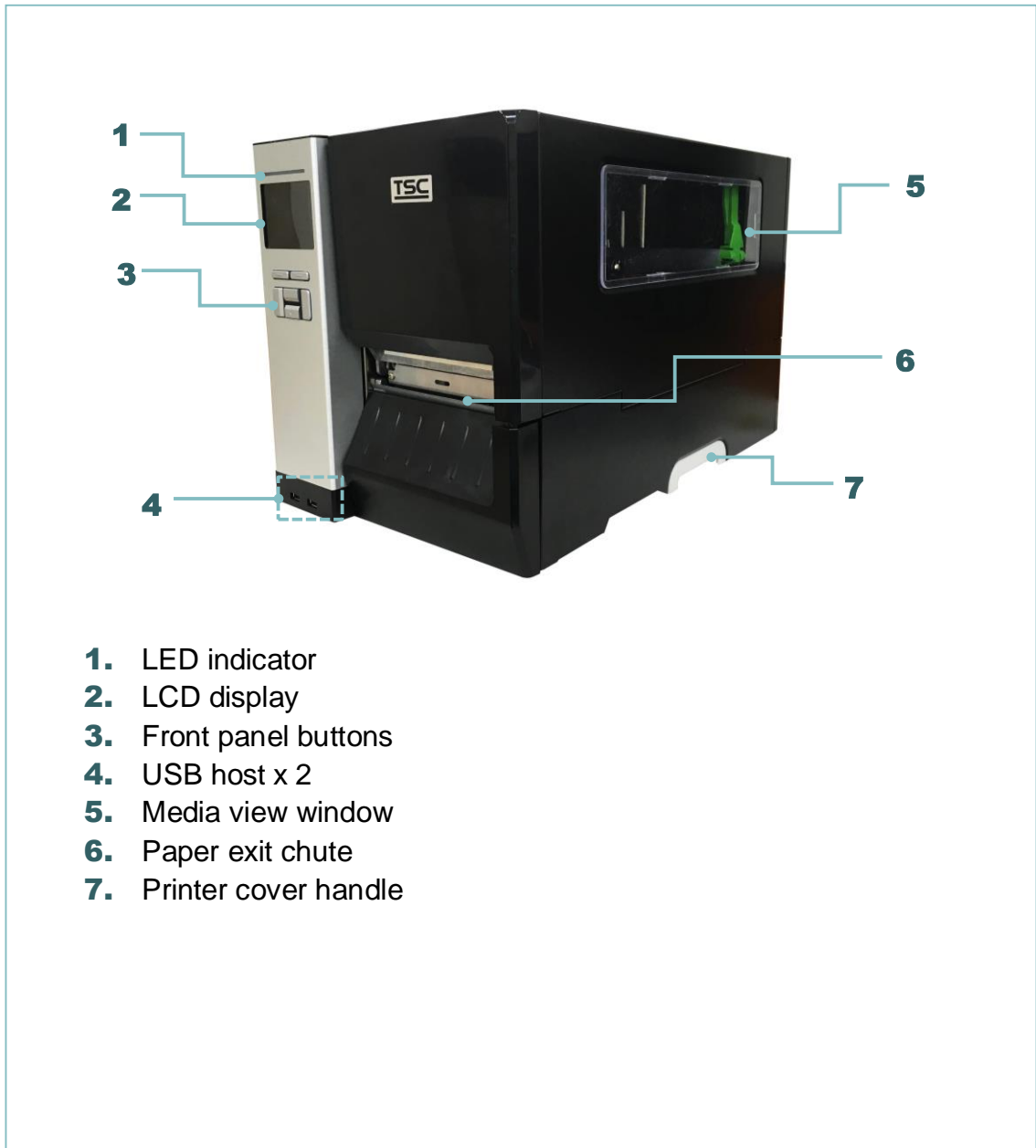

For MH240T Series



- 1. LED indicator
- 2. LCD display
- 3. Front panel buttons
- 4. USB host x 2
- 5. Media view window
- 6. Paper exit chute
- 7. Printer cover handle

For MH240P Series



## 2.2.2 Interior view For MH240 & MH240T Series

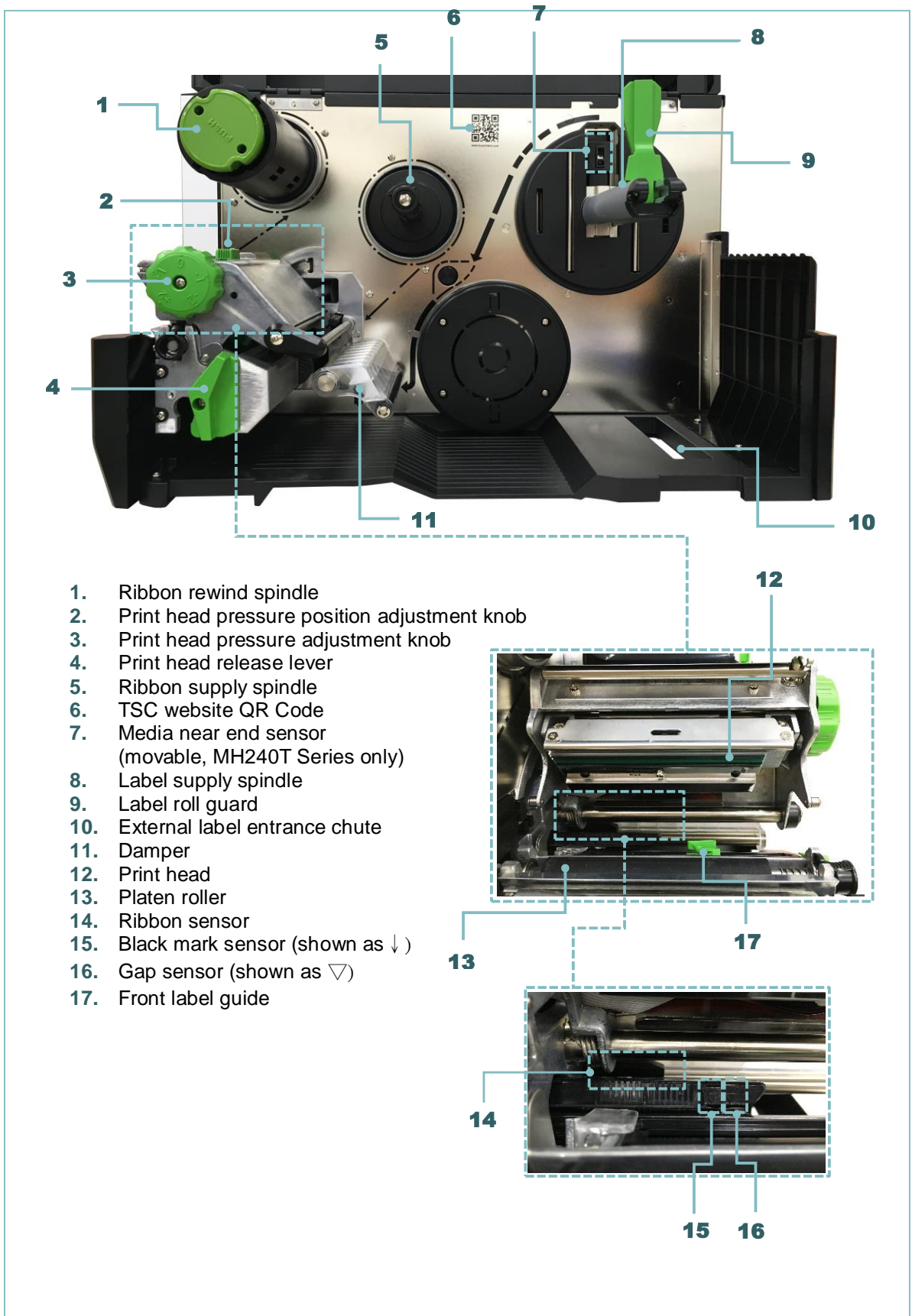

For MH240P Series

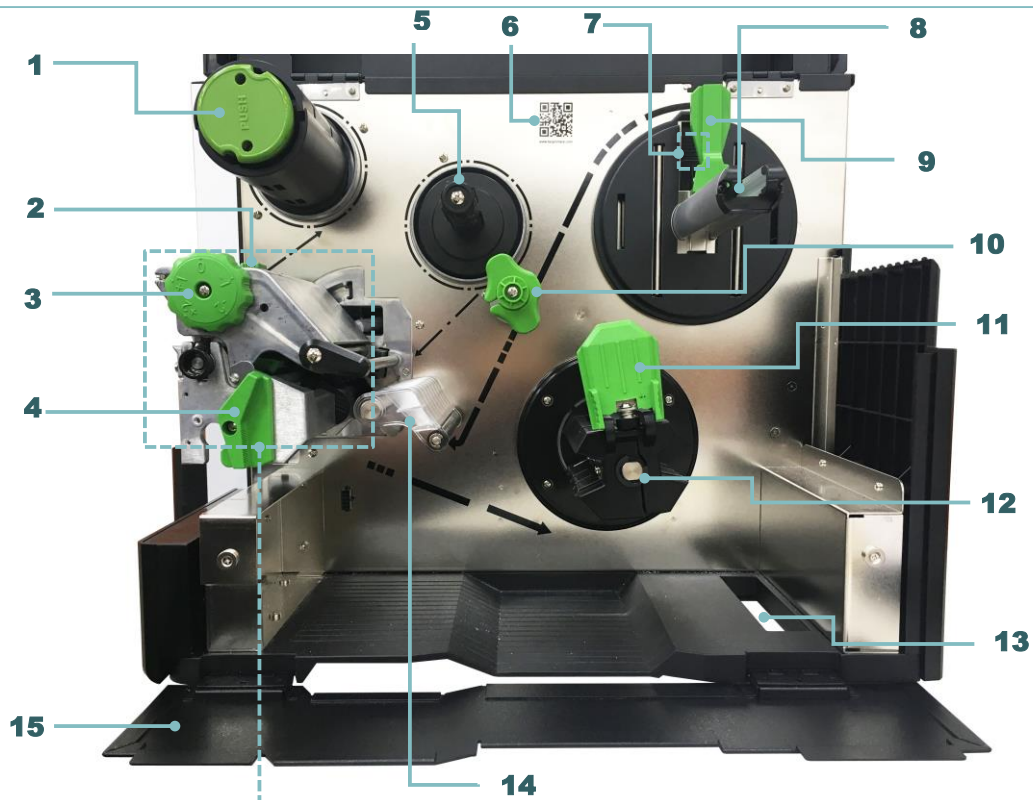

1. Ribbon rewind spindle
2. Print head pressure position adjustment knob
3. Print head pressure adjustment knob
4. Print head release lever
5. Ribbon supply spindle
6. TSC website QR Code
7. Media near end sensor (movable, MH240T/MH240P Series only)
8. Label supply spindle
9. Label roll guard
10. Media guide bar & rear label guide
11. Media rewind guide
12. Media rewind spindle
13. External label entrance chute
14. Damper
15. Printer lower cover
16. Print head
17. Platen roller
18. Ribbon sensor
19. Black mark sensor (shown as ↓)
20. Gap sensor (shown as ▽)
21. Label guide

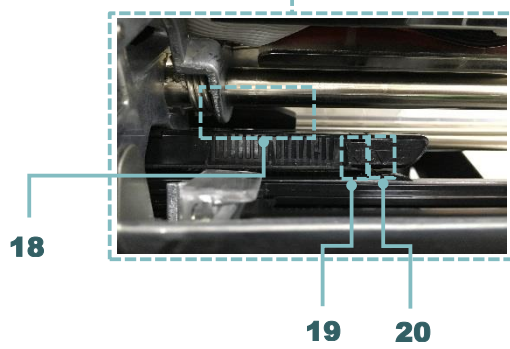
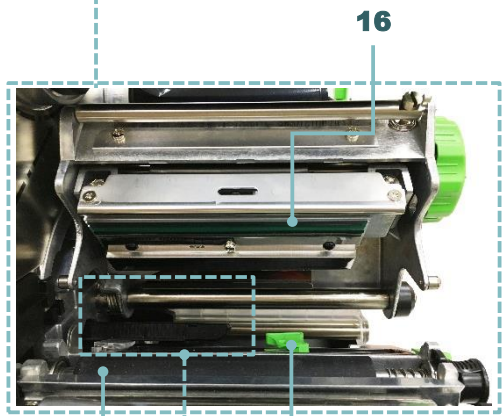

### 2.2.3 Rear View

For MH240 & MH240T Series

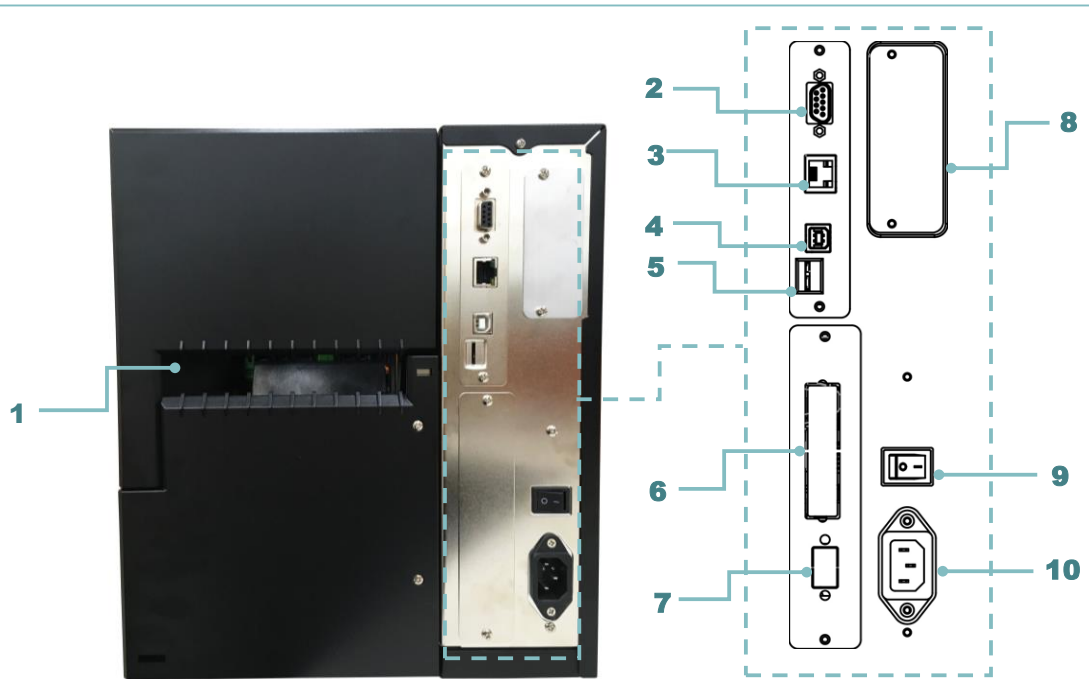

- 1.** External label entrance chute
- 2.** RS-232C interface
- 3.** Ethernet interface
- 4.** USB interface
- 5.** microSD card slot
- 6.** Centronics interface (Option)
- 7.** GPIO interface (Option)
- 8.** Slot-in Wi-Fi interface (Option)
- 9.** Power switch
- 10.** Power cord socket

**Note:**  
The interface picture here is for reference only. Please refer to the product specification for the interfaces availability.

For MH240P Series

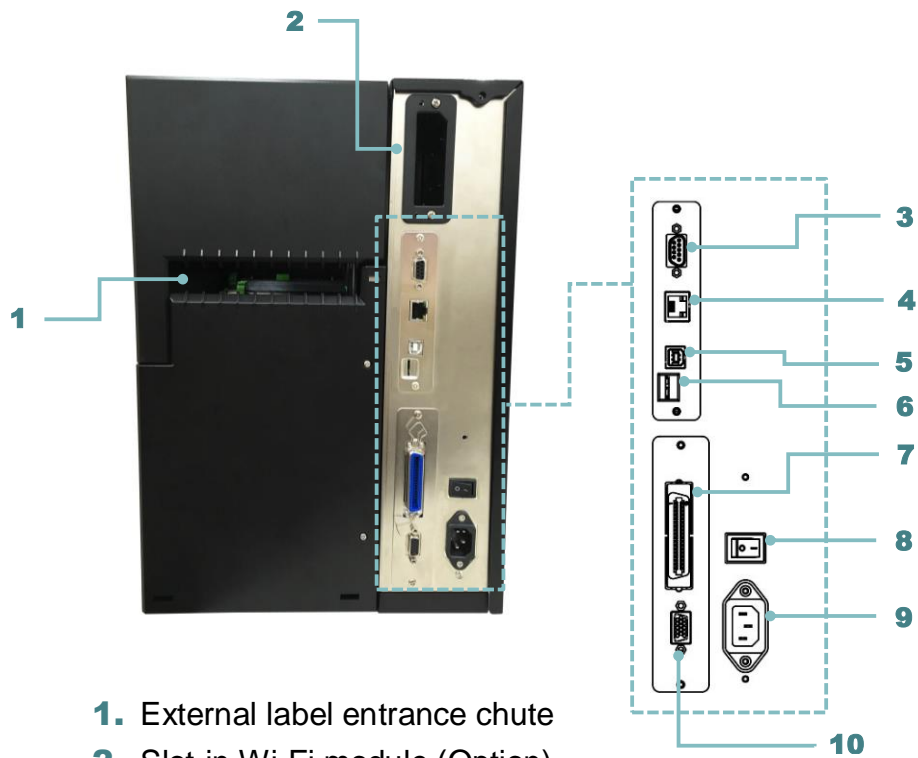

1. External label entrance chute
2. Slot-in Wi-Fi module (Option)
3. RS-232C interface
4. Ethernet interface
5. USB interface
6. microSD card slot
7. Centronics interface (Option)
8. Power switch
9. Power cord socket
10. GPIO interface (Option)

**Note:**  
The interface picture here is for reference only. Please refer to the product specification for the interfaces availability.



**\* Recommended microSD card specification.**

Type	microSD card spec	microSD card capacity	Approved microSD card manufacturer
microSD	V2.0 Class 4	4G	Transcend
	V2.0 Class 4	8G	Transcend
	V3.0 Class 10 UHS-I	16G	Transcend
	V3.0 Class 10 UHS-I	32G	Transcend
	V3.0 Class 10	16G	Kingston
	V2.0 Class 4	16G	Scandisk
	V3.0 Class 10 UHS-I	16G	Scandisk
<ul style="list-style-type: none"> <li>- The DOS FAT file system is supported for the microSD card.</li> <li>- Folders/files stored in the microSD card should be in the 8.3 filename format.</li> <li>- The miniSD / SD card adapter is required.</li> </ul>			

# 2.3 Operator Control

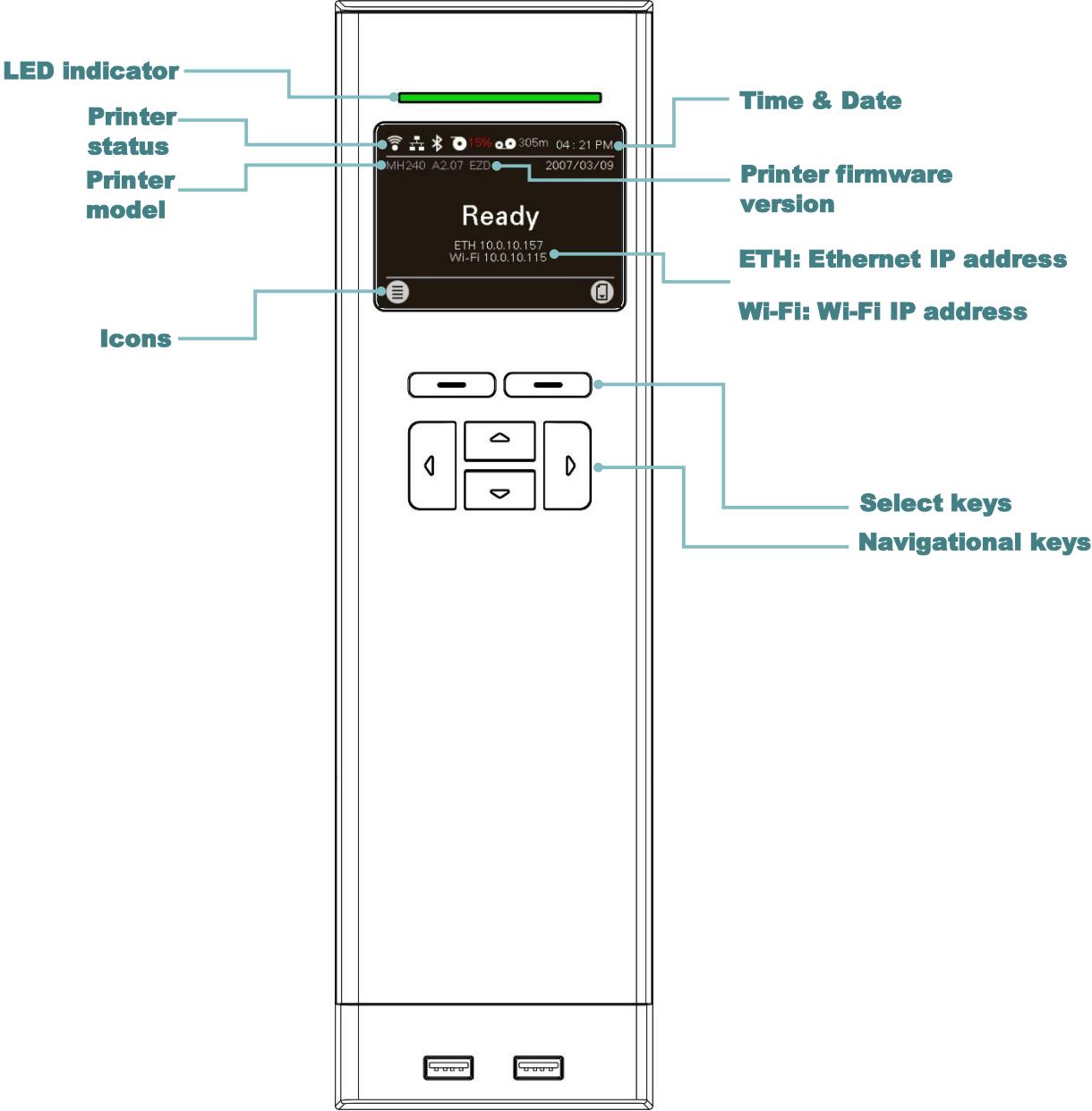

## MH240 Series



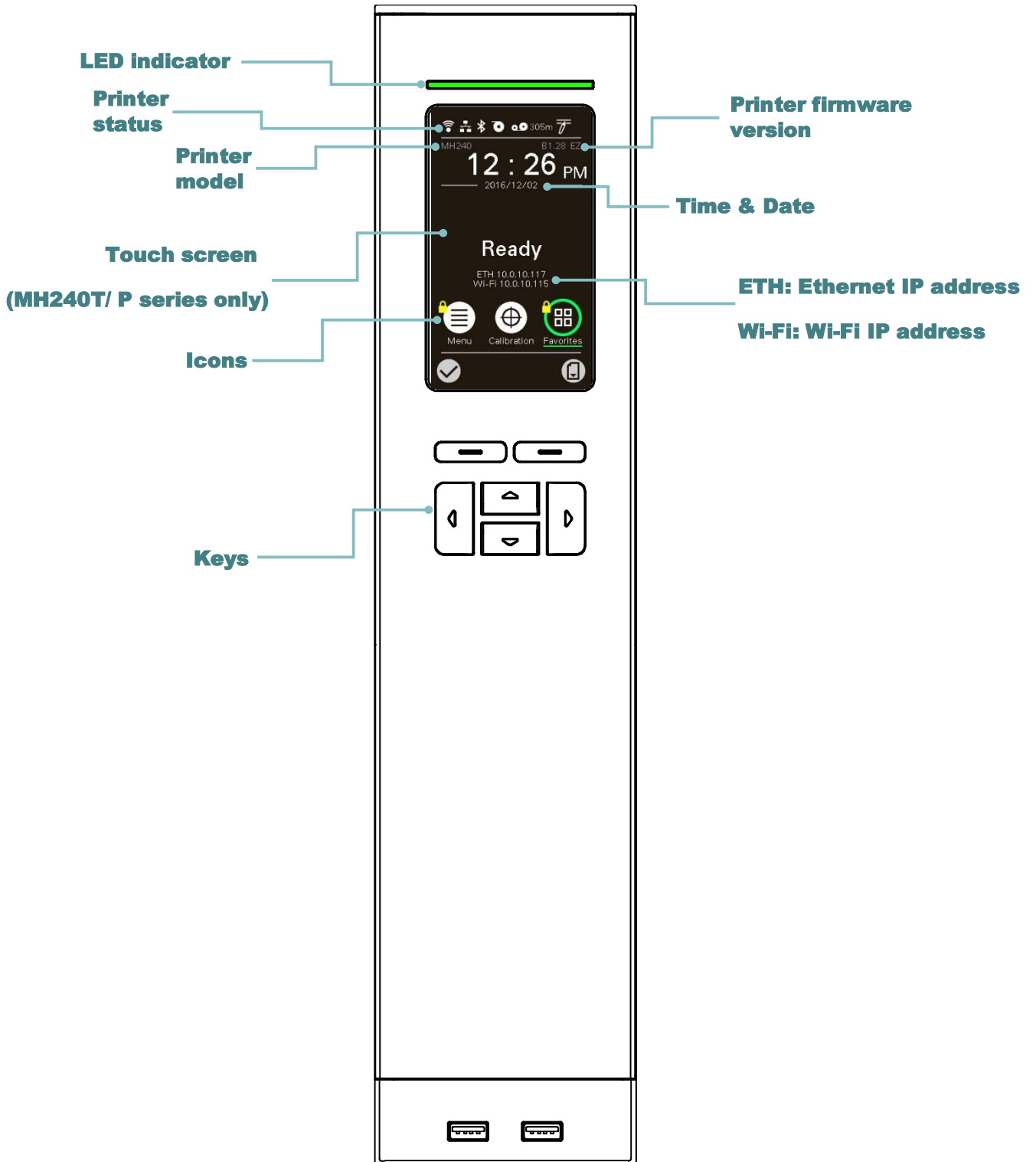





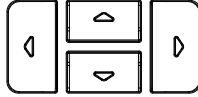





# MH240T/ MH240P Series



### 2.3.1 LED Indication and Keys

LED	Status	Indication	
	Green	Solid	This illuminates that the power is on and the device is ready to use.
		Flash	This illuminates that the system is downloading data from PC to memory or the printer is paused.
	Amber	This illuminates that the system is clearing data from printer.	
	Red	Solid	This illuminates printer head open and cutter error.
		Flash	This illuminates a printing error, such as head open, paper empty, paper jam, or memory error etc.
Keys	Function		
<p><b>Select keys</b></p> 	The labels on the footer of the UI will explain the function for left and right soft key. Check the labels on the footer of the UI screen. The meaning of the select keys will vary.		
<p><b>Navigational keys</b></p> 	Used to select icons, menu selection, and navigation in the UI.		

### 2.3.2 Main page Icons

Indicated icon	Indication
	Wi-Fi device is ready (option)
	Ethernet is connected
	Bluetooth device is ready (option)
	Media capacity (%)
	Ribbon capacity (m)
	TPH cleaning
	Security lock
Icon button	Function
	Enter the menu
	Calibrate the media sensor
	Enter the “Favorites” option (please refer to section <a href="#">6.9 (MH240 Series)</a> & <a href="#">7.9 (MH240T/MH240P Series)</a> )
	Enter cursor (be marked in green) located option
	Feed button (advance one label)

## 3. Setup

---

### 3.1 Setting up the printer

1. Place the printer on a flat, secure surface.
2. Make sure the power switch is off.
3. Connect the printer to the computer with the provided USB cable.
4. Plug the power cord into the AC power cord socket at the rear of the printer, and then plug the power cord into a properly grounded power outlet.

**Note:** Please switch OFF printer power switch prior to plug in the power cord to printer power jack.

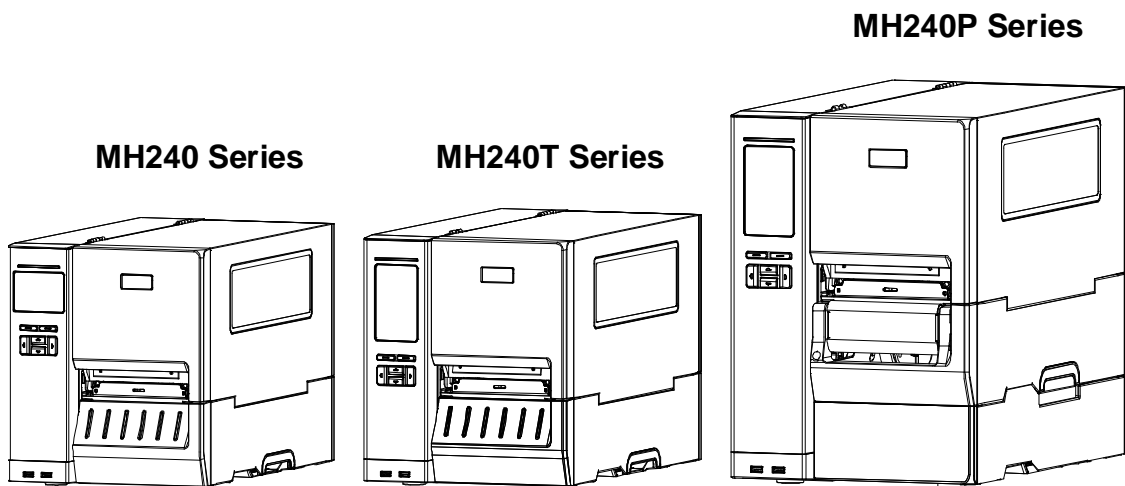

## 3.2 Loading the Ribbon



1. Open the printer right side cover.



2. Install the ribbon onto ribbon supply spindle.

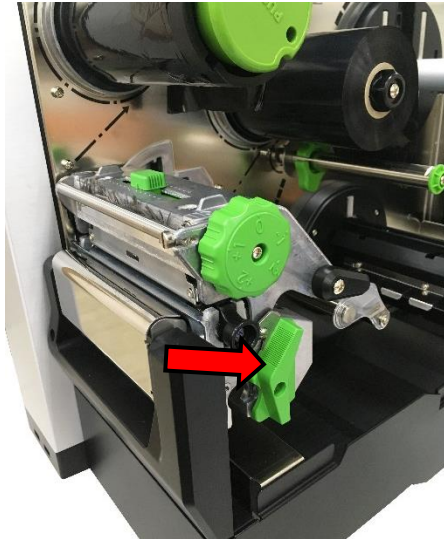

3. Push the Print head release lever to open print head mechanism.

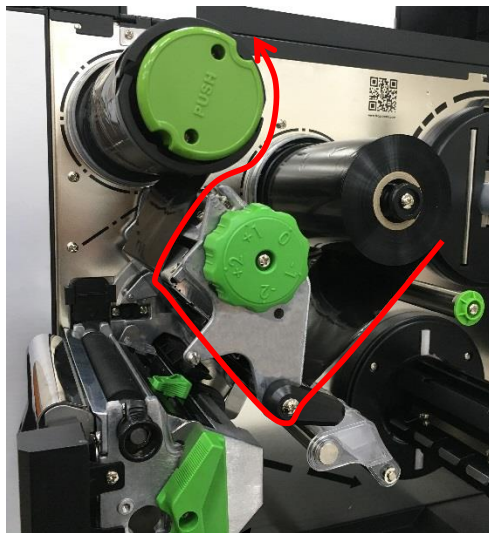

4. Thread ribbon below the ribbon guide bar through ribbon sensor slot and as the loading path printed on the printer.

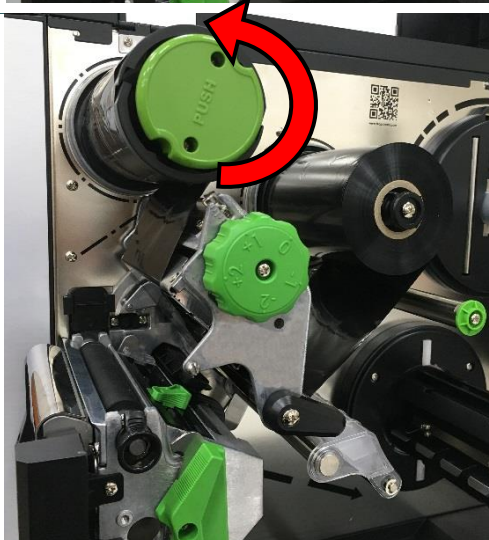

5. Wind the ribbon rewind spindle counterclockwise roughly 3-5 circles until the ribbon is smooth, properly stretched and wrinkle-free.



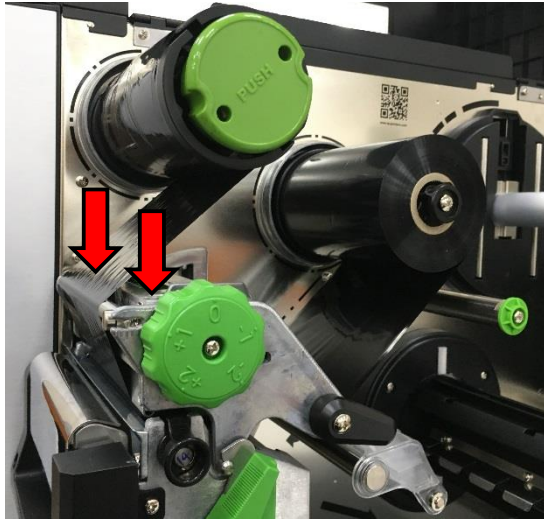

6. Close the print head mechanism by pushing down the both sides of the print head release lever.

**Note:**

\* Please refer to video on [TSC YouTube](#).

### Ribbon loading path

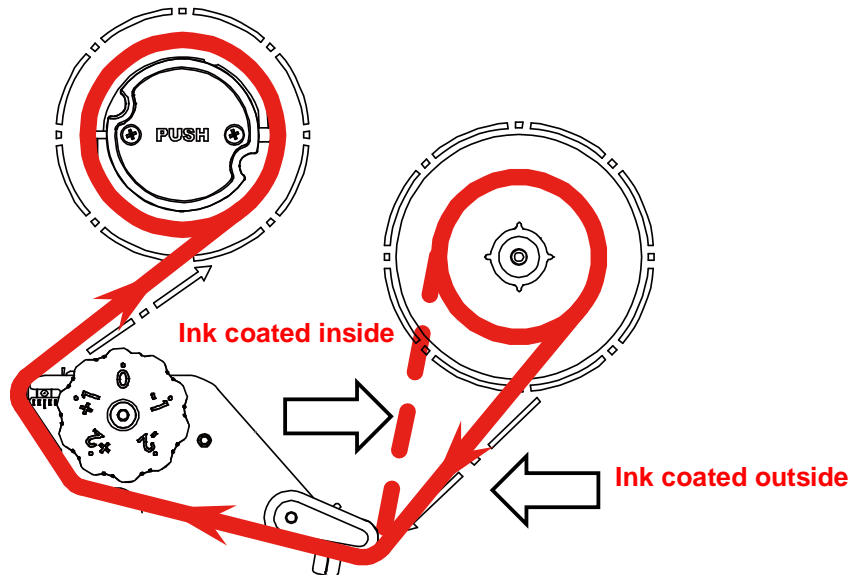

### 3.3 Remove Used Ribbon

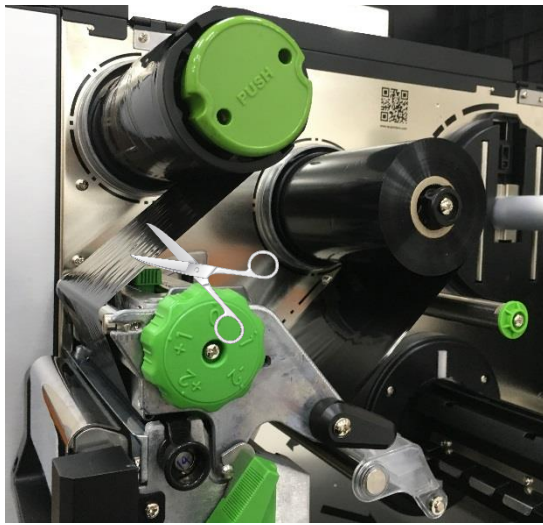

1. Break the ribbon between ribbon guide plate and the ribbon rewind spindle.

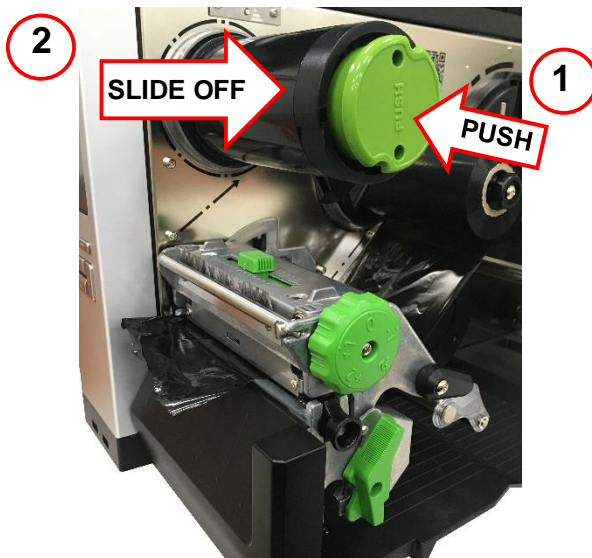

2. Push the ribbon release button and slide the ribbon off to release the ribbon on the ribbon rewind spindle at the same time.

## 3.4 Loading the Media

### 3.4.1 Loading the Media



1. Open the printer right side cover.

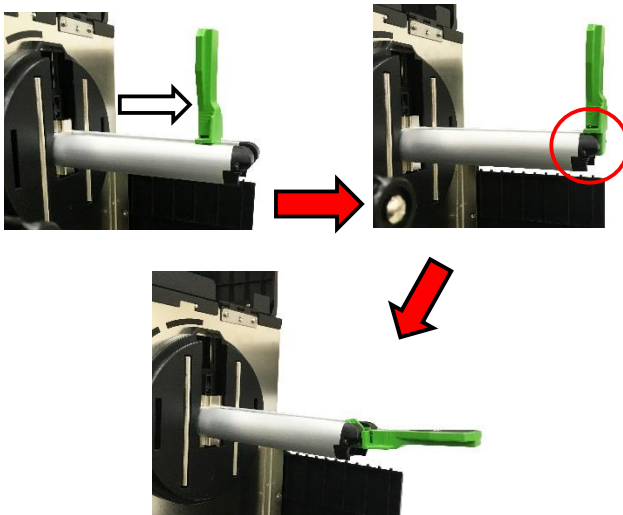

2. Move the label roll guard horizontally to the end of label spindle, then flip down the label roll guard.

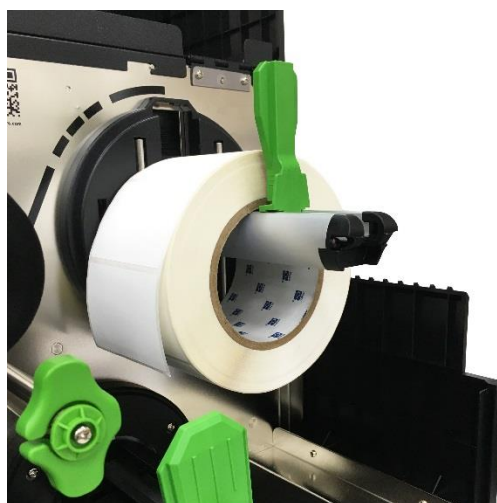

3. Place the media roll on the label supply spindle and use label roll guard to fix it.

**Note:**

The media end sensor is movable, which can detect the capacity of media and remind users to change the media roll.

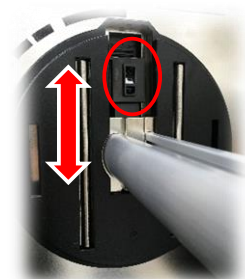

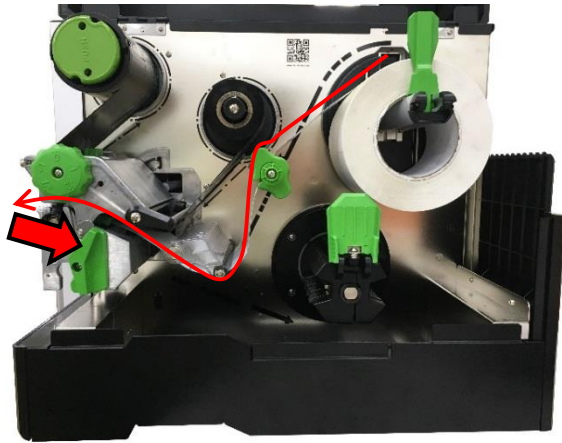

4. Push the print head release lever and install the label through the media guide bar, damper, media sensor, and label guide to install the media.

**Note: MH240 Series doesn't attach the media guide bar.**



**Interior view of MH240 Series**

5. Move the media sensor by adjusting the media sensor position adjustment knob, make sure the gap or black mark sensor is at the location where media gap/black mark will pass through for sensing.

**Black mark sensor**

(shown as ↓)

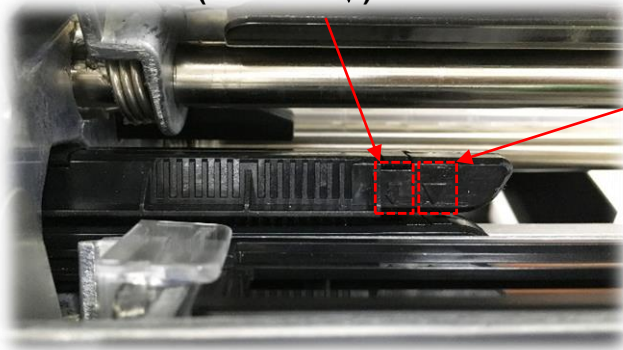

**Gap sensor**

(shown as ▽)

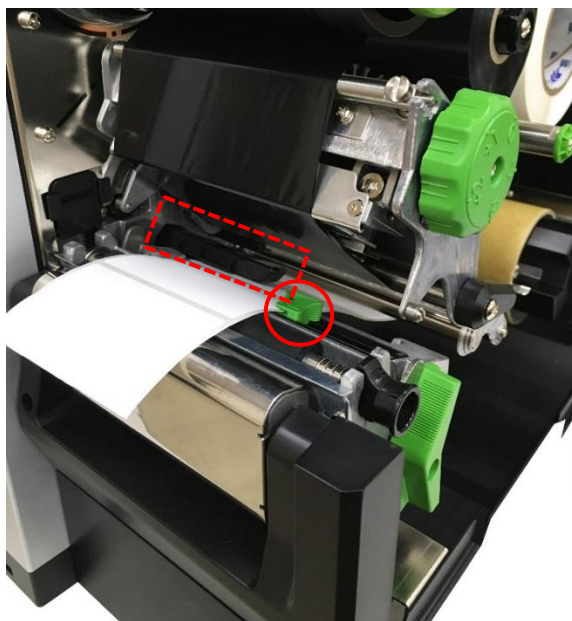

6. Adjust the label guide to fix the media position.

**Note:**

- \* Please install the media through the media sensor.
- \* The sensor location is marked by a triangle mark ▽ (gap sensor) and arrow mark ↓ (black mark sensor) at the sensor housing.
- \* The media sensor position is movable, please make sure the gap or black mark is at the location where media gap/black mark will pass through for sensing.

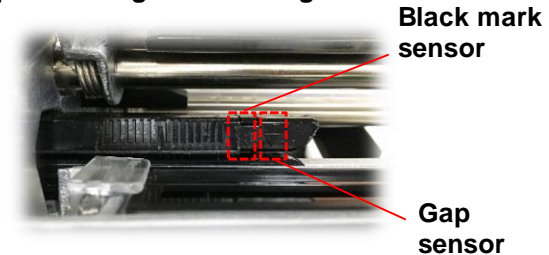

**Black mark sensor**

**Gap sensor**

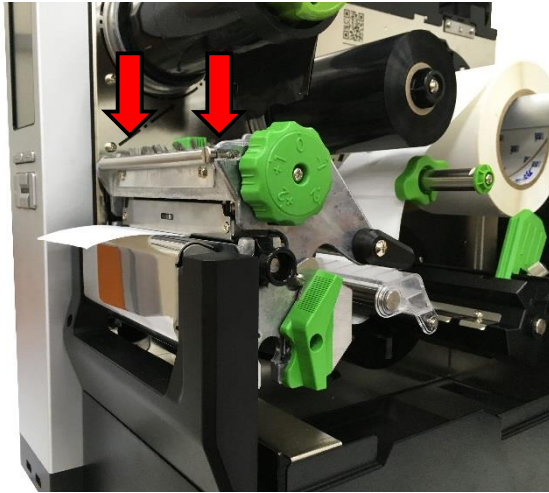

7. Close the print head mechanism on both sides and make sure the latches are engaged securely.
8. Set media sensor type and calibrate the selected sensor.

**Note:**

\* Please calibrate the gap/black mark sensor when changing media.

\* Please refer to video on [TSC YouTube](#).



### 3.4.2 Loading the Fanfold/External Media



1. Open the printer right side cover.
2. Insert the fanfold media through the bottom or rear external label entrance chute.
3. Please refer to section 3.4.1 step 4~8 for loading media.

**Note:**

**Please calibrate the gap/black mark sensor when changing media.**

#### Loading path for fan-fold labels

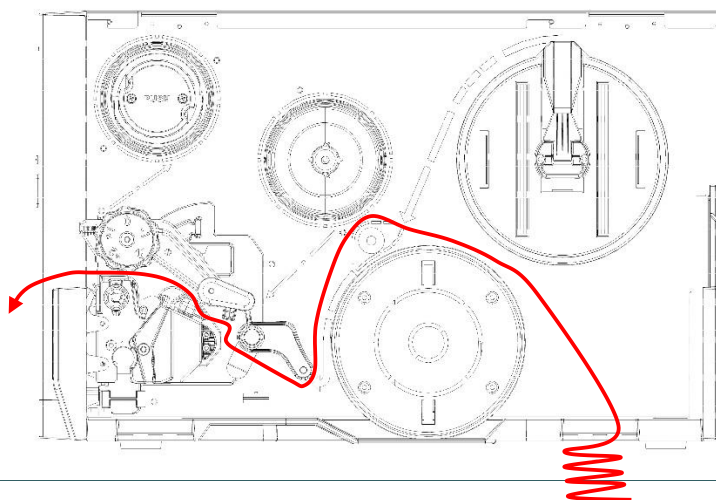
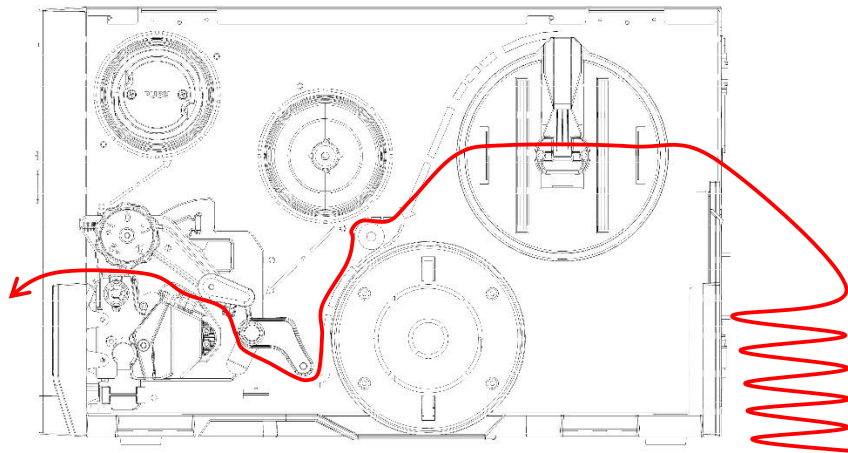

### 3.4.3 Loading Media in Peel-off Mode (Option for MH240P Series)



1. Open the printer right side cover.
2. Please refer to section 3.4.1 for loading media.
3. Using the front display panel to do the calibration first and set the printer mode to peeler mode.

**Note:**  
Please calibrate the gap/black mark sensor before loading media in the peel-off mode to avoid the paper jam.

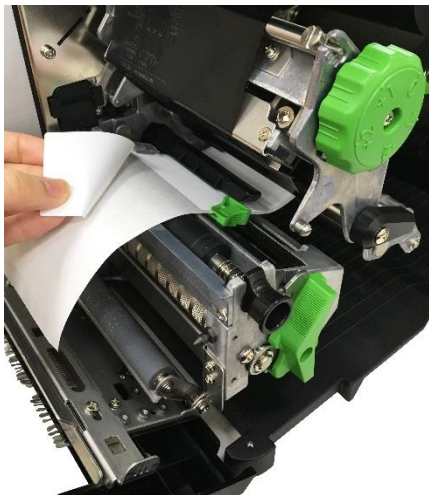

4. Open print head release lever, label guide bar release lever, and peel-off module to pull approximately 650mm of the label through the front of the printer.
5. Remove several labels to leave liner.



6. Feed the leading edge of liner through the peel-off roller.



7. Wrap the liner onto the paper core and stick the liner on the spindle. Wind the spindle until the liner stretched properly.



8. Close print head release lever and using the front display panel to set the print mode to "Peel off".
9. Press the FEED button to test.



### 3.4.4 Loading Media in Rewind Mode (Option for MH240P Series)



1. Open the printer right side cover.
2. Please refer to section 3.4.1 for loading media.
3. Using the front display panel to do the calibration and set the printer mode to rewind mode.



4. Open the printer lower cover, then push the label guide to the far right side and pull it down.

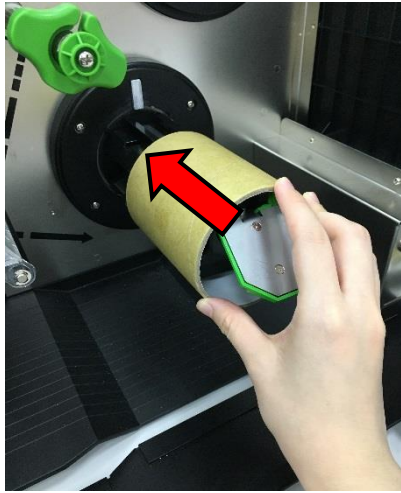

5. Install the paper core onto the rewind spindle.



6. Open print head release lever and label guide bar release lever to pull approximately 650mm of the label through the front of the printer.  
7. Feed the leading edge of media through the redirect front panel as picture shown.



8. Wrap the label onto the internal rewind spindle and stick the label onto the paper core. Wind the spindle counterclockwise until the label stretched properly.

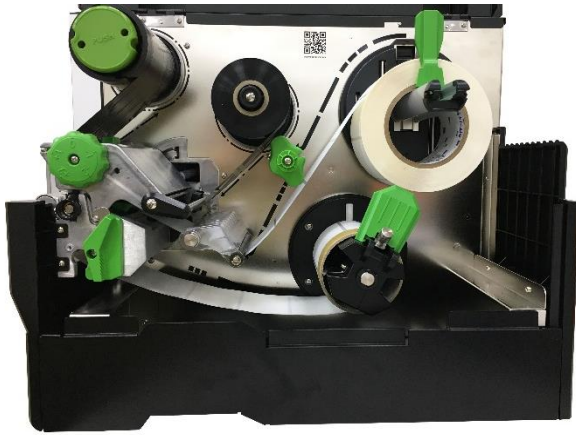
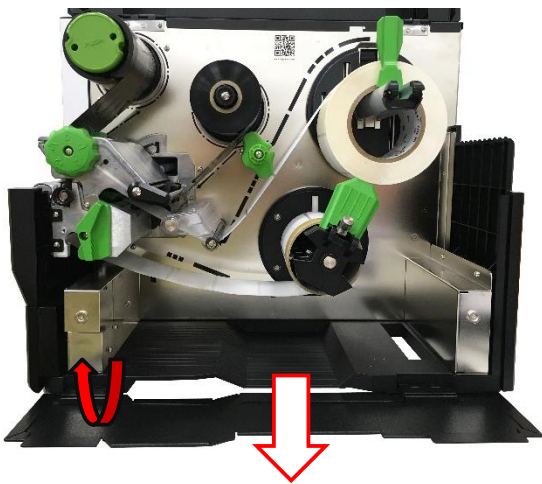

9. Adjust the media rewind guide to fit the label width.
10. Close print head release lever and print head lower cover.

## 4. Adjustment Knob

### 4.1 Print Head Pressure Adjustment Knob & Print Head Pressure Position Adjustment Knob

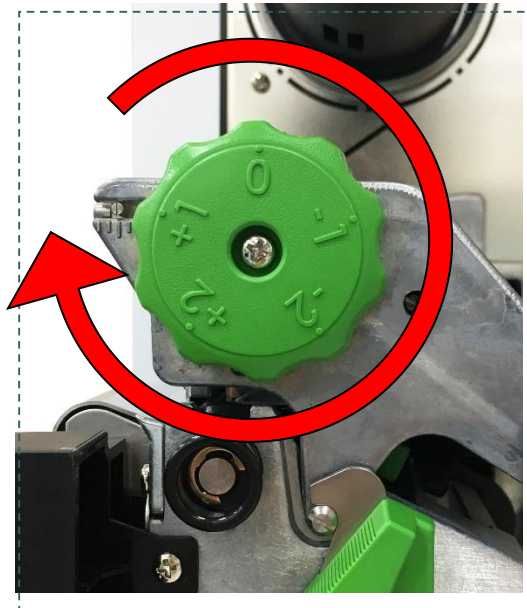

The print head pressure adjustment knob has 5 levels of adjustment. Because the printer's paper alignment is to the left side of mechanism, different media widths require the different pressure to print the label correctly. Therefore, it may require to adjust the print head pressure adjustment knob and get the best print quality.

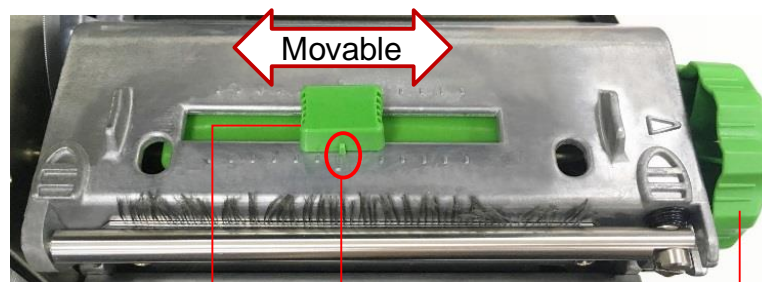

Print head pressure  
position adjustment knob

Default setting

Print head pressure  
adjustment knob

Note:

For the label width less than 2 inches, please fix the **Print head pressure adjustment knob** inside the edge of the label as possible (prevent the unnecessary friction between the print head and platen roller).

### 4.2 Ribbon Tension Adjustment Knob Module

The ribbon tension adjustment knob has 5 positions for adjustment. Because the printer's ribbon alignment is to the left side of mechanism, different ribbon or media widths require different tension to print correctly. Therefore, it may require to adjust the ribbon tension adjustment knob to get your best print quality.

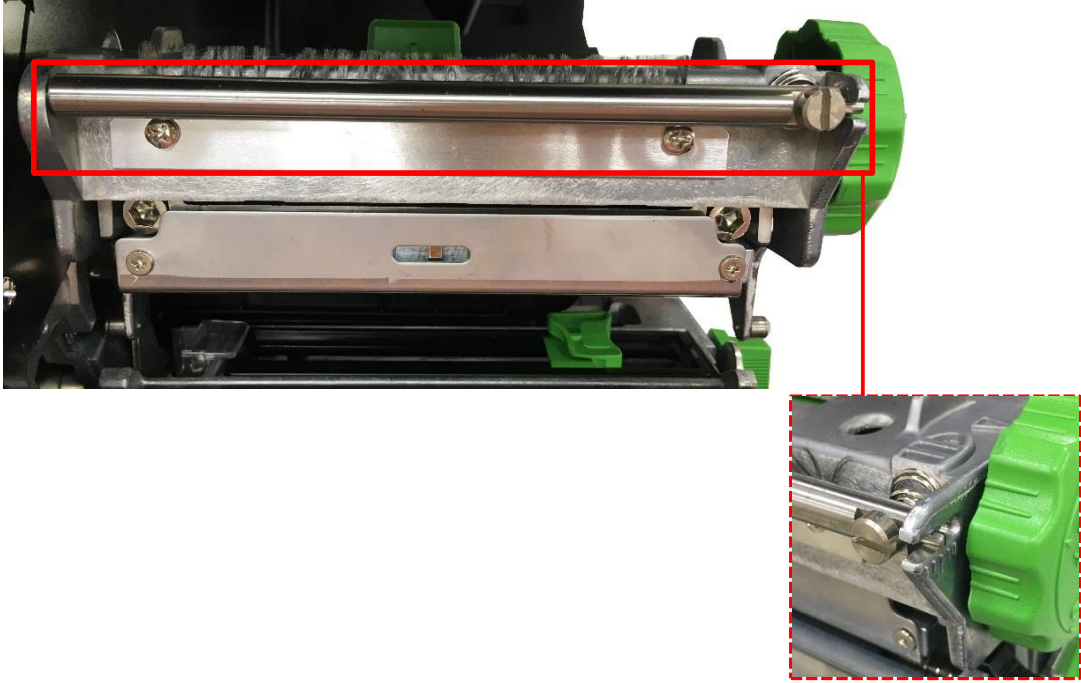







Ribbon Tension Adjustment Knob

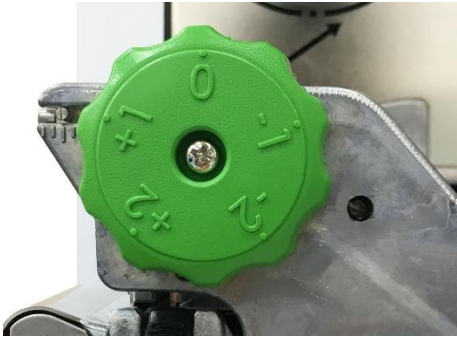
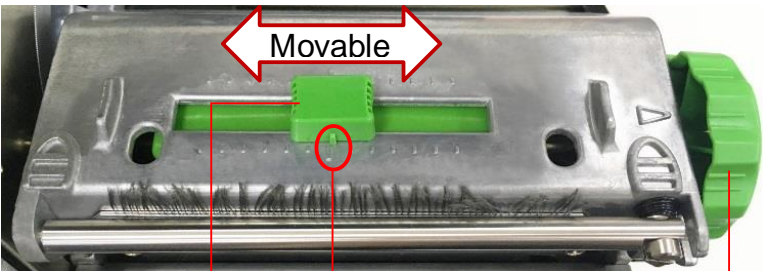

### 4.3 Mechanism Fine Adjustment to Avoid Ribbon Wrinkles

This printer has been fully tested before delivery. There should be no ribbon wrinkle presented on the media for general-purpose printing application. Ribbon wrinkle is related to the media width, thickness, print head pressure balance, ribbon film characteristics, print darkness setting...etc. In case the ribbon wrinkle happens, please follow the instructions below to adjust the printer parts.



<p><b>Adjustable Printer Parts</b></p>	<p>Ribbon Tension Adjustment Knob has 5 positions for adjustment. Use flat blade driver to change the ribbon tension position.</p>  <p>Ribbon Tension Adjustment Knob</p>
	<p>The Print Head Pressure Adjustment Knob has 5 levels of settings. Switch the Print head Pressure Adjustment Knob and cooperate with the Print Head Pressure Position Adjustment Knob to adjust the pressure and position on print head.</p>  <p>Print Head Pressure Adjustment Knob</p>
	 <p>Print head pressure position adjustment knob      <b>Default setting</b>      Print head pressure adjustment knob</p>

Symptom	1. Wrinkle happens from label lower left to upper right direction (“ ’ ”)	2. Wrinkle happens from label lower right to upper left direction (“ ` ”)
		
<p data-bbox="263 1167 375 1234"><b>Wrinkle Example</b></p>	<p data-bbox="422 840 861 929">If the wrinkle on the label starts from the lower left side to upper right side, please do following adjustment.</p> <ol data-bbox="422 958 853 1081" style="list-style-type: none"> <li>1. Switch the ribbon tension adjustment knob clockwise per 1 level and print the label again to check if the wrinkle is gone.</li> </ol>  <ol data-bbox="422 1494 885 1977" style="list-style-type: none"> <li>2. If the ribbon tension adjustment knob has positioned on the level of innermost side but didn't improve the ribbon wrinkle, please switch the print head pressure position adjustment knob per 1 level and print the label again to check if the wrinkle is gone.</li> <li>3. If the ribbon wrinkle still can't improve after switch the print head pressure position adjustment knob, please adjust the print head pressure adjustment knob per 1 level again to check if the wrinkle is gone.</li> </ol>	<p data-bbox="901 840 1340 929">If the wrinkle on the label starts from the lower right side to upper left side, please do following adjustment.</p> <ol data-bbox="901 958 1332 1111" style="list-style-type: none"> <li>1. Switch the ribbon tension adjustment knob counterclockwise per 1 level and print the label again to check if the wrinkle is gone.</li> </ol>  <ol data-bbox="901 1525 1364 2067" style="list-style-type: none"> <li>2. If the ribbon tension adjustment knob has positioned on the level of outermost side but didn't improve the ribbon wrinkle, please switch the print head pressure position adjustment knob per 1 level and print the label again to check if the wrinkle is gone.</li> <li>3. If the ribbon wrinkle still can't improve after switch the print head pressure position adjustment knob, please adjust the print head pressure adjustment knob per 1 level again to check if the wrinkle is gone.</li> </ol>
	 <p data-bbox="842 589 959 685"><b>Feed direction</b></p>	

## 5. Diagnostic Tool

TSC's Diagnostic Utility is an integrated tool incorporating features that enable you to explore a printer's settings/status; change a printer's settings; download graphics, fonts, and firmware; create a printer bitmap font; and send additional commands to a printer. With the aid of this powerful tool, you can review printer status and setting in an instant, which makes it much easier to troubleshoot problems and other issues.

### 5.1 Start the Diagnostic Tool

1. Double click on the Diagnostic tool icon   to start the software.
2. There are four features (Printer Configuration, File Manager, Bitmap Font Manager, Command Tool) included in the Diagnostic utility.

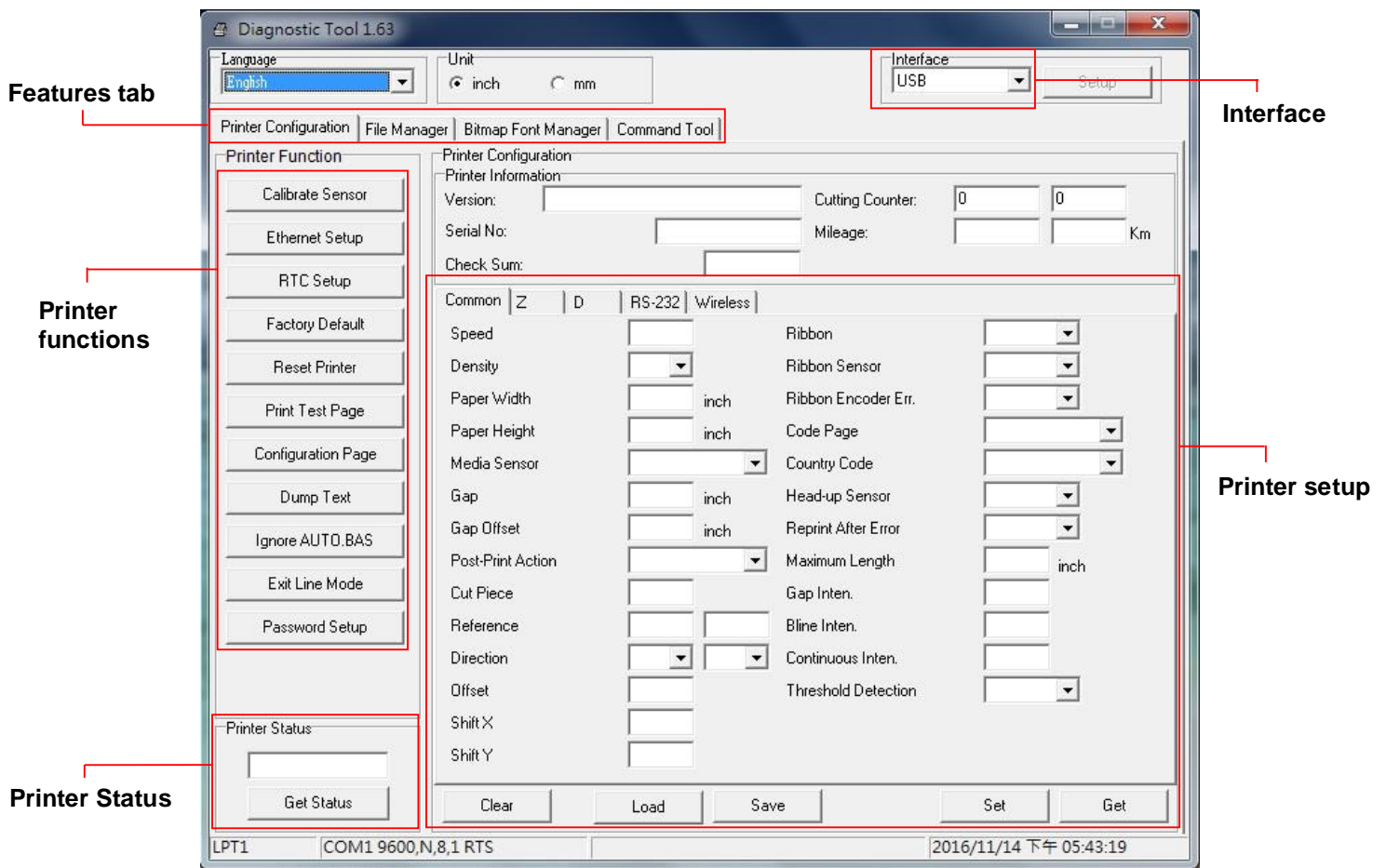



## 5.2 Printer Function

1. Connect the printer and computer with a cable.
2. Select the PC interface connected with bar code printer.

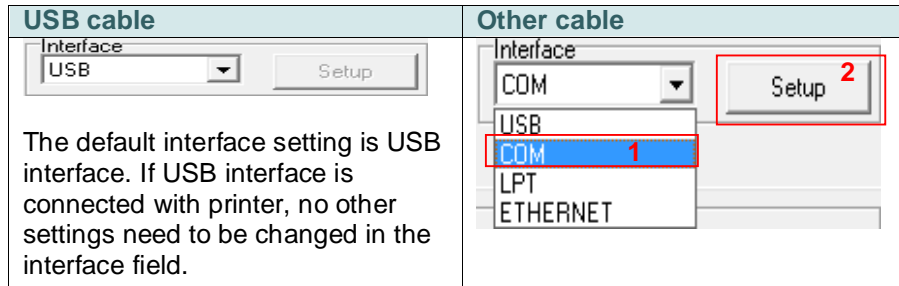

3. Click the “Printer Function” button to setup.
4. The detail functions in the Printer Function Group are listed as below.

Printer Function	Function	Description
Calibrate Sensor	Calibrate Sensor	Calibrate the sensor specified in the Printer Setup group media sensor field
Ethernet Setup	Ethernet Setup	Setup the IP address, subnet mask, gateway for the on board Ethernet
RTC Setup	RTC Setup	Synchronize printer Real Time Clock with PC
Factory Default	Factory Default	Initialize the printer and restore the settings to factory default.
Reset Printer	Reset Printer	Reboot printer
Print Test Page	Print Test Page	Print a test page
Configuration Page	Configuration Page	Print printer configuration
Dump Text	Dump Text	To activate the printer dump mode.
Ignore AUTO.BAS	Ignore AUTO.BAS	Ignore the downloaded AUTO.BAS program
Exit Line Mode	Exit Line Mode	Exit line mode.
Password Setup	Password Setup	Set the password to protect the settings

**For more information about Diagnostic Tool, please refer to the diagnostic utility quick start guide in TSC official website Downloads \ Manuals \ Utilities \ Diagnostic utility quick start guide.**

## 5.3 Setting Ethernet by Diagnostic Tool

The Diagnostic Utility is enclosed in the CD disk \ Utilities directory. Users can use Diagnostic Tool to setup the Ethernet by RS-232, USB and Ethernet interfaces. The following contents will instruct users how to configure the Ethernet by these three interfaces.

### 5.3.1 Using USB interface to setup Ethernet interface

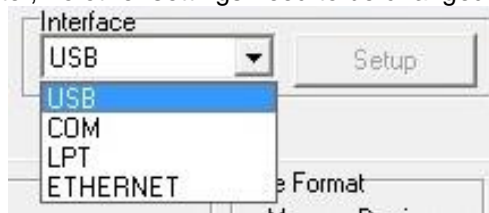

1. Connect the printer and computer with USB cable.
2. Turn on the printer power switch.
3. Start the Diagnostic Utility by double clicking on the  icon.
4. The Diagnostic Utility default interface setting is USB interface. If USB interface is connected with printer, no other settings need to be changed in the interface field.

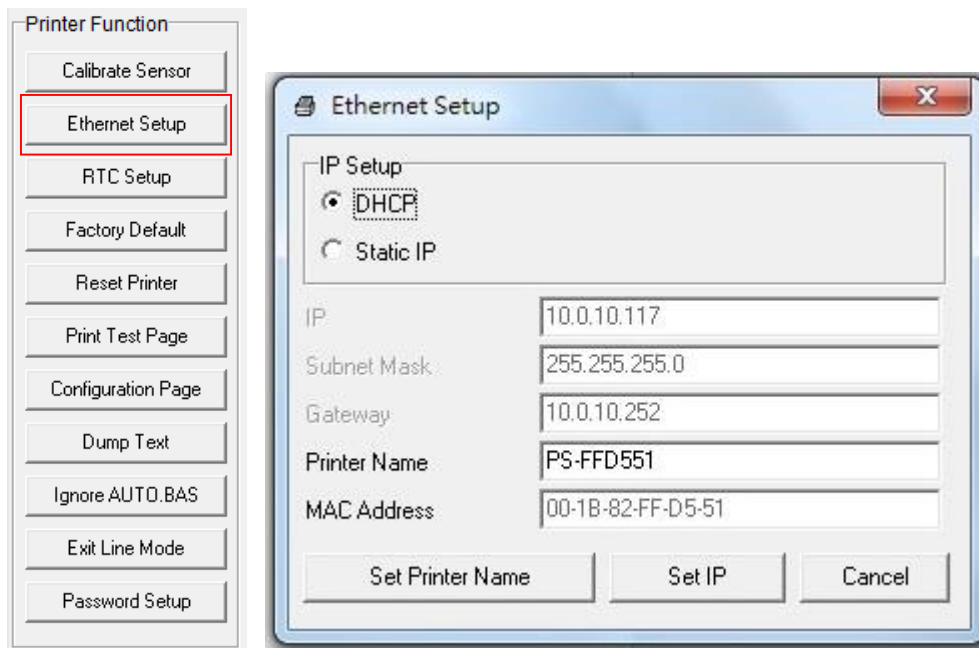

5. Click on the “Ethernet Setup” button from “Printer Function” group in Printer Configuration tab to setup the IP address, subnet mask and gateway for the on board Ethernet.



### 5.3.2 Using RS-232 interface to setup Ethernet interface

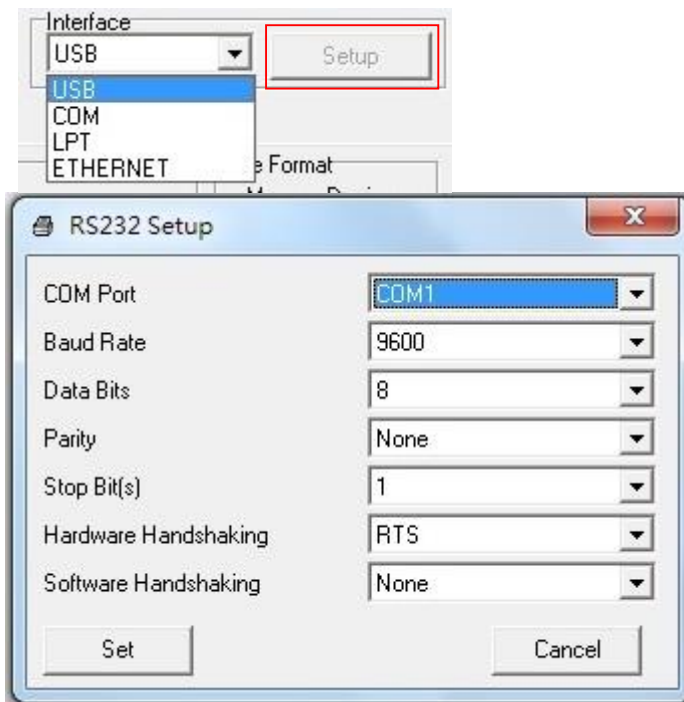

1. Connect the computer and the printer with a RS-232 cable.
2. Turn on the printer power.
3. Start the Diagnostic Utility by double clicks on the  **DiagTool.exe** icon.
4. Select “COM” as interface then click on the  **“Setup”** button to setup the serial port baud rate, parity check, data bits, stop bit and flow control parameters.

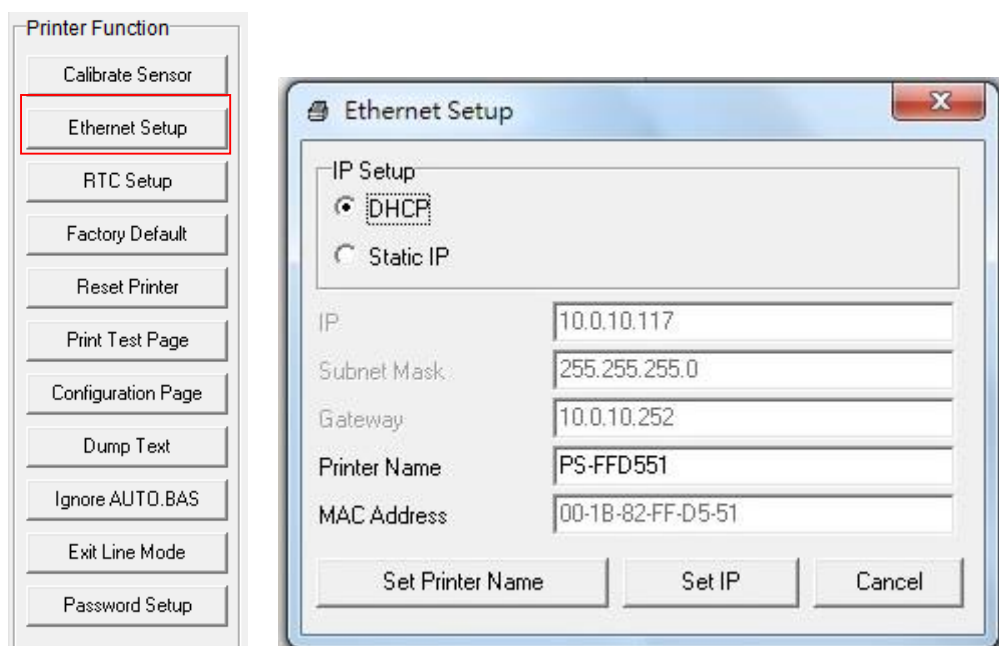

5. Click on the “Ethernet Setup” button from printer function of Printer Configuration tab to setup the IP address, subnet mask and the gateway for the on board Ethernet.



### 5.3.3 Using Ethernet interface to setup Ethernet interface

1. Connect the computer and the printer to the LAN.
2. Turn on the printer power.
3. Start the Diagnostic Utility by double clicks on the   icon.
4. Select “Ethernet” as the interface then click on the “Setup” button to setup the IP address, subnet mask and gateway for the on board Ethernet.

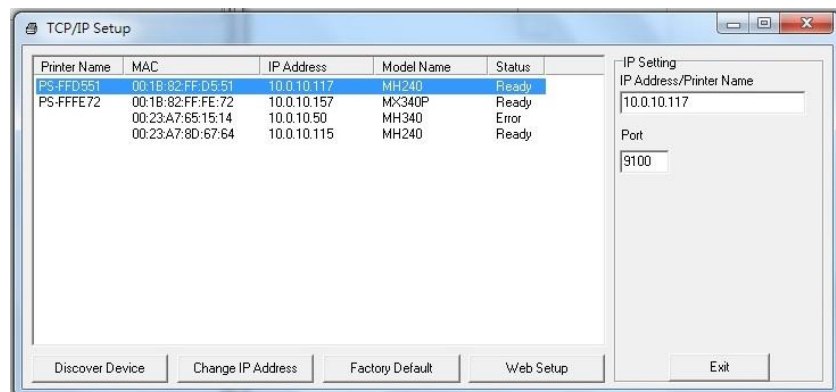
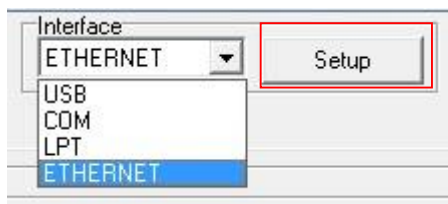

5. Click the “Discover Device” button to explore the printers that exist on the network.
6. Select the printer in the left side of listed printers, the correspondent IP address will be shown in the right side “IP address/Printer Name” field.
7. Click “Change IP Address” to configure the IP address obtained by DHCP or static.

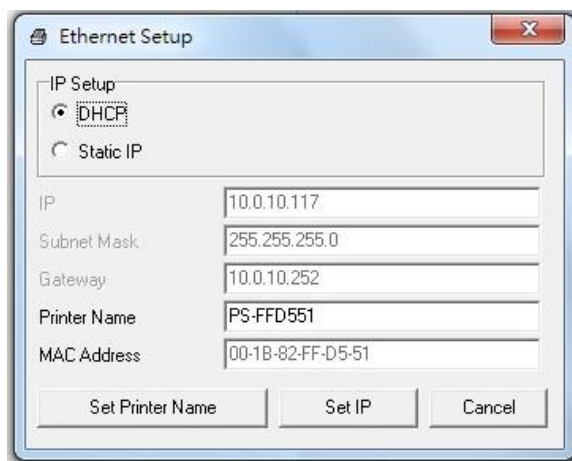

The default IP address is obtained by DHCP. To change the setting to static IP address, click “Static IP” radio button then enter the IP address, subnet mask and gateway. Click “Set IP” to take effect the settings.

Users can also change the “Printer Name” by another model name in this field then click “Set Printer Name” to take effect this change.

**Note: After clicking the “Set Printer Name” or “Set IP” button, printer will reset to take effect the settings.**

8. Click "Exit" button to exit the Ethernet interface setup and go back to Diagnostic Tool main screen.

#### "Factory Default" button

This function will reset the IP, subnet mask, gateway parameters obtained by DHCP and reset the printer name.

#### "Web setup" button



Except to use the Diagnostic Utility to setup the printer, you can also explore and configure the printer settings and status or update the firmware with the IE or Firefox web browser. This feature provides a user friendly setup interface and the capability to manage the printer remotely over a network.

# 6. LCD Menu Function for MH240 Series

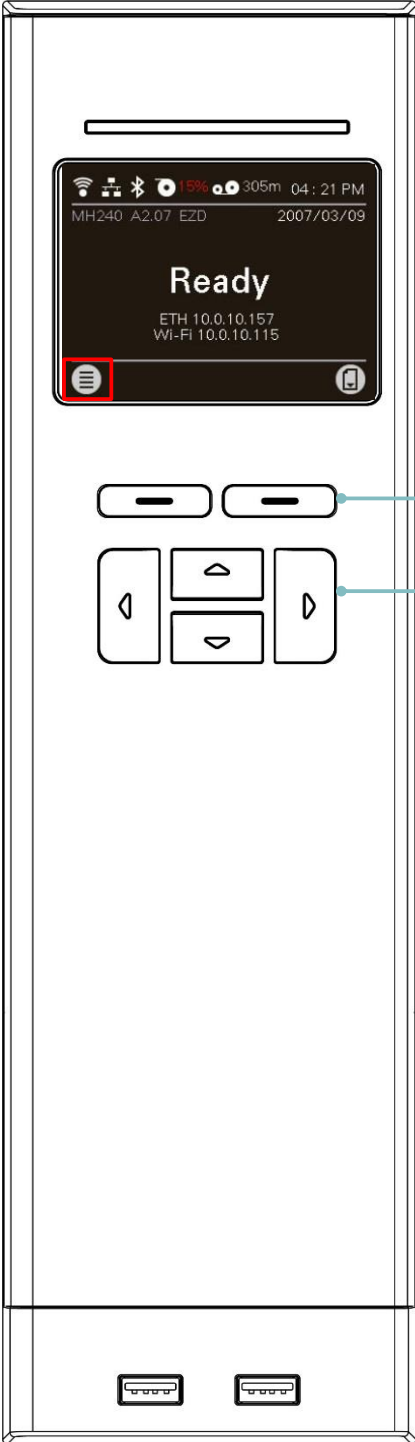
## 6.1 Enter the Menu



**\* By Keys:**

Use Select keys to select the  "Menu" icon and press the right select key button (means  ) to enter each function.

**Select keys**  
**Navigational keys**

## 6.2 Menu Overview

There are 6 categories for the menu. You can easily set the settings of the printer without connecting the computer. Please refer to following sections for more details.



This "Setting" category can set up the printer settings for TSPL & ZPL2.



This "Sensor" option is used to calibrate the selected media sensor. We recommend calibrate the sensor before printing when changing the media.

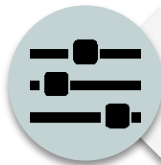

This "Interface" option is used to set the printer interface settings.

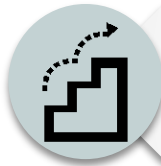

This "Advanced" option is used to set the printer LCD settings, initialization, cutter type, media low warning setting %...etc.



This "File Manager" option is used to check/manager the printer available memory.



This "Diagnostic" option is used to review printer to troubleshoot problems and other issues.

## 6.3 Setting

Choose the “Command Set” item on LCD and switch the TSPL and ZPL2 by press right select key.

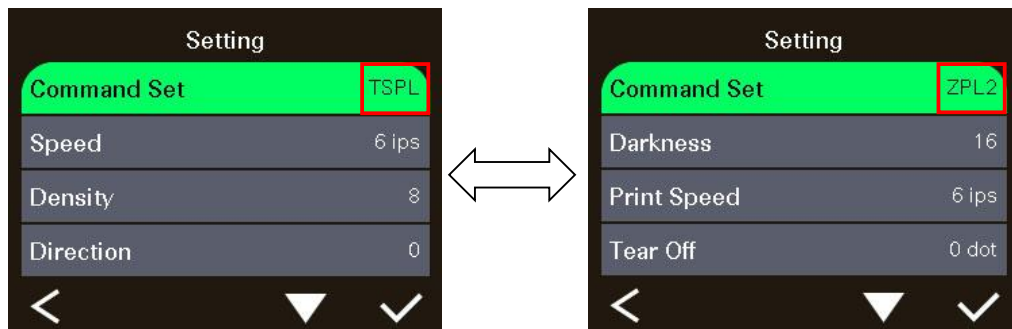

### 6.3.1 TSPL

This “TSPL” category can set up the printer settings for TSPL.

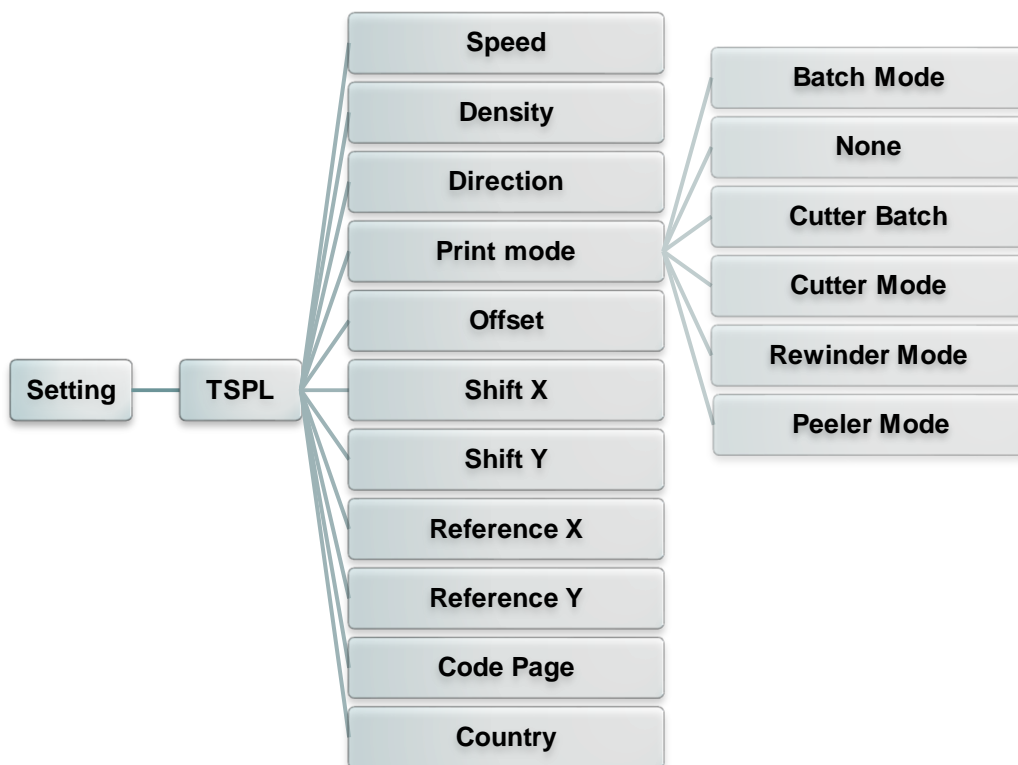

Item	Description	Default
<b>Speed</b>	Use this item to setup print speed. Available setting range is 2~14 for 203dpi, 2~12 for 300dpi and 1~6 for 600dpi.	203 dpi: 6 300 dpi: 4 600 dpi: 3
<b>Density</b>	Use this option to setup printing darkness. The available setting range is from 0 to 15, and the step is 1. You may need to adjust your density based on selected media.	8



<b>Direction</b>	<p>The direction setting value is either 1 or 0. Use this item to setup the printout direction.</p> <table border="1" style="width: 100%; text-align: center;"> <tr> <td style="width: 50%;">DIRECTION 0</td> <td style="width: 50%;">DIRECTION 1</td> </tr> <tr> <td style="border: 1px solid black; padding: 10px;">Direction</td> <td style="border: 1px solid black; padding: 10px;">Direction</td> </tr> </table>	DIRECTION 0	DIRECTION 1	Direction	Direction	<b>0</b>										
DIRECTION 0	DIRECTION 1															
Direction	Direction															
<b>Print mode</b>	<p>This item is used to set the print mode. There are 6 modes as below,</p> <table border="1" style="width: 100%; border-collapse: collapse;"> <thead> <tr> <th style="width: 20%;">Printer Mode</th> <th>Description</th> </tr> </thead> <tbody> <tr> <td>None</td> <td>Next label top of form is aligned to the print head burn line location. (Tear Off Mode)</td> </tr> <tr> <td>Cutter Batch</td> <td>Cut the label once at the end of the printing job.</td> </tr> <tr> <td>Cutter Mode</td> <td>Enable the label cutter mode.</td> </tr> <tr> <td>Rewinder Mode</td> <td>Enable the label rewinder mode.</td> </tr> <tr> <td>Peeler Mode</td> <td>Enable the label peel off mode.</td> </tr> <tr> <td>Batch Mode</td> <td>Once image is printed completely, label gap/black mark will be fed to the tear plate location for tear away.</td> </tr> </tbody> </table>	Printer Mode	Description	None	Next label top of form is aligned to the print head burn line location. (Tear Off Mode)	Cutter Batch	Cut the label once at the end of the printing job.	Cutter Mode	Enable the label cutter mode.	Rewinder Mode	Enable the label rewinder mode.	Peeler Mode	Enable the label peel off mode.	Batch Mode	Once image is printed completely, label gap/black mark will be fed to the tear plate location for tear away.	<b>Batch Mode</b>
Printer Mode	Description															
None	Next label top of form is aligned to the print head burn line location. (Tear Off Mode)															
Cutter Batch	Cut the label once at the end of the printing job.															
Cutter Mode	Enable the label cutter mode.															
Rewinder Mode	Enable the label rewinder mode.															
Peeler Mode	Enable the label peel off mode.															
Batch Mode	Once image is printed completely, label gap/black mark will be fed to the tear plate location for tear away.															
<b>Offset</b>	This item is used to fine tune media stop location. Available setting value range is from -999 dots to 999 dots.	<b>0 dot</b>														
<b>Shift X</b>	This item is used to fine tune print position. Available setting value range is from -999 dots to 999 dots.	<b>0 dot</b>														
<b>Shift Y</b>		<b>0 dot</b>														
<b>Reference X</b>	This item is used to set the origin of printer coordinate system horizontally and vertically. Available setting range is from 0 dot to 999 dots.	<b>0 dot</b>														
<b>Reference Y</b>		<b>0 dot</b>														
<b>Code page</b>	Use this item to set the code page of international character set.	<b>950</b>														
<b>Country</b>	Use this option to set the country code. Available setting value range is from 1 to 358.	<b>001</b>														

**Note: If printing from enclosed software/driver, the software/driver will send out the commands, which will overwrite the settings set from the panel.**

### 6.3.2 ZPL2

This “ZPL2” category can set up the printer settings for ZPL2.

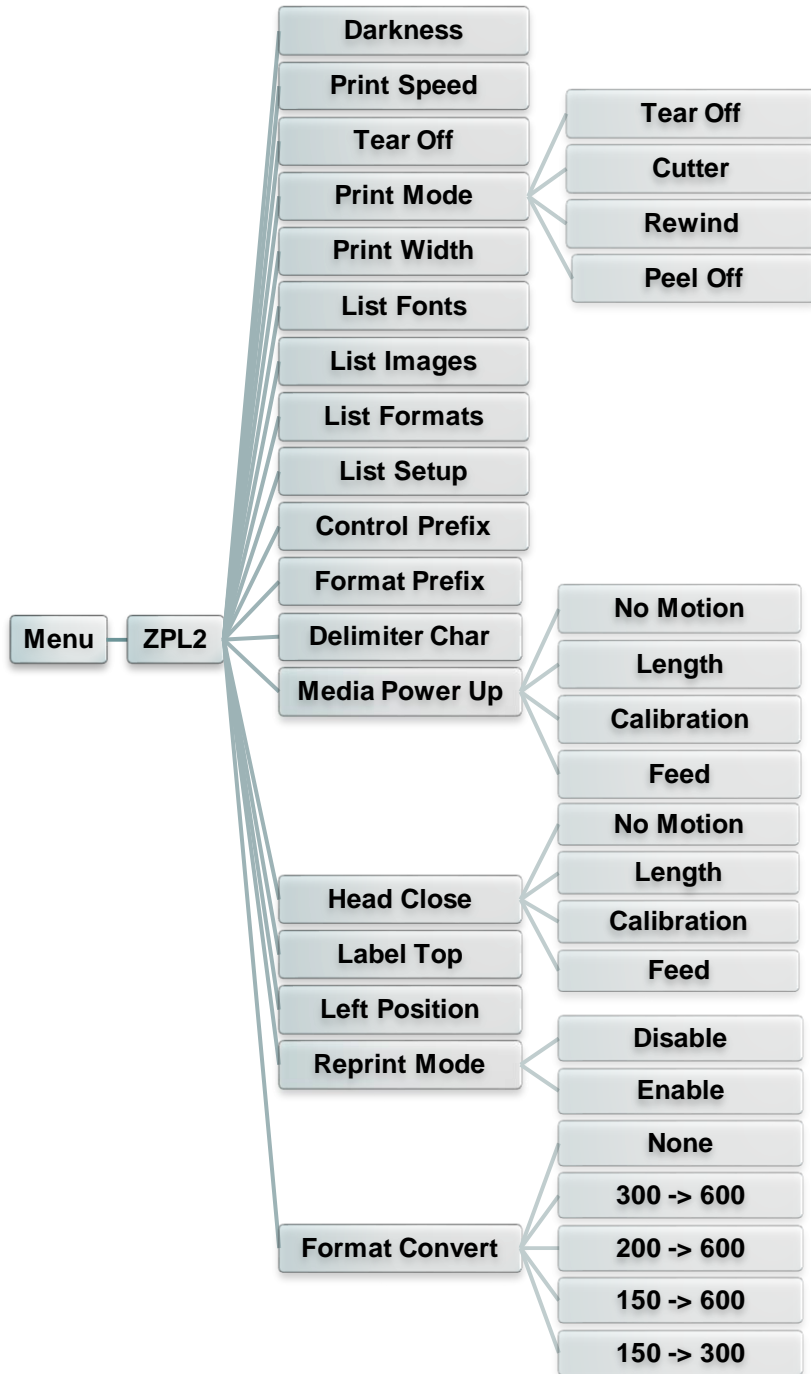

Item	Description	Default
<b>Density</b>	Use this item to setup printing darkness. The available setting range is from 0 to 30. You may need to adjust your density based on selected media.	<b>16</b>
<b>Print Speed</b>	Use this item to setup print speed. Available setting range is 2~18 for 203dpi, 2~14 for 300dpi and 1.5 ~6 for 600dpi.	<b>203 dpi: 6 300 dpi: 4 600 dpi: 3</b>

<b>Tear Off</b>	This item is used to fine tune media stop location. Available setting value range is from -120~120 dots.	<b>0 dot</b>										
<b>Print mode</b>	<p>This item is used to set the print mode. There are 3 modes as below,</p> <table border="1"> <thead> <tr> <th>Printer Mode</th> <th>Description</th> </tr> </thead> <tbody> <tr> <td>Tear Off</td> <td>Next label top of form is aligned to the print head burn line location.</td> </tr> <tr> <td>Peel Off</td> <td>Enable the label peel off mode.</td> </tr> <tr> <td>Cutter</td> <td>Enable the label cutter mode</td> </tr> <tr> <td>Rewind</td> <td>Enable the label rewind mode</td> </tr> </tbody> </table>	Printer Mode	Description	Tear Off	Next label top of form is aligned to the print head burn line location.	Peel Off	Enable the label peel off mode.	Cutter	Enable the label cutter mode	Rewind	Enable the label rewind mode	<b>Tear Off</b>
Printer Mode	Description											
Tear Off	Next label top of form is aligned to the print head burn line location.											
Peel Off	Enable the label peel off mode.											
Cutter	Enable the label cutter mode											
Rewind	Enable the label rewind mode											
<b>Print Width</b>	This item is used to set print width. The available value range is 2 ~ 999 dots.	<b>812</b>										
<b>List Fonts</b>	This feature is used to print current printer available fonts list to the label. The fonts stored in the printer's DRAM, Flash or optional memory card.	<b>N/A</b>										
<b>List Images</b>	This feature is used to print current printer available images list to the label. The images stored in the printer's DRAM, Flash or optional memory card.	<b>N/A</b>										
<b>List Formats</b>	This feature is used to print current printer available formats list to the label. The formats stored in the printer's DRAM, Flash or optional memory card.	<b>N/A</b>										
<b>List Setup</b>	This feature is used to print current printer configuration to the label.	<b>N/A</b>										
<b>Control Prefix</b>	This feature is used to set control prefix character.	<b>N/A</b>										
<b>Format Prefix</b>	This feature is used to set format prefix character.	<b>N/A</b>										
<b>Delimiter Char</b>	This feature is used to set delimiter character.	<b>N/A</b>										
<b>Media Power Up</b>	<p>This option is used to set the action of the media when you turn on the printer.</p> <table border="1"> <thead> <tr> <th>Selections</th> <th>Description</th> </tr> </thead> <tbody> <tr> <td>Feed</td> <td>Printer will advance one label</td> </tr> <tr> <td>Calibration</td> <td>Printer will calibration the sensor levels, determine length and feed label</td> </tr> <tr> <td>Length</td> <td>Printer determine length and feed label</td> </tr> <tr> <td>No Motion</td> <td>Printer will not move media</td> </tr> </tbody> </table>	Selections	Description	Feed	Printer will advance one label	Calibration	Printer will calibration the sensor levels, determine length and feed label	Length	Printer determine length and feed label	No Motion	Printer will not move media	<b>No Motion</b>
Selections	Description											
Feed	Printer will advance one label											
Calibration	Printer will calibration the sensor levels, determine length and feed label											
Length	Printer determine length and feed label											
No Motion	Printer will not move media											
<b>Head Close</b>	<p>This option is used to set the action of the media when you close the print head.</p> <table border="1"> <thead> <tr> <th>Selections</th> <th>Description</th> </tr> </thead> <tbody> <tr> <td>Feed</td> <td>Printer will advance one label</td> </tr> <tr> <td>Calibration</td> <td>Printer will calibration the sensor levels, determine length and feed label</td> </tr> <tr> <td>Length</td> <td>Printer determine length and feed label</td> </tr> <tr> <td>No Motion</td> <td>Printer will not move media</td> </tr> </tbody> </table>	Selections	Description	Feed	Printer will advance one label	Calibration	Printer will calibration the sensor levels, determine length and feed label	Length	Printer determine length and feed label	No Motion	Printer will not move media	<b>No Motion</b>
Selections	Description											
Feed	Printer will advance one label											
Calibration	Printer will calibration the sensor levels, determine length and feed label											
Length	Printer determine length and feed label											
No Motion	Printer will not move media											
<b>Label Top</b>	This option is used to adjust print position vertically on the label. The range is -120 to +120 dots.	<b>0</b>										
<b>Left Position</b>	This option is used to adjust print position horizontally on the label. The range is -9999 to +9999 dots.	<b>0</b>										

<b>Reprint Mode</b>	When reprint mode is enabled, you can reprint the last label printer by pressing  button on printer's control panel.	<b>Disable</b>
<b>Format Convert</b>	Selects the bitmap scaling factor. The first number is the original dots per inch (dpi) value; the second, the dpi to which you would like to scale.	<b>None</b>

***Note: If printing from enclosed software/driver, the software/driver will send out the commands, which will overwrite the settings set from the panel.***

## 6.4 Sensor

This option is used to calibrate the selected sensor. We recommend calibrate the sensor before printing when changing the media.

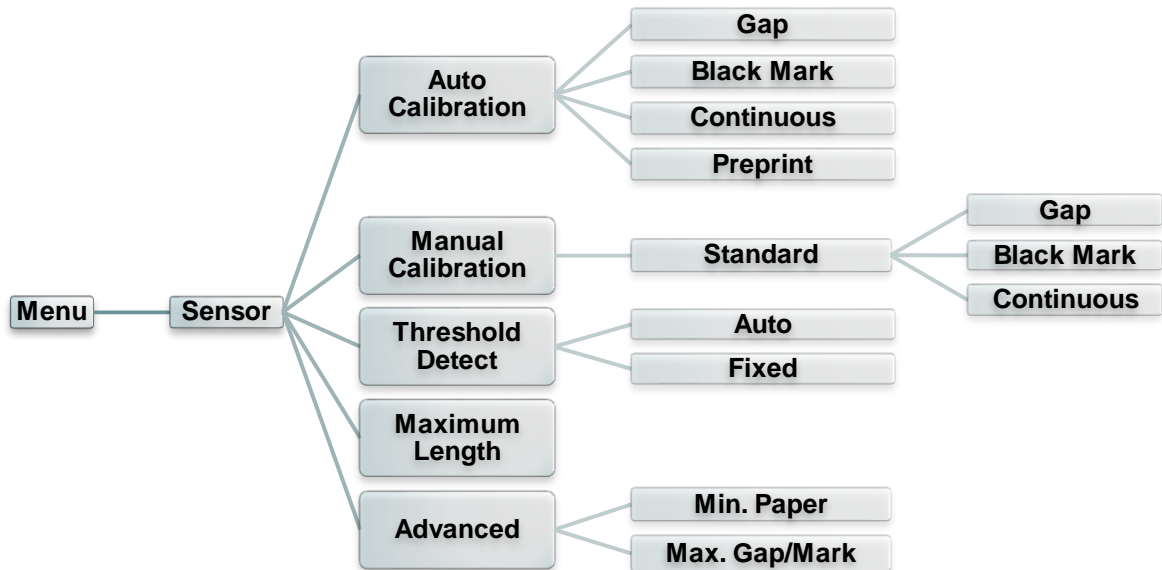

Item	Description	Default
<b>Auto Calibration</b>	This option is used to set the media sensor type and calibrate the selected sensor automatically. Printer will feed 2 to 3 gap labels to calibrate the sensor sensitivity automatically.	<b>N/A</b>
<b>Manual setup</b>	In case “Automatic” cannot apply to the media, please use “Manual” function to set the paper length and gap/bline size then scan the backing/mark to calibrate the sensor sensitivity.  <b>Note: The “Media Capacity” item is used to calibrate the media capacity sensor %.</b>	<b>N/A</b>
<b>Threshold Detect</b>	This option is used to set sensor sensitivity in fixed or auto.	<b>Auto</b>
<b>Maximum Length</b>	This option is used to set the maximum length for label calibration.	<b>254 mm</b>
<b>Advanced</b>	This function can set the minimum paper length and maximum gap/bline length for auto-calibrate the sensor sensitivity.	<b>0 mm</b>

## 6.5 Interface

This option is used to set the printer interface settings.

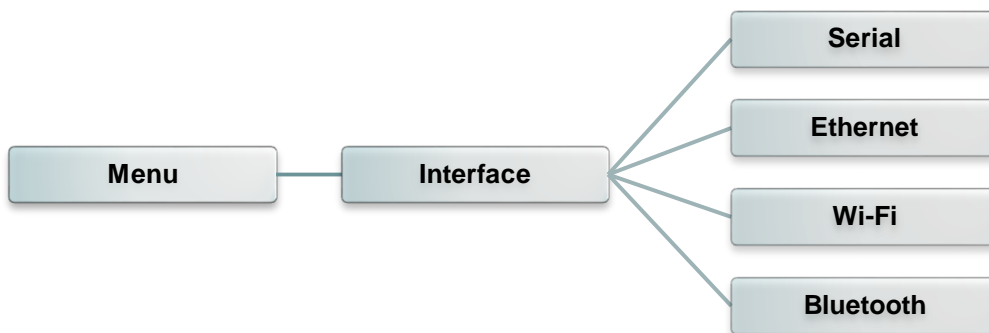

### 6.5.1 Serial Comm.

This option is used to set the printer RS-232 settings.

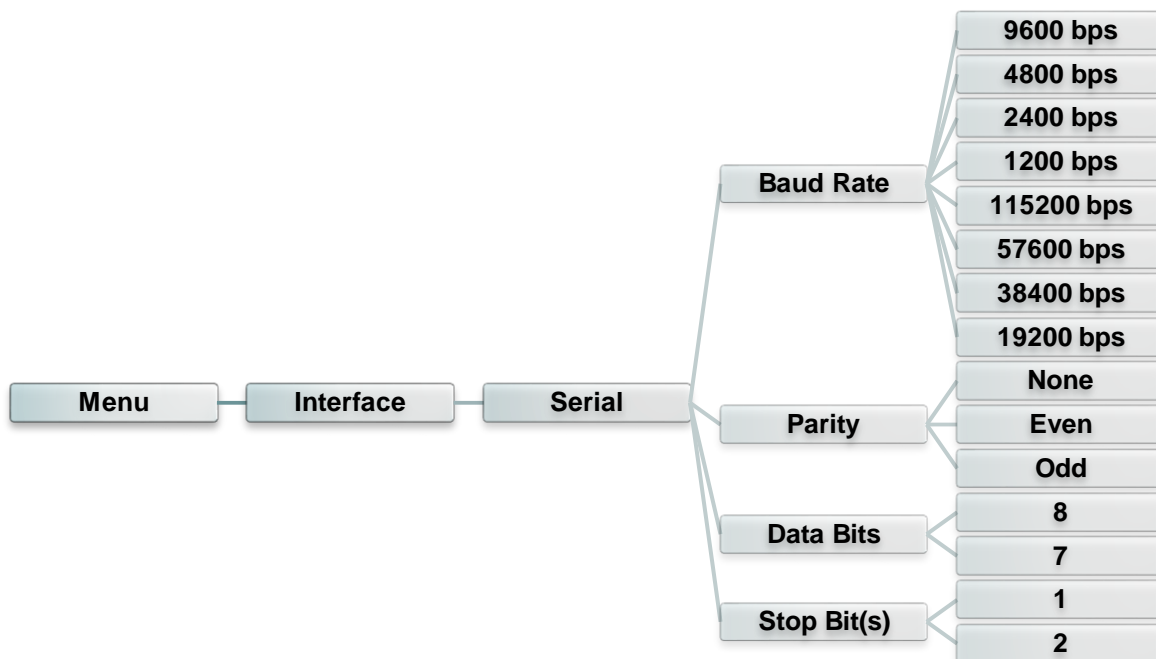

Item	Description	Default
<b>Baud Rate</b>	This item is used to set the RS-232 baud rate.	<b>9600</b>
<b>Parity</b>	This item is used to set the RS-232 parity.	<b>None</b>
<b>Data Bits</b>	This item is used to set the RS-232 Data Bits.	<b>8</b>
<b>Stop Bit(s)</b>	This item is used to set the RS-232 Stop Bits.	<b>1</b>

## 6.5.2 Ethernet

Use this menu to configure internal Ethernet configuration, check the printer's Ethernet module status, and reset the Ethernet module.

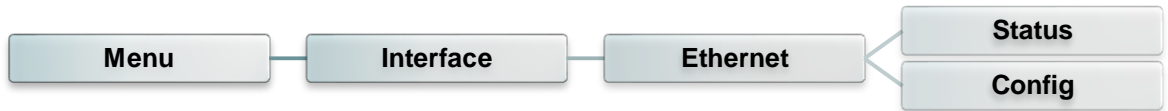

Item	Description	Default
Status	Use this menu to check the Ethernet IP address and MAC setting status.	N/A
Config.	<b>DHCP:</b> This item is used to ON or OFF the DHCP (Dynamic Host Configuration Protocol) network protocol. <b>Static IP:</b> Use this menu to set the printer's IP address, subnet mask and gateway.	DHCP

### 6.5.3 Wi-Fi

This option is used to set the printer Wi-Fi settings.

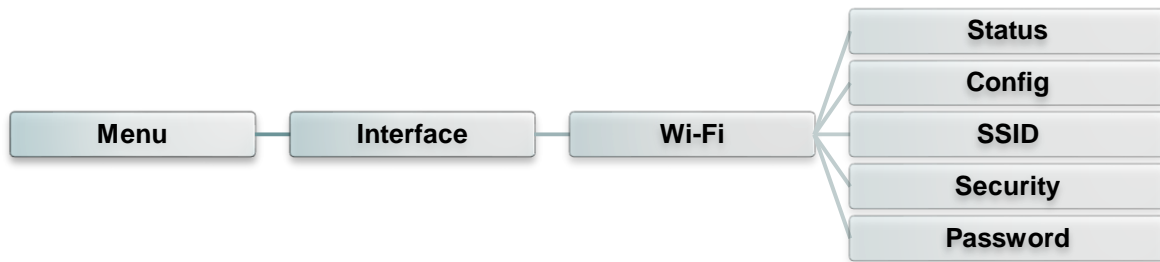

Item	Description	Default
<b>Status</b>	Use this menu to check the Wi-Fi IP address, MAC setting status....	<b>N/A</b>
<b>Config.</b>	<b>DHCP:</b> This item is used to ON or OFF the DHCP (Dynamic Host Configuration Protocol) network protocol. <b>Static IP:</b> Use this menu to set the printer's IP address, subnet mask and gateway.	<b>DHCP</b>
<b>SSID</b>	Use this menu to set the Wi-Fi SSID	<b>N/A</b>
<b>Security</b>	Use this menu to set the Wi-Fi security	<b>Open</b>
<b>Password</b>	Use this menu to set the Wi-Fi password	<b>N/A</b>

### 6.5.4 Bluetooth

This option is used to set the printer Bluetooth settings.

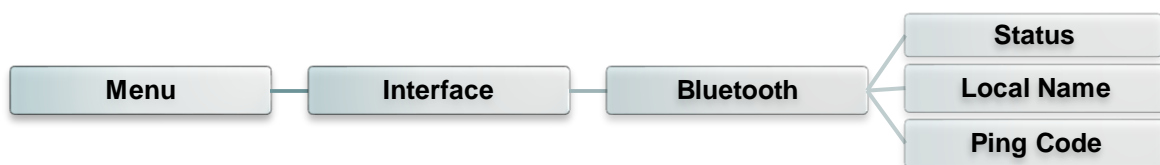

Item	Description	Default
<b>Status</b>	Use this menu to check the Bluetooth status.	<b>N/A</b>
<b>Local Name</b>	This item is used to set the local name for Bluetooth.	<b>RF-BHS</b>
<b>Ping Code</b>	This item is used to set the local ping code for Bluetooth.	<b>0000</b>



## 6.6 Advanced

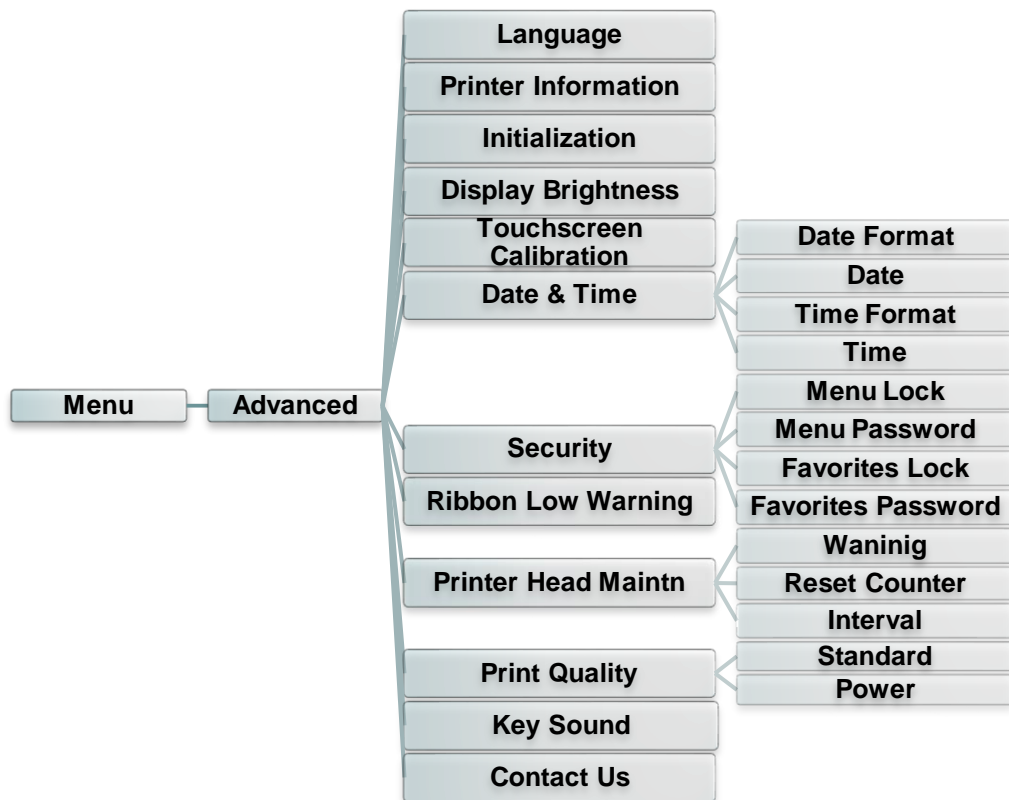

Item	Description	Default
<b>Language</b>	This item is used to setup the language on display.	<b>English</b>
<b>Printer Information</b>	This feature is used to check the printer serial number, printed mileage (m), printed labels (pcs) and cutting counter.	<b>N/A</b>
<b>Initialization</b>	This feature is used to restore printer settings to defaults.	<b>N/A</b>
<b>Display Brightness</b>	This item is used to setup the brightness for display. (Range 0~100)	<b>50</b>
<b>Touchscreen Calibration</b>	This item is used to calibrate the center of the cross for best result for touchscreen.	<b>N/A</b>
<b>Date &amp; Time</b>	This item is used to setup the date and time on display.	<b>N/A</b>
<b>Security</b>	This feature is used to set the password for locking the menu or favorites. The default password is 8888.	<b>Disable</b>
<b>Ribbon Low Warning</b>	This item is used to set the warning for ribbon low. For example, if setting value is 30m, when ribbon capacity was lower than 30m, the  will be shown in red.	<b>30m</b>

<b>Printer Head Maintn</b>	This item is used to check print head status and to set the settings for print head care.		<b>N/A</b>
	<b>Item</b>	<b>Description</b>	
	Warning	This item is used to enable/disable the print head clean warning. If enable this feature, once print head has been reached the setting mileage then the warning icon will be shown on printer UI for reminding user to clean the print head. The default setting is disable.	
	Reset Counter	This item is used to reset the print head clean warning mileage after cleaned print head.	
	Interval	This item is used to set the expected mileage for reminding user to clean the print head. You have to enable the "TPH warning lock" for use. The default setting is 1 km.	
<b>Print Quality</b>	This item is used to select the print quality to standard/ power mode.		<b>Standard</b>
<b>Key Sound</b>	This item is used to open/close the key sound.		<b>ON</b>
<b>Contact us</b>	This feature is used to check the contact information for tech support service		<b>N/A</b>

# 6.7 File Manager

This feature is used to check the printer available memory, show the files list, delete the files or run the files that saved in the printer DRAM/Flash/Card memory.

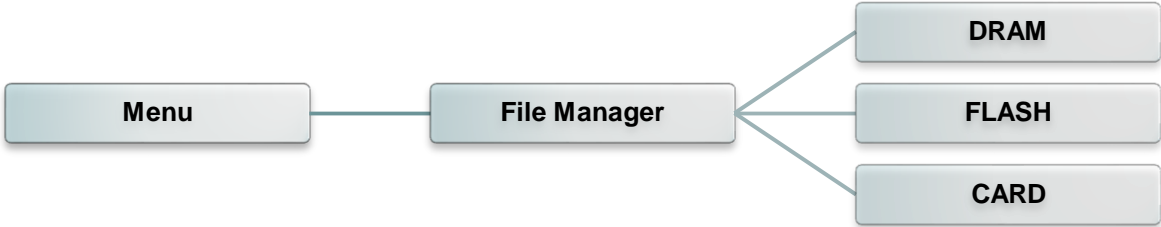

## 6.8 Diagnostic

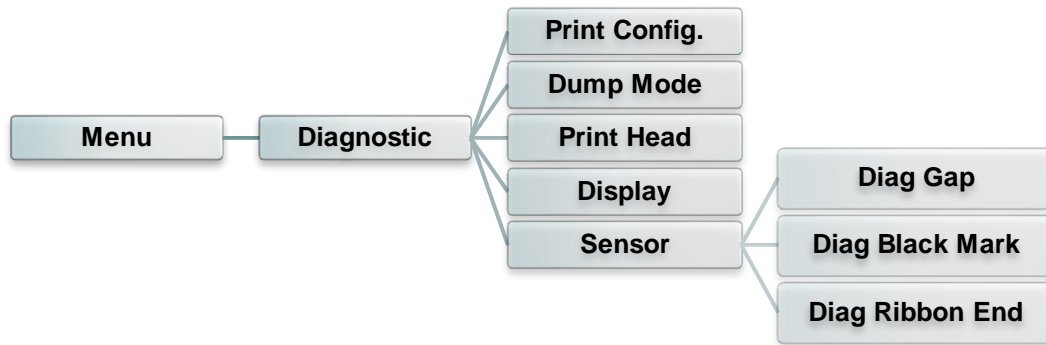

Item	Description
Print Config.	<p>This feature is used to print current printer configuration to the label. On the configuration printout, there is a print head test pattern, which is useful for checking if there is any dot damage on the print head heater element.</p> <div style="border: 1px solid black; padding: 10px; margin: 10px 0;"> <p style="text-align: center; margin: 0;"><b>Self-test printout</b></p> <pre style="font-family: monospace; font-size: 0.9em;">           -----           SYSTEM INFORMATION           -----           MODEL: XXXXXX           FIRMWARE: X.XX           CHECKSUM: XXXXXXXX           S/N: XXXXXXXXXXXX           TCF: NO           DATE: 1970/01/01           TIME: 00:04:18           NON-RESET: 110 m (TPH)           RESET: 110 m (TPH)           NON-RESET: 0 (CUT)           RESET: 0 (CUT)           -----            PRINTING SETTING           -----           SPEED: 5 IPS           DENSITY: 8.0           WIDTH: 4.00 INCH           HEIGHT: 4.00 INCH           GAP: 0.00 INCH           INTENSION: 5           CODEPAGE: 850           COUNTRY: 001           -----            Z SETTING           -----           DARKNESS: 16.0           SPEED: 4 IPS           WIDTH: 4.00 INCH           TILDE: 7EH (~)            CARET: 5EH (^)           DELIMITER: 2CH (,)           POWER UP: NO MOTION           HEAD CLOSE: NO MOTION           -----            RS232 SETTING           -----           BAUD: 9600           PARITY: NONE           DATA BIT: 8           STOP BIT: 1           -----         </pre> <p style="margin-top: 10px;"><b>Note:</b> ZPL is emulating for Zebra® language.</p> </div>

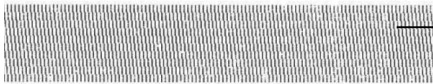
	<pre> ----- DRAM FILE (0 FILES) ----- PHYSICAL   XXXX KBYTES AVAILABLE  XXXX KBYTES -----  FLASH FILE (0 FILES) ----- PHYSICAL   XXXX KBYTES AVAILABLE  XXXX KBYTES ----- </pre>	<p>Numbers of download files Total &amp; available memory space</p>	
		<p>Print head check pattern</p> <p><b>Note:</b> Checking dot damage requires 4" wide paper width.</p>	

<b>Dump Mode</b>	<p>Captures the data from the communications port and prints out the data received by printer. In the dump mode, all characters will be printed in 2 columns. The left side characters are received from your system and right side data are the corresponding hexadecimal value of the characters. It allows users or engineers to verify and debug the program.</p>			
	<p><b>ASCII Data</b> ←</p>	<pre> DOWNLOA 0D 0A 44 4F 57 4E 4C 4F 4I D „TEST2. 44 20 22 54 45 53 54 32 2E DAT“,5,CL 44 41 54 22 2C 35 2C 43 4C S DOWNLO 53 0D 0A 44 4F 57 4E 4C 4F AD F,“TES 41 44 20 46 2C 22 54 45 53 T4.DAT“,5 54 34 2E 44 41 54 22 2C 35 ,CLS DOW 2C 43 4C 53 0D 0A 44 4F 57 NLOAD „TE 4E 4C 4F 41 44 20 22 54 45 ST2.DAT“, 53 54 32 2E 44 41 54 22 2C 5,CLS DO 35 2C 43 4C 53 0D 0A 44 4F WNLOAD F, 57 4E 4C 4F 41 44 20 46 2C „TEST4.DA 22 54 45 53 54 34 2E 44 41 T“,5,CLS 54 22 2C 35 2C 43 4C 53 0D DOWNLOAD 0A 44 4F 57 4E 4C 4F 41 44 “TEST2.D 20 22 54 45 53 54 32 2E 44 AT“,5,CLS 41 54 22 2C 35 2C 43 4C 53 DOWNLOAD 0D 0A 44 4F 57 4E 4C 4F 4I D F,“TEST 44 20 46 2C 22 54 45 53 54 4.DAT“,5, 34 2E 44 41 54 22 2C 35 2C CLS 43 4C 53 0D 0A </pre> <p style="text-align: right;"><b>Hexadecimal data related to left column of ASCII data</b></p>		
	<p><b>Note:</b> Dump mode requires 4" wide paper width.</p>			

<b>Print Head</b>	This feature is used to check print head's temperature and bad dots.
<b>Display</b>	This feature is used to check LCD's color state.
<b>Sensor</b>	This feature is used to check sensors intensity and reading state.

## 6.9 Favorites

This feature is used to create your own favorites list. You can organize the commonly used setting options in “Favorites”.

- **Select “Favorites” list**

Touch and hold left select key on main screen, the “Favorites” list will pop up.

Note: if the main menu button with locked sign, please input password to unlock the screen.

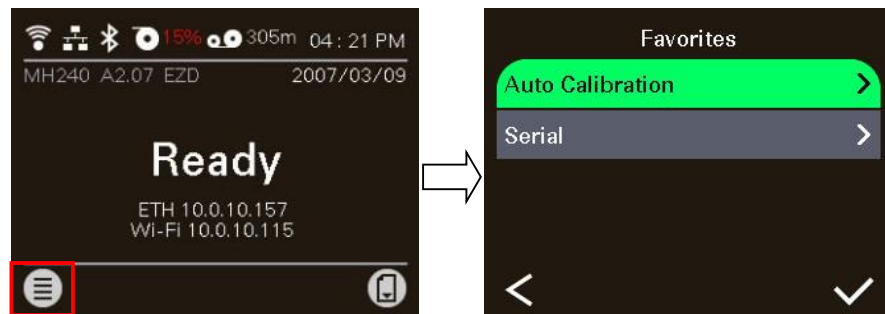

- **Get organized “Favorites” list**

Touch and hold a favorite option item by right select key, until “Join Favorites” setting screen pops up. Select “Yes” to add this setting option item to “Favorites”.

Touch and hold

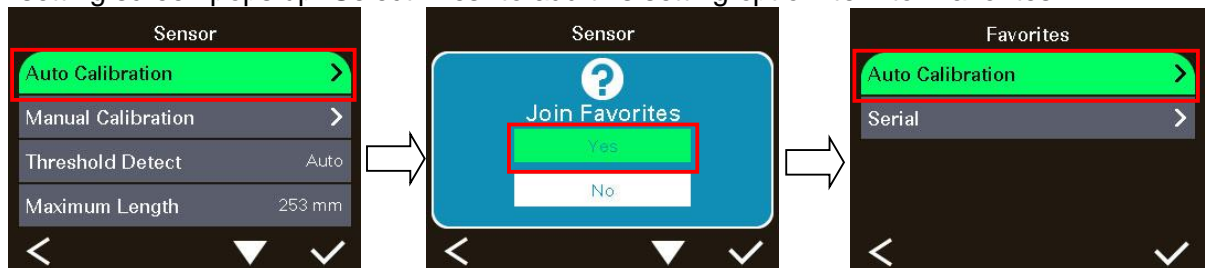

- **Delete favorites item**

Touch and hold the option item by right select key, until “Delete Favorites” setting screen pops up. Tap “Yes” to delete this setting option item on “Favorites”.

Touch and hold

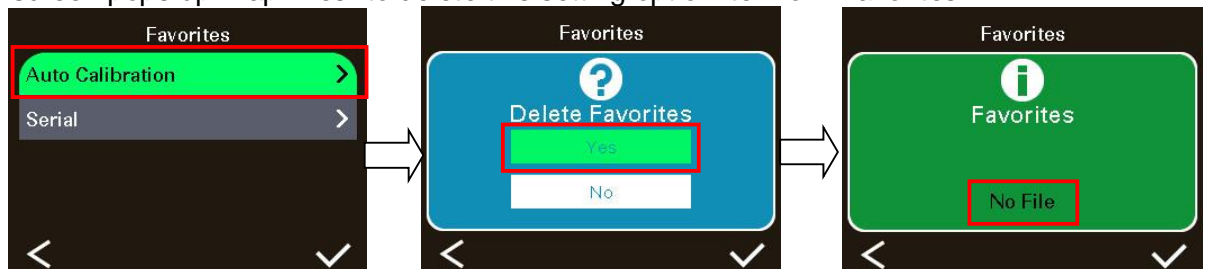

# 7. LCD Menu Function for MH240T/ MH240P Series (touch panel)

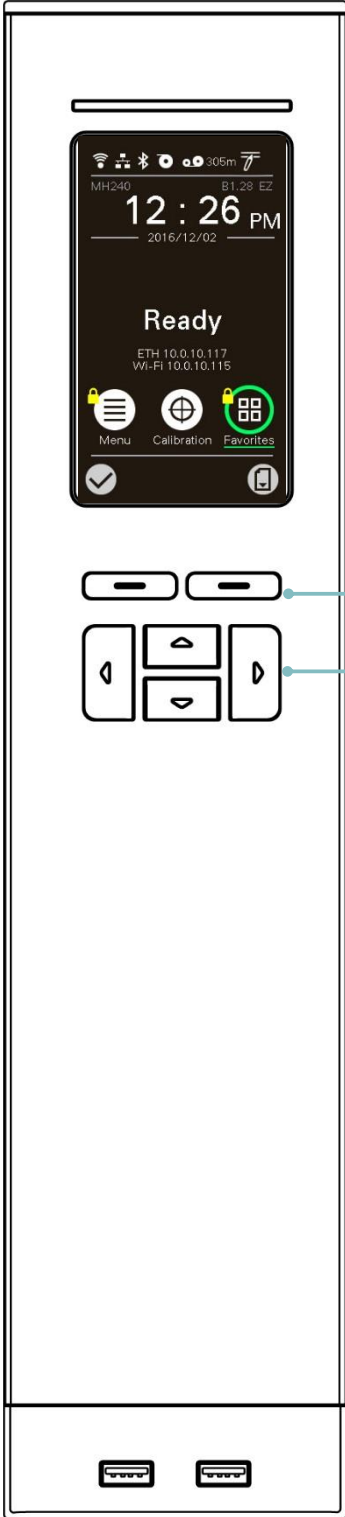

## 7.1 Enter the Menu



**\* By touch display:**

Tap the  “Menu” icon on LCD main page to enter the menu.

**\* By Keys:**

Use navigational keys to select the  “Menu” icon (be marked in green) and press the left select key button (means  ) to enter the menu.

Select keys

Navigational keys

### 7.1.1 Touch Screen

Tap an item to open/use it.





## 7.2 Menu Overview

There are 6 categories for the menu. You can easily set the settings of the printer without connecting the computer. Please refer to following sections for more details.



This "Setting" category can set up the printer settings for TSPL & ZPL2.



This "Sensor" option is used to calibrate the selected media sensor. We recommend calibrate the sensor before printing when changing the media.



This "Interface" option is used to set the printer interface settings.



This "Advanced" option is used to set the printer LCD settings, initialization, cutter type, media low warning setting %...etc.



This "File Manager" option is used to check/manager the printer available memory.



This "Diagnostic" option is used to review printer to troubleshoot problems and other issues.

### 7.3 Setting

Tap the “Command Set” item on LCD to switch the TSPL and ZPL2. Or select the “Command Set” item by navigational key and press right soft key to switch the TSPL and ZPL2.

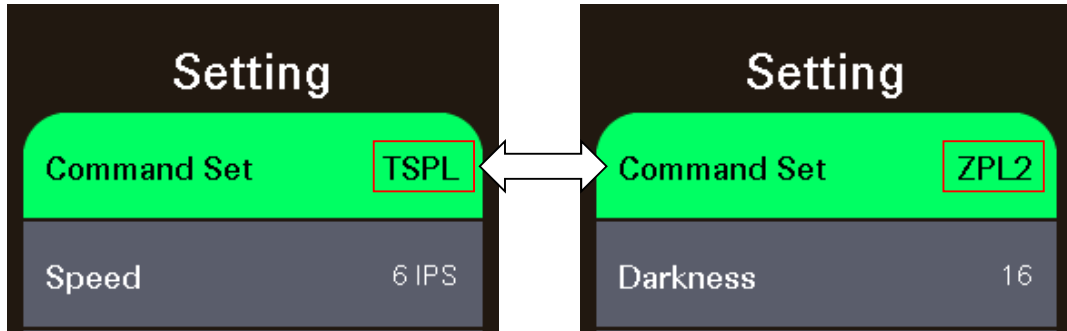

#### 7.3.1 TSPL

This “TSPL” category can set up the printer settings for TSPL.

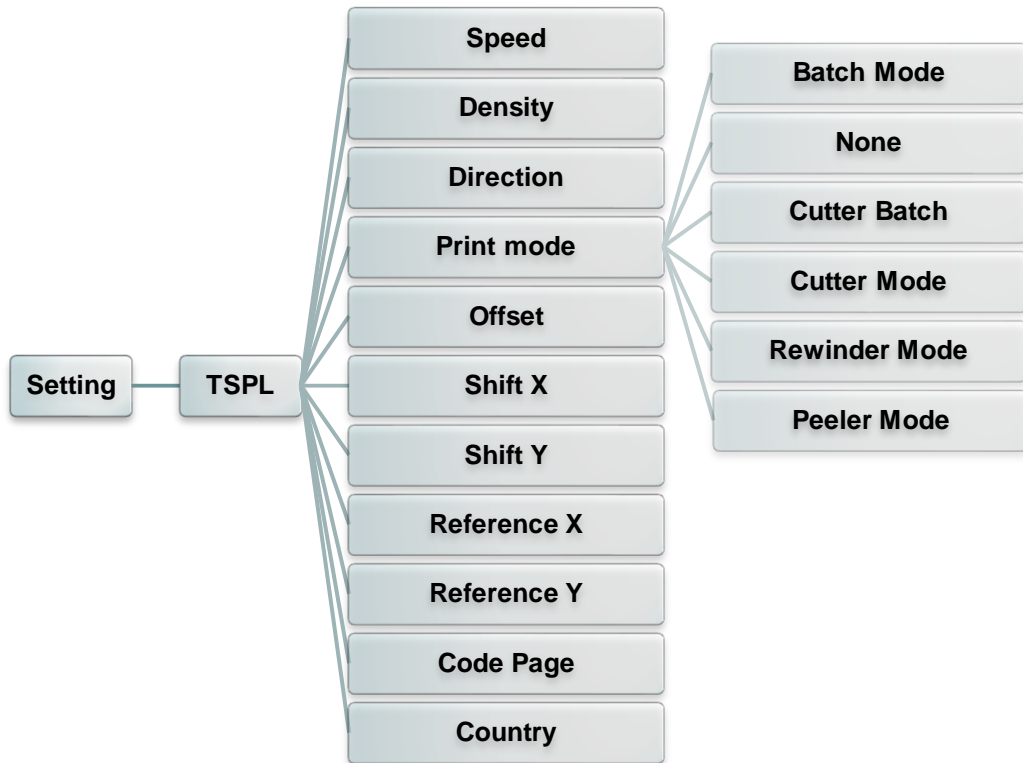

Item	Description	Default
Speed	Use this item to setup print speed. Available setting range is 2~14 for 203dpi, 2~12 for 300dpi and 1~6 for 600dpi.	203 dpi: 6 300 dpi: 4 600 dpi: 3
Density	Use this option to setup printing darkness. The available setting range is from 0 to 15, and the step is 1. You may need to adjust your density based on selected media.	8

<b>Direction</b>	<p>The direction setting value is either 1 or 0. Use this item to setup the printout direction.</p> <table border="1" style="margin-left: auto; margin-right: auto;"> <thead> <tr> <th style="width: 50%;">DIRECTION 0</th> <th style="width: 50%;">DIRECTION 1</th> </tr> </thead> <tbody> <tr> <td style="text-align: center; vertical-align: middle;"> <div style="border: 1px solid black; padding: 10px; width: 80px; margin: 0 auto;">Direction</div> </td> <td style="text-align: center; vertical-align: middle;"> <div style="border: 1px solid black; padding: 10px; width: 80px; margin: 0 auto; transform: rotate(180deg);">Direction</div> </td> </tr> </tbody> </table>	DIRECTION 0	DIRECTION 1	<div style="border: 1px solid black; padding: 10px; width: 80px; margin: 0 auto;">Direction</div>	<div style="border: 1px solid black; padding: 10px; width: 80px; margin: 0 auto; transform: rotate(180deg);">Direction</div>	<b>0</b>										
DIRECTION 0	DIRECTION 1															
<div style="border: 1px solid black; padding: 10px; width: 80px; margin: 0 auto;">Direction</div>	<div style="border: 1px solid black; padding: 10px; width: 80px; margin: 0 auto; transform: rotate(180deg);">Direction</div>															
<b>Print mode</b>	<p>This item is used to set the print mode. There are 6 modes as below,</p> <table border="1" style="margin-left: auto; margin-right: auto;"> <thead> <tr> <th style="width: 20%;">Printer Mode</th> <th style="width: 80%;">Description</th> </tr> </thead> <tbody> <tr> <td style="text-align: center;">None</td> <td>Next label top of form is aligned to the print head burn line location. (Tear Off Mode)</td> </tr> <tr> <td style="text-align: center;">Cutter Batch</td> <td>Cut the label once at the end of the printing job.</td> </tr> <tr> <td style="text-align: center;">Cutter Mode</td> <td>Enable the label cutter mode.</td> </tr> <tr> <td style="text-align: center;">Rewinder Mode</td> <td>Enable the label rewinder mode.</td> </tr> <tr> <td style="text-align: center;">Peeler Mode</td> <td>Enable the label peel off mode.</td> </tr> <tr> <td style="text-align: center;">Batch Mode</td> <td>Once image is printed completely, label gap/black mark will be fed to the tear plate location for tear away.</td> </tr> </tbody> </table>	Printer Mode	Description	None	Next label top of form is aligned to the print head burn line location. (Tear Off Mode)	Cutter Batch	Cut the label once at the end of the printing job.	Cutter Mode	Enable the label cutter mode.	Rewinder Mode	Enable the label rewinder mode.	Peeler Mode	Enable the label peel off mode.	Batch Mode	Once image is printed completely, label gap/black mark will be fed to the tear plate location for tear away.	<b>Batch Mode</b>
Printer Mode	Description															
None	Next label top of form is aligned to the print head burn line location. (Tear Off Mode)															
Cutter Batch	Cut the label once at the end of the printing job.															
Cutter Mode	Enable the label cutter mode.															
Rewinder Mode	Enable the label rewinder mode.															
Peeler Mode	Enable the label peel off mode.															
Batch Mode	Once image is printed completely, label gap/black mark will be fed to the tear plate location for tear away.															
<b>Offset</b>	This item is used to fine tune media stop location. Available setting value range is from -999 dots to 999 dots.	<b>0 dot</b>														
<b>Shift X</b>	This item is used to fine tune print position. Available setting value range is from -999 dots to 999 dots.	<b>0 dot</b>														
<b>Shift Y</b>		<b>0 dot</b>														
<b>Reference X</b>	This item is used to set the origin of printer coordinate system horizontally and vertically. Available setting range is from 0 dot to 999 dots.	<b>0 dot</b>														
<b>Reference Y</b>		<b>0 dot</b>														
<b>Code page</b>	Use this item to set the code page of international character set.	<b>950</b>														
<b>Country</b>	Use this option to set the country code. Available setting value range is from 1 to 358.	<b>001</b>														

***Note: If printing from enclosed software/driver, the software/driver will send out the commands, which will overwrite the settings set from the panel.***

### 7.3.2 ZPL2

This “ZPL2” category can set up the printer settings for ZPL2.

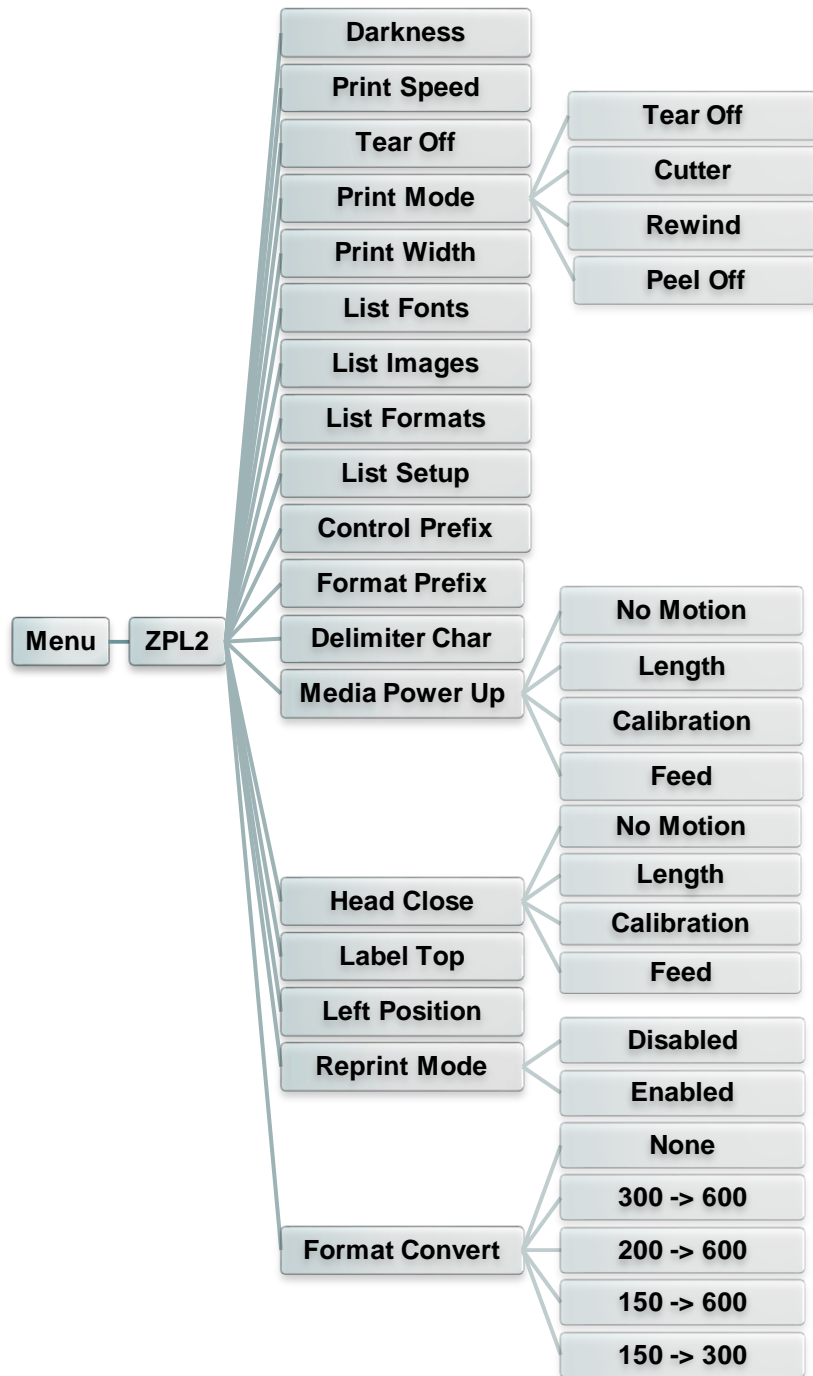

Item	Description	Default
<b>Density</b>	Use this item to setup printing darkness. The available setting range is from 0 to 30. You may need to adjust your density based on selected media.	<b>16</b>
<b>Print Speed</b>	Use this item to setup print speed. Available setting range is 2~18 for 203dpi, 2~14 for 300dpi and 1.5 ~6 for 600dpi.	<b>203 dpi: 6 300 dpi: 4 600 dpi: 3</b>

<b>Tear Off</b>	This item is used to fine tune media stop location. Available setting value range is from -120~120 dots.	<b>0 dot</b>										
<b>Print mode</b>	<p>This item is used to set the print mode. There are 3 modes as below,</p> <table border="1"> <thead> <tr> <th>Printer Mode</th> <th>Description</th> </tr> </thead> <tbody> <tr> <td>Tear Off</td> <td>Next label top of form is aligned to the print head burn line location.</td> </tr> <tr> <td>Peel Off</td> <td>Enable the label peel off mode.</td> </tr> <tr> <td>Cutter</td> <td>Enable the label cutter mode</td> </tr> <tr> <td>Rewind</td> <td>Enable the label rewind mode</td> </tr> </tbody> </table>	Printer Mode	Description	Tear Off	Next label top of form is aligned to the print head burn line location.	Peel Off	Enable the label peel off mode.	Cutter	Enable the label cutter mode	Rewind	Enable the label rewind mode	<b>Tear Off</b>
Printer Mode	Description											
Tear Off	Next label top of form is aligned to the print head burn line location.											
Peel Off	Enable the label peel off mode.											
Cutter	Enable the label cutter mode											
Rewind	Enable the label rewind mode											
<b>Print Width</b>	This item is used to set print width. The available value range is 2 ~ 999 dots.	<b>812</b>										
<b>List Fonts</b>	This feature is used to print current printer available fonts list to the label. The fonts stored in the printer's DRAM, Flash or optional memory card.	<b>N/A</b>										
<b>List Images</b>	This feature is used to print current printer available images list to the label. The images stored in the printer's DRAM, Flash or optional memory card.	<b>N/A</b>										
<b>List Formats</b>	This feature is used to print current printer available formats list to the label. The formats stored in the printer's DRAM, Flash or optional memory card.	<b>N/A</b>										
<b>List Setup</b>	This feature is used to print current printer configuration to the label.	<b>N/A</b>										
<b>Control Prefix</b>	This feature is used to set control prefix character.	<b>N/A</b>										
<b>Format Prefix</b>	This feature is used to set format prefix character.	<b>N/A</b>										
<b>Delimiter Char</b>	This feature is used to set delimiter character.	<b>N/A</b>										
<b>Media Power Up</b>	<p>This option is used to set the action of the media when you turn on the printer.</p> <table border="1"> <thead> <tr> <th>Selections</th> <th>Description</th> </tr> </thead> <tbody> <tr> <td>Feed</td> <td>Printer will advance one label</td> </tr> <tr> <td>Calibration</td> <td>Printer will calibration the sensor levels, determine length and feed label</td> </tr> <tr> <td>Length</td> <td>Printer determine length and feed label</td> </tr> <tr> <td>No Motion</td> <td>Printer will not move media</td> </tr> </tbody> </table>	Selections	Description	Feed	Printer will advance one label	Calibration	Printer will calibration the sensor levels, determine length and feed label	Length	Printer determine length and feed label	No Motion	Printer will not move media	<b>No Motion</b>
Selections	Description											
Feed	Printer will advance one label											
Calibration	Printer will calibration the sensor levels, determine length and feed label											
Length	Printer determine length and feed label											
No Motion	Printer will not move media											
<b>Head Close</b>	<p>This option is used to set the action of the media when you close the print head.</p> <table border="1"> <thead> <tr> <th>Selections</th> <th>Description</th> </tr> </thead> <tbody> <tr> <td>Feed</td> <td>Printer will advance one label</td> </tr> <tr> <td>Calibration</td> <td>Printer will calibration the sensor levels, determine length and feed label</td> </tr> <tr> <td>Length</td> <td>Printer determine length and feed label</td> </tr> <tr> <td>No Motion</td> <td>Printer will not move media</td> </tr> </tbody> </table>	Selections	Description	Feed	Printer will advance one label	Calibration	Printer will calibration the sensor levels, determine length and feed label	Length	Printer determine length and feed label	No Motion	Printer will not move media	<b>No Motion</b>
Selections	Description											
Feed	Printer will advance one label											
Calibration	Printer will calibration the sensor levels, determine length and feed label											
Length	Printer determine length and feed label											
No Motion	Printer will not move media											
<b>Label Top</b>	This option is used to adjust print position vertically on the label. The range is -120 to +120 dots.	<b>0</b>										
<b>Left Position</b>	This option is used to adjust print position horizontally on the label. The range is -9999 to +9999 dots.	<b>0</b>										

<b>Reprint Mode</b>	When reprint mode is enabled, you can reprint the last label printer by pressing  button on printer's control panel.	<b>Disabled</b>
<b>Format Convert</b>	Selects the bitmap scaling factor. The first number is the original dots per inch (dpi) value; the second, the dpi to which you would like to scale.	<b>None</b>

***Note: If printing from enclosed software/driver, the software/driver will send out the commands, which will overwrite the settings set from the panel.***

## 7.4 Sensor

This option is used to calibrate the selected sensor. We recommend calibrate the sensor before printing when changing the media.

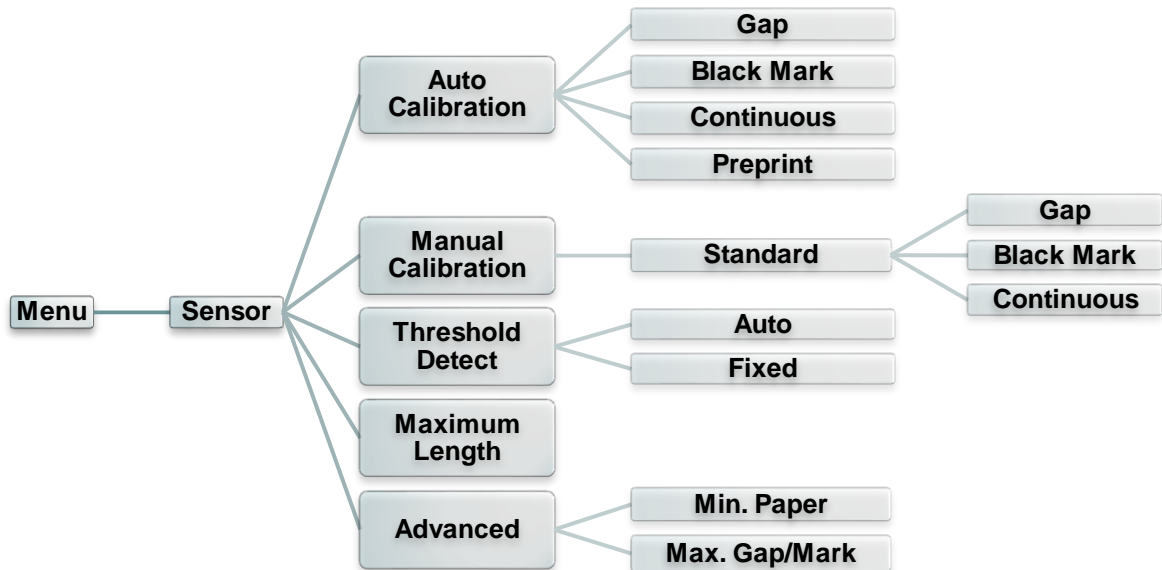

Item	Description	Default
<b>Auto Calibration</b>	This option is used to set the media sensor type and calibrate the selected sensor automatically. Printer will feed 2 to 3 gap labels to calibrate the sensor sensitivity automatically.	<b>N/A</b>
<b>Manual setup</b>	In case “Automatic” cannot apply to the media, please use “Manual” function to set the paper length and gap/bline size then scan the backing/mark to calibrate the sensor sensitivity.  <b>Note: The “Media Capacity” item is used to calibrate the media capacity sensor %.</b>	<b>N/A</b>
<b>Threshold Detect</b>	This option is used to set sensor sensitivity in fixed or auto.	<b>Auto</b>
<b>Maximum Length</b>	This option is used to set the maximum length for label calibration.	<b>253 mm</b>
<b>Advanced</b>	This function can set the minimum paper length and maximum gap/bline length for auto-calibrate the sensor sensitivity.	<b>0 mm</b>

## 7.5 Interface

This option is used to set the printer interface settings.

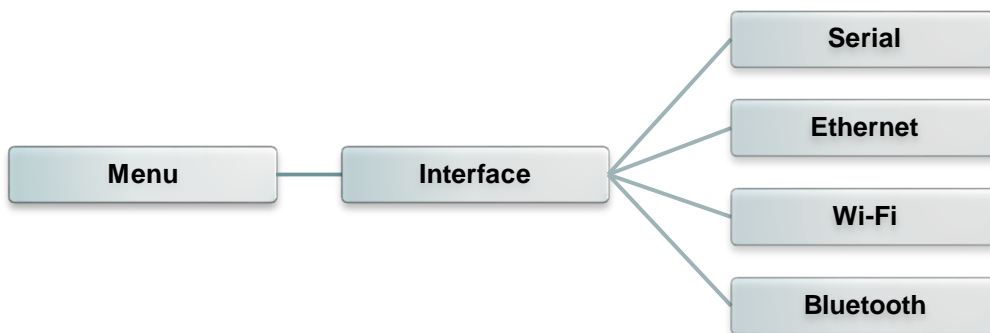

### 7.5.1 Serial Comm.

This option is used to set the printer RS-232 settings.

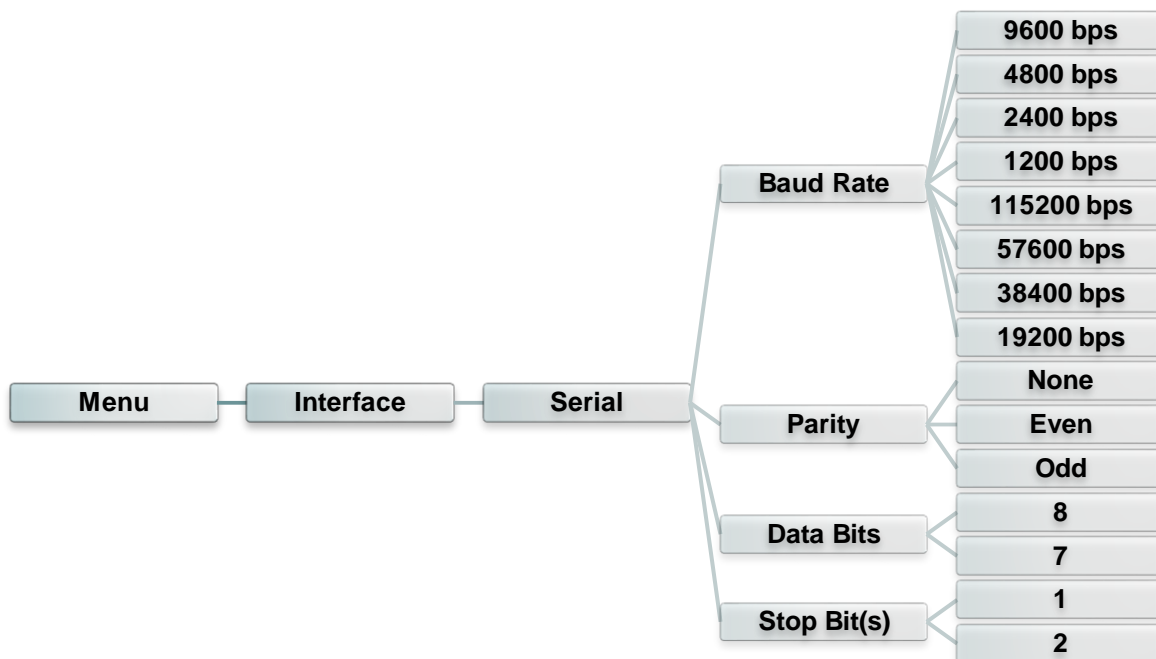

Item	Description	Default
<b>Baud Rate</b>	This item is used to set the RS-232 baud rate.	<b>9600</b>
<b>Parity</b>	This item is used to set the RS-232 parity.	<b>None</b>
<b>Data Bits</b>	This item is used to set the RS-232 Data Bits.	<b>8</b>
<b>Stop Bit(s)</b>	This item is used to set the RS-232 Stop Bits.	<b>1</b>



## 7.5.2 Ethernet

Use this menu to configure internal Ethernet configuration check the printer's Ethernet module status, and reset the Ethernet module.

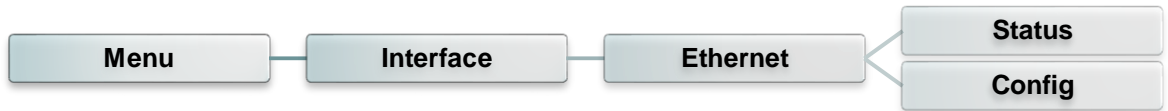

Item	Description	Default
Status	Use this menu to check the Ethernet IP address and MAC setting status.	N/A
Config.	<b>DHCP:</b> This item is used to ON or OFF the DHCP (Dynamic Host Configuration Protocol) network protocol.  <b>Static IP:</b> Use this menu to set the printer's IP address, subnet mask and gateway.	DHCP

### 7.5.3 Wi-Fi

This option is used to set the printer Wi-Fi settings.

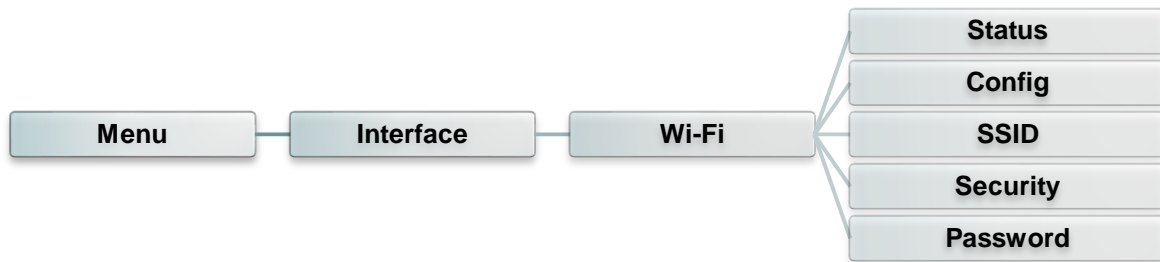

Item	Description	Default
<b>Status</b>	Use this menu to check the Wi-Fi IP address, MAC setting status....	<b>N/A</b>
<b>Config.</b>	<p><b>DHCP:</b> This item is used to ON or OFF the DHCP (Dynamic Host Configuration Protocol) network protocol.</p> <p><b>Static IP:</b> Use this menu to set the printer's IP address, subnet mask and gateway.</p>	<b>DHCP</b>
<b>SSID</b>	Use this menu to set the Wi-Fi SSID	<b>N/A</b>
<b>Security</b>	Use this menu to set the Wi-Fi security	<b>Open</b>
<b>Password</b>	Use this menu to set the Wi-Fi password	<b>N/A</b>

### 7.5.4 Bluetooth

This option is used to set the printer Bluetooth settings.

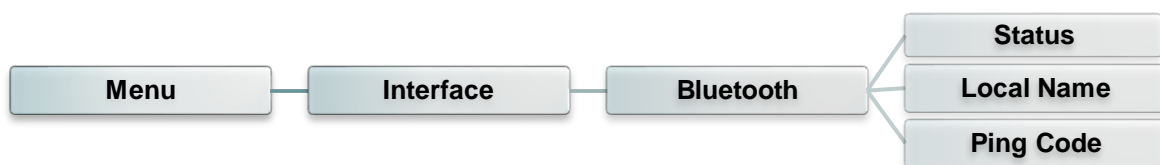

Item	Description	Default
<b>Status</b>	Use this menu to check the Bluetooth status.	<b>N/A</b>
<b>Local Name</b>	This item is used to set the local name for Bluetooth.	<b>RF-BHS</b>
<b>Ping Code</b>	This item is used to set the local ping code for Bluetooth.	<b>0000</b>

## 7.6 Advanced

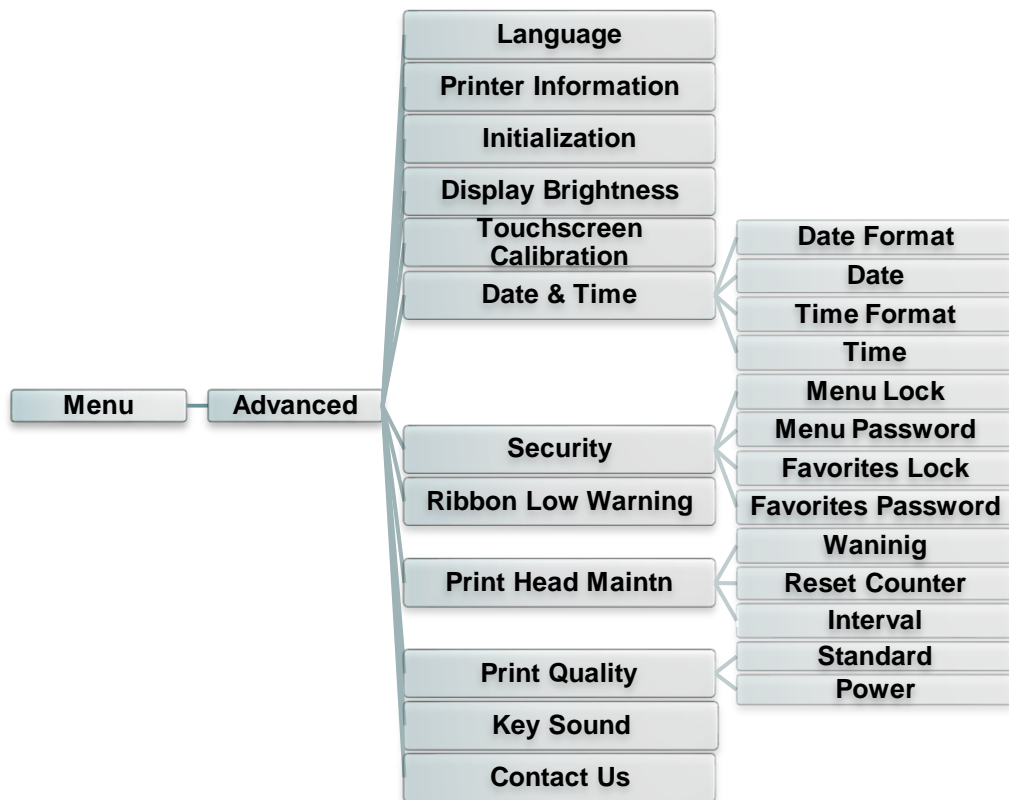

Item	Description	Default
<b>Language</b>	This item is used to setup the language on display.	<b>English</b>
<b>Printer Information</b>	This feature is used to check the printer serial number, printed mileage (m), printed labels (pcs) and cutting counter.	<b>N/A</b>
<b>Initialization</b>	This feature is used to restore printer settings to defaults.	<b>N/A</b>
<b>Display Brightness</b>	This item is used to setup the brightness for display. (Range 0~100)	<b>50</b>
<b>Touchscreen Calibration</b>	This feature is used to calibrate the touchscreen for best result.	<b>N/A</b>
<b>Date &amp; Time</b>	This item is used to setup the date and time on display.	<b>N/A</b>
<b>Security</b>	This feature is used to set the password for locking the menu or favorites. The default password is 8888.	<b>Disable</b>
<b>Ribbon Low Warning</b>	This item is used to set the warning for ribbon low. For example, if setting value is 30m, when ribbon capacity was lower than 30m, the  will be shown in red.	<b>30m</b>

<b>Printer Head Maintn</b>	This item is used to check print head status and to set the settings for print head care.	<b>N/A</b>								
	<table border="1"> <thead> <tr> <th><b>Item</b></th> <th><b>Description</b></th> </tr> </thead> <tbody> <tr> <td>Warning</td> <td>This item is used to enable/disable the print head clean warning. If enable this feature, once print head has been reached the setting mileage then the warning icon will be shown on printer UI for reminding user to clean the print head. The default setting is disable.</td> </tr> <tr> <td>Reset Counter</td> <td>This item is used to reset the print head clean warning mileage after cleaned print head.</td> </tr> <tr> <td>Interval</td> <td>This item is used to set the expected mileage for reminding user to clean the print head. You have to enable the "TPH warning lock" for use. The default setting is 1 km.</td> </tr> </tbody> </table>		<b>Item</b>	<b>Description</b>	Warning	This item is used to enable/disable the print head clean warning. If enable this feature, once print head has been reached the setting mileage then the warning icon will be shown on printer UI for reminding user to clean the print head. The default setting is disable.	Reset Counter	This item is used to reset the print head clean warning mileage after cleaned print head.	Interval	This item is used to set the expected mileage for reminding user to clean the print head. You have to enable the "TPH warning lock" for use. The default setting is 1 km.
	<b>Item</b>		<b>Description</b>							
	Warning		This item is used to enable/disable the print head clean warning. If enable this feature, once print head has been reached the setting mileage then the warning icon will be shown on printer UI for reminding user to clean the print head. The default setting is disable.							
Reset Counter	This item is used to reset the print head clean warning mileage after cleaned print head.									
Interval	This item is used to set the expected mileage for reminding user to clean the print head. You have to enable the "TPH warning lock" for use. The default setting is 1 km.									
<b>Print Quality</b>	This item is used to select the print quality to standard/power mode.	<b>Standard</b>								
<b>Key Sound</b>	This item is used to open/close the key sound.	<b>ON</b>								
<b>Contact us</b>	This feature is used to check the contact information for tech support service	<b>N/A</b>								

# 7.7 File Manager

This feature is used to check the printer available memory, show the files list, delete the files or run the files that saved in the printer DRAM/Flash/Card memory.

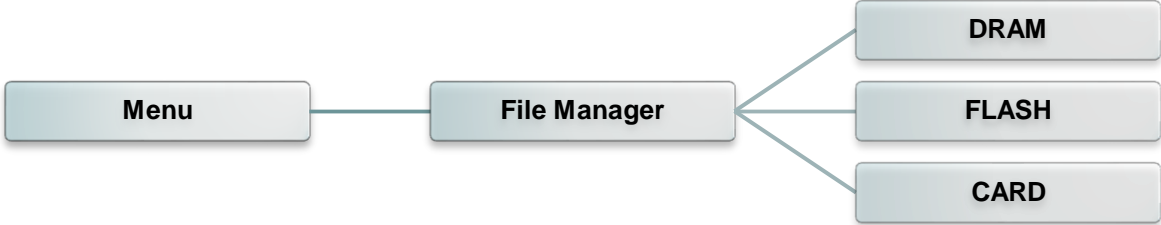

## 7.8 Diagnostic

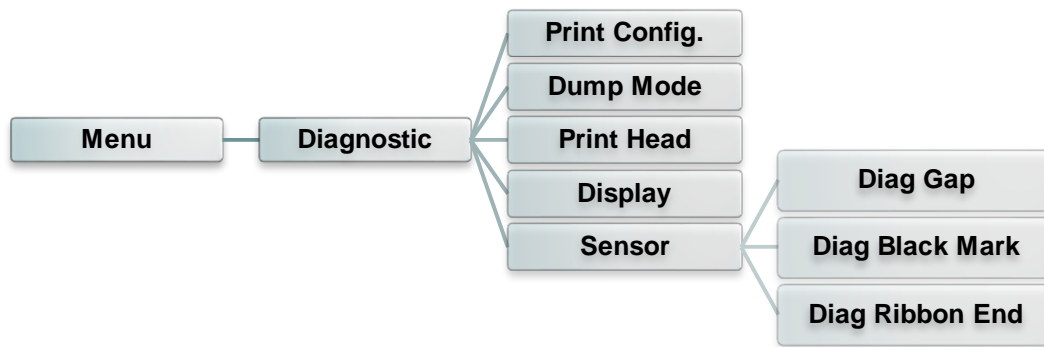

Item	Description
Print Config.	<p>This feature is used to print current printer configuration to the label. On the configuration printout, there is a print head test pattern, which is useful for checking if there is any dot damage on the print head heater element.</p> <div data-bbox="491 801 1311 2033" style="border: 1px solid black; padding: 10px;"> <p style="text-align: center;"><b>Self-test printout</b></p> <pre> ----- SYSTEM INFORMATION ----- MODEL: XXXXXX FIRMWARE: X.XX CHECKSUM: XXXXXXXX S/N: XXXXXXXXXXXX TCF: NO DATE: 1970/01/01 TIME: 00:04:18 NON-RESET: 110 m (TPH) RESET: 110 m (TPH) NON-RESET: 0 (CUT) RESET: 0 (CUT) -----  PRINTING SETTING ----- SPEED: 5 IPS DENSITY: 8.0 WIDTH: 4.00 INCH HEIGHT: 4.00 INCH GAP: 0.00 INCH INTENSION: 5 CODEPAGE: 850 COUNTRY: 001 -----  Z SETTING ----- DARKNESS: 16.0 SPEED: 4 IPS WIDTH: 4.00 INCH TILDE: 7EH (~)  CARET: 5EH (^) DELIMITER: 2CH (,) POWER UP: NO MOTION HEAD CLOSE: NO MOTION -----  RS232 SETTING ----- BAUD: 9600 PARITY: NONE DATA BIT: 8 STOP BIT: 1 -----           </pre> <p style="text-align: right;"><b>Note:</b> ZPL is emulating for Zebra® language.</p> </div>

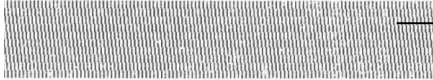
	<pre> ----- DRAM FILE (0 FILES) ----- PHYSICAL  XXXX KBYTES AVAILABLE  XXXX KBYTES -----  FLASH FILE (0 FILES) ----- PHYSICAL  XXXX KBYTES AVAILABLE  XXXX KBYTES ----- </pre>	<p>Numbers of download files Total &amp; available memory space</p>	
		<p>Print head check pattern</p> <p><b>Note:</b> Checking dot damage requires 4" wide paper width.</p>	

<b>Dump Mode</b>	<p>Captures the data from the communications port and prints out the data received by printer. In the dump mode, all characters will be printed in 2 columns. The left side characters are received from your system and right side data are the corresponding hexadecimal value of the characters. It allows users or engineers to verify and debug the program.</p>			
	<p><b>ASCII Data</b> ←</p>	<pre> DOWNLOA 0D 0A 44 4F 57 4E 4C 4F 4I D „TEST2. 44 20 22 54 45 53 54 32 2E DAT“,5,CL 44 41 54 22 2C 35 2C 43 4C S DOWNLO 53 0D 0A 44 4F 57 4E 4C 4F AD F,“TES 41 44 20 46 2C 22 54 45 53 T4.DAT“,5 54 34 2E 44 41 54 22 2C 35 ,CLS DOW 2C 43 4C 53 0D 0A 44 4F 57 NLOAD „TE 4E 4C 4F 41 44 20 22 54 45 ST2.DAT“, 53 54 32 2E 44 41 54 22 2C 5,CLS DO 35 2C 43 4C 53 0D 0A 44 4F WNLOAD F, 57 4E 4C 4F 41 44 20 46 2C „TEST4.DA 22 54 45 53 54 34 2E 44 41 T“,5,CLS 54 22 2C 35 2C 43 4C 53 0D DOWNLOAD 0A 44 4F 57 4E 4C 4F 41 44 “TEST2.D 20 22 54 45 53 54 32 2E 44 AT“,5,CLS 41 54 22 2C 35 2C 43 4C 53 DOWNLOAD 0D 0A 44 4F 57 4E 4C 4F 4I D F,“TEST 44 20 46 2C 22 54 45 53 54 4.DAT“,5, 34 2E 44 41 54 22 2C 35 2C CLS 43 4C 53 0D 0A </pre> <p style="text-align: center;"><b>Hexadecimal data related to left column of ASCII data</b></p>		
	<p><b>Note:</b> Dump mode requires 4" wide paper width.</p>			

<b>Print Head</b>	This feature is used to check print head's temperature and bad dots.
<b>Display</b>	This feature is used to check LCD's color state.
<b>Sensor</b>	This feature is used to check sensors intensity and reading state.

## 7.9 Favorites

This feature is used to create your own favorites list. You can organize the commonly used setting options in “Favorites” .

- **Select “Favorites” list**

Touch and hold left select key on main screen or holding the finger on “Favorites” icon , the “Favorites” list will pop up.

Note: if the main menu button with locked sign, please input password to unlock the screen.

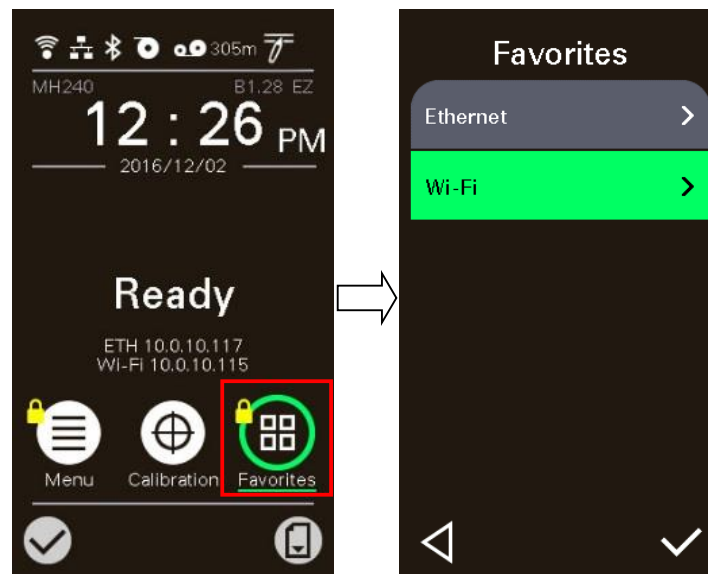

- **Get organized “Favorites” list**

Touch and hold a favorite option item, until “Join Favorites” setting screen pops up. Tap “Yes” to add this setting option item to “Favorites”.

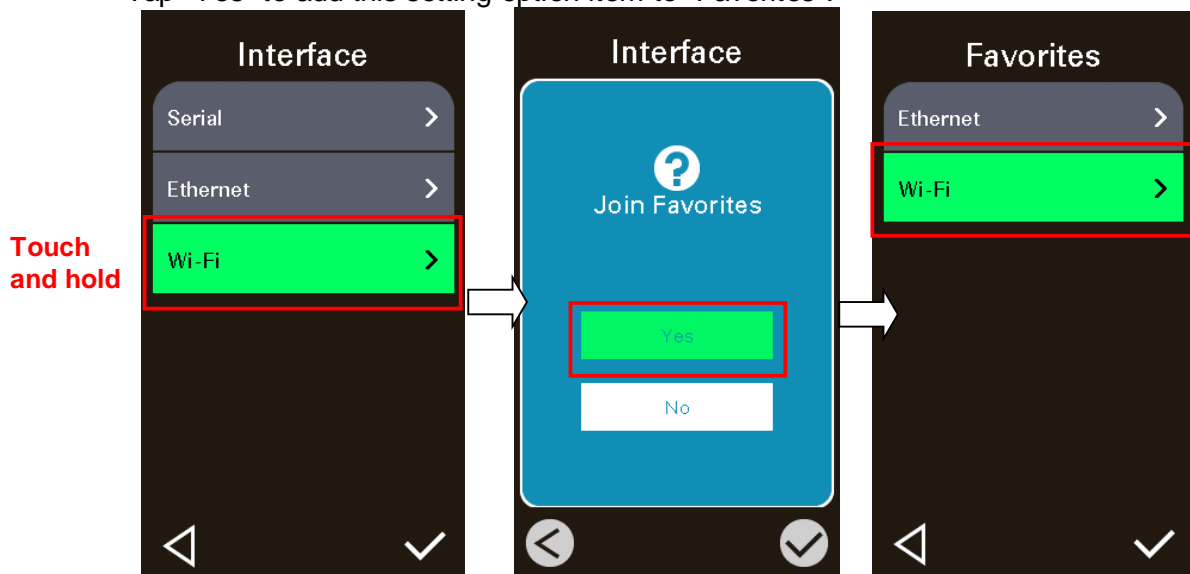



- **Delete favorites item**

Touch and hold the option item, until “Delete Favorites” setting screen pops up. Tap “Yes” to delete this setting option item on “Favorites”.

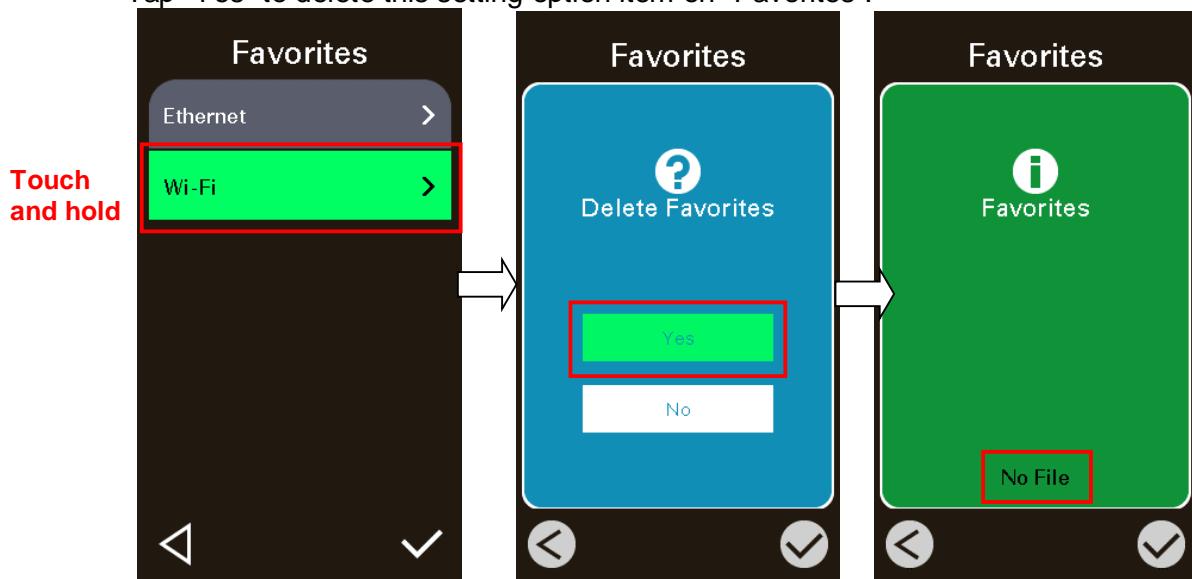

## 8. Troubleshooting

The following guide lists the most common problems that may be encountered when operating this bar code printer. If the printer still does not function after all suggested solutions have been invoked, please contact the Customer Service Department of your purchased reseller or distributor for assistance.

Problem	Possible Cause	Recovery Procedure
<b>Power indicator does not illuminate</b>	<ul style="list-style-type: none"> <li>* The power cord is not properly connected.</li> <li>* The power switch is closed.</li> </ul>	<ul style="list-style-type: none"> <li>* Plug the power cord in printer and outlet.</li> <li>* Switch the printer on.</li> </ul>
<b>Carriage Open</b>	<ul style="list-style-type: none"> <li>* The printer carriage is open.</li> </ul>	<ul style="list-style-type: none"> <li>* Please close the print carriage.</li> </ul>
<b>Not Printing</b>	<ul style="list-style-type: none"> <li>* Check if interface cable is well connected to the interface connector.</li> <li>* Check if wireless or Bluetooth device is well connected between host and printer.</li> <li>* The port specified in the Windows driver is not correct.</li> </ul>	<ul style="list-style-type: none"> <li>* Re-connect cable to interface or change a new cable.</li> <li>* Please reset the wireless device setting.</li> <li>* Select the correct printer port in the driver.</li> <li>* Clean the printhead.</li> <li>* Printhead's harness connector is not well connected with printhead. Turn off the printer and plug the connector again.</li> <li>* Check your program if there is a command PRINT at the end of the file and there must have CRLF at the end of each command line.</li> </ul>
<b>No print on the label</b>	<ul style="list-style-type: none"> <li>* Label or ribbon is loaded not correctly.</li> <li>* Use wrong type paper or ribbon</li> </ul>	<ul style="list-style-type: none"> <li>* Follow the instructions in loading the media and ribbon.</li> <li>* Ribbon and media are not compatible.</li> <li>* Verify the ribbon-inked side.</li> <li>* The print density setting is incorrect.</li> </ul>
<b>No Ribbon</b>	<ul style="list-style-type: none"> <li>* Running out of ribbon.</li> <li>* The ribbon is installed incorrectly.</li> </ul>	<ul style="list-style-type: none"> <li>* Supply a new ribbon roll.</li> <li>* Please refer to the steps in user's manual to reinstall the ribbon.</li> </ul>
<b>No Paper</b>	<ul style="list-style-type: none"> <li>* Running out of label.</li> <li>* The label is installed incorrectly.</li> <li>* Gap/black mark sensor is not calibrated.</li> </ul>	<ul style="list-style-type: none"> <li>* Supply a new label roll.</li> <li>* Please refer to the steps in user's manual to reinstall the label roll.</li> <li>* Calibrate the gap/black mark sensor.</li> </ul>
<b>Paper Jam</b>	<ul style="list-style-type: none"> <li>* Gap/black mark sensor is not set properly.</li> <li>* Make sure label size is set properly.</li> <li>* Labels may be stuck inside the printer mechanism.</li> </ul>	<ul style="list-style-type: none"> <li>* Calibrate the media sensor.</li> <li>* Set media size correctly.</li> <li>* Remove the stuck label inside the printer mechanism.</li> </ul>
<b>Take Label</b>	<ul style="list-style-type: none"> <li>* Peel function is enabled.</li> </ul>	<ul style="list-style-type: none"> <li>* If the peeler module is installed, please remove the label.</li> <li>* If there is no peeler module in front of the printer, please switch off the printer and install it.</li> <li>* Check if the connector is plugging correctly.</li> </ul>
<b>Can't downloading the file to memory (FLASH / DRAM/CARD)</b>	<ul style="list-style-type: none"> <li>* The space of memory is full.</li> </ul>	<ul style="list-style-type: none"> <li>* Delete unused files in the memory.</li> </ul>

<b>microSD card is unable to use</b>	<ul style="list-style-type: none"> <li>* microSD card is damaged.</li> <li>* microSD card doesn't insert correctly.</li> <li>* Use the non-approved SD card manufacturer.</li> </ul>	<ul style="list-style-type: none"> <li>* Use the supported capacity microSD card.</li> <li>* Insert the microSD card again.</li> <li>* The supported microSD card spec and the approved microSD card manufacturers, please refer to section 2.2.3.</li> </ul>
<b>Poor Print Quality</b>	<ul style="list-style-type: none"> <li>* Ribbon and media is loaded incorrectly</li> <li>* Dust or adhesive accumulation on the print head.</li> <li>* Print density is not set properly.</li> <li>* Printhead element is damaged.</li> <li>* Ribbon and media are incompatible.</li> <li>* The printhead pressure is not set properly.</li> </ul>	<ul style="list-style-type: none"> <li>* Reload the supply.</li> <li>* Clean the print head.</li> <li>* Clean the platen roller.</li> <li>* Adjust the print density and print speed.</li> <li>* Run printer self-test and check the print head test pattern if there is dot missing in the pattern.</li> <li>* Change proper ribbon or proper label media.</li> <li>* Adjust the printhead pressure adjustment knob.</li> <li>* The release lever does not latch the printhead properly.</li> </ul>
<b>Missing printing on the left or right side of label</b>	<ul style="list-style-type: none"> <li>* Wrong label size setup.</li> </ul>	<ul style="list-style-type: none"> <li>* Set the correct label size.</li> </ul>
<b>Gray line on the blank label</b>	<ul style="list-style-type: none"> <li>* The print head is dirty.</li> <li>* The platen roller is dirty.</li> </ul>	<ul style="list-style-type: none"> <li>* Clean the print head.</li> <li>* Clean the platen roller. (Please refer to chapter 9)</li> </ul>
<b>Irregular printing</b>	<ul style="list-style-type: none"> <li>* The printer is in Hex Dump mode.</li> <li>* The RS-232 setting is incorrect.</li> </ul>	<ul style="list-style-type: none"> <li>* Turn off and on the printer to skip the dump mode.</li> <li>* Re-set the Rs-232 setting.</li> </ul>
<b>Label feeding is not stable (skew) when printing</b>	<ul style="list-style-type: none"> <li>* The media guide does not touch the edge of the media.</li> </ul>	<ul style="list-style-type: none"> <li>* If the label is moving to the right side, please move the label guide to left.</li> <li>* If the label is moving to the left side, please move the label guide to right.</li> </ul>
<b>Skip labels when printing</b>	<ul style="list-style-type: none"> <li>* Label size is not specified properly.</li> <li>* Sensor sensitivity is not set properly.</li> <li>* The media sensor is covered with dust.</li> </ul>	<ul style="list-style-type: none"> <li>* Check if label size is setup correctly.</li> <li>* Calibrate the sensor by Auto Gap or Manual Gap options.</li> <li>* Clear the GAP/Black mark sensor by blower.</li> </ul>
<b>Wrinkle Problem</b>	<ul style="list-style-type: none"> <li>* Printhead pressure is incorrect.</li> <li>* Ribbon installation is incorrect.</li> <li>* Media installation is incorrect.</li> <li>* Print density is incorrect.</li> <li>* Media feeding is incorrect.</li> </ul>	<ul style="list-style-type: none"> <li>* Please refer to the next chapter.</li> <li>* Please set the suitable density to have good print quality.</li> <li>* Make sure the label guide touch the edge of the media guide.</li> </ul>
<b>RTC time is incorrect when reboot the printer</b>	<ul style="list-style-type: none"> <li>* The battery has run down.</li> </ul>	<ul style="list-style-type: none"> <li>* Check if there is a battery on the main board.</li> </ul>
<b>The left side printout position is incorrect</b>	<ul style="list-style-type: none"> <li>* Wrong label size setup.</li> <li>* The parameter Shift X in LCD menu is incorrect.</li> </ul>	<ul style="list-style-type: none"> <li>* Set the correct label size.</li> <li>* Press [Menu] → [Setting] → [Shift X] to fine tune the parameter of Shift X.</li> </ul>

The printing position of small label is incorrect

- \* Media sensor sensitivity is not set properly.
- \* Label size is incorrect.
- \* The parameter Shift Y in the LCD menu is incorrect.
- \* The vertical offset setting in the driver is incorrect.

- \* Calibrate the sensor sensitivity again.
- \* Set the correct label size and gap size.
- \* Press [Menu] → [Setting] → [Shift Y] → to fine tune the parameter of Shift Y.
- \* If using the software BarTender, please set the vertical offset in the driver.

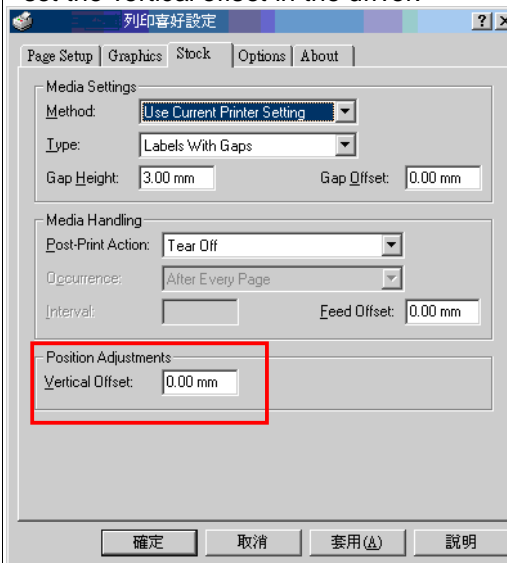

## 9. Maintenance

This session presents the clean tools and methods to maintain your printer.

1. Please use one of following material to clean the printer.
  - Cotton swab
  - Lint-free cloth
  - Vacuum / Blower brush
  - 100% Ethanol or Isopropyl Alcohol
2. The cleaning process is described as following,

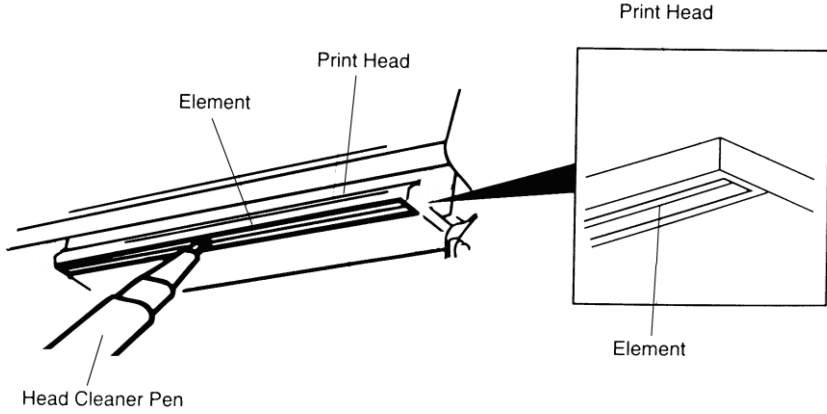
Printer Part	Method	Interval
<b>Print Head</b>	1. Always turn off the printer before cleaning the print head. 2. Allow the print head to cool for a minimum of one minute. 3. Use a cotton swab and 100% Ethanol or Isopropyl Alcohol to clean the print head surface.	Clean the print head when changing a new label roll.
		
<b>Platen Roller</b>	1. Turn the power off. 2. Rotate the platen roller and wipe it thoroughly with water.	Clean the platen roller when changing a new label roll
<b>Peel Bar</b>	Use the lint-free cloth with 100% ethanol to wipe it.	As needed
<b>Sensor</b>	Compressed air or vacuum	Monthly
<b>Exterior</b>	Wipe it with water-dampened cloth	As needed
<b>Interior</b>	Brush or vacuum	As needed

**Note:**

- Do not touch printer head by hand. If you touch it careless, please use ethanol to clean it.
- Please use 100% Ethenol or Isopropyl Alcohol. DO NOT use medical alcohol, which may damage the printer head.
- Regularly clean the print head and supply sensors once change a new media to keep printer performance and extend printer life.

## Revise History

Date	Content	Editor
2017/7/20	Add Ch.3.4.3 Loading Media in Peel-off Mode (Option for MH240P Series)	Kate
2017/8/15	Revise Ch.1.2.2 Option Card (GPIO + Parallel) from factory option to dealer option.	Kate
2017/8/25	Add Ch.1.2.2 Paper thickness of Regular cutter. Add Ch.1.2.2 User option Peel-off module assembly.	Kate
2017/11/16	Add Ch.1.2.2 minimum label peeling height on peel-off module assembly.	Kate
2018/6/26	Revise Ch.2.3.1 LED Indication and Keys	Kate
2018/9/26	Revise Maintenance chapter	Kate
2018/10/4	Revise Ch.1.2.1 Gap transmissive sensor and Black mark reflective sensor position adjustable range	Kate
2018/11/12	Revise Ch. 2.3 Operator Control Delete Ch. 2.3.3 Touch Screen Add Ch. 6 LCD Menu Function for MH240 Series Add Ch.7 LCD Menu Function for MH240T/ MH240P Series (touch panel)	Kate
2019/1/29	Revise Ch. 2.3.2 Ribbon capacity unit from % to m. Revise Ch. 6.3.2 Reprint Mode default to Disable. Add Ch.6.6 Touchscreen Calibration function. Revise Ch. 6.6 Ribbon Low Warning description. Add Ch.6.6 Favorites Lock and Favorites Password on Security. Revise Ch. 6.6 Ribbon Low Warning description. Revise Ch. 7.6 Ribbon Low Warning description. Revise MH240/MH240T/MH240P Series main screen Ribbon capacity icon.	Kate
2019/3/28	Revise Ch.1.2.1 Printer Standard Features interface from Internal Ethernet to Internal Ethernet print server (10/100 Mbps)	Kate
2019/4/17	Revise Ch.1.2.2 Option Card (GPIO + Parallel) from Dealer option to Factory option Revise Ch.1.2.2 Peel-off module assembly from User option to Dealer option Revise Ch.1.2.2 Regular cutter (Guillotine cutter) from User option to Dealer option Revise the description of Ch.1.2.2 Heavy duty cutter to MH240/MH240T Series only Add Ch.1.6 Media thickness description to 0.06 mm ~ 0.28 mm (2.36 ~ 11 mil)	Kate
2019/4/18	Revise Ch.1.2.2 Regular cutter (Guillotine cutter) spec. from Paper thickness to Media thickness Add Ch.1.2.2 Media type of Regular cutter (Guillotine cutter) and Heavy duty cutter	
2019/4/25	Add Ch.1.2.2 options for cutter tray and care label cutter.	Kate
2019/5/2	Add Ch.1.2.2 Regular cutter, Heavy duty cutter, and Care label cutter spec.	Kate
2019/6/14	Revise Ch. 1.2.1 Printer Standard Features for MH240/ MH340/ MH640 Series SDRAM from 128MB to 256MB Revise Ch. 1.2.1 Printer Standard Features for MH240/ MH340/ MH640 Series Flash memory from 128MB to 512MB Add Ch. 1.6 Media types with perforated, tag, and care label (outside wound)	Kate
2019/6/18	Revise Ch.2.3.2 Indicated icons	Kate

	Add Ch.2.3.2 TPH cleaning icon description	
2019/9/27	Revise CCC certification logo	Kate



TSC Auto ID Technology Co., Ltd.

Corporate Headquarters

9F., No.95, Minquan Rd., Xindian Dist.,  
New Taipei City 23141, Taiwan (R.O.C.)  
TEL: +886-2-2218-6789  
FAX: +886-2-2218-5678  
Web site: [www.tscprinters.com](http://www.tscprinters.com)  
E-mail: [apac\\_sales@tscprinters.com](mailto:apac_sales@tscprinters.com)  
[tech\\_support@tscprinters.com](mailto:tech_support@tscprinters.com)

Li Ze Plant

No.35, Sec. 2, Ligong 1st Rd., Wujie Township,  
Yilan County 26841, Taiwan (R.O.C.)  
TEL: +886-3-990-6677  
FAX: +886-3-990-5577