

ME240/ ME340

**THERMAL TRANSFER / DIRECT THERMAL
BAR CODE PRINTER**

**USER'S
MANUAL**

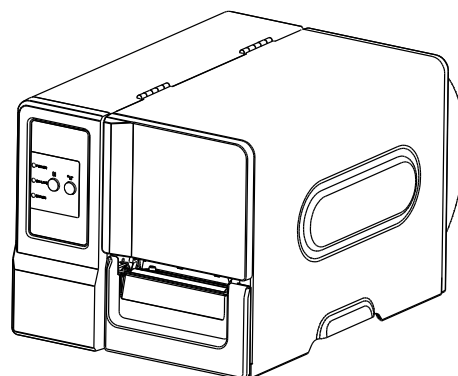

Copyright Information

©2011 TSC Auto ID Technology Co., Ltd,

The copyright in this manual, the software and firmware in the printer described therein are owned by TSC Auto ID Technology Co., Ltd, All rights reserved.

CG Triumvirate is a trademark of Agfa Corporation. CG Triumvirate Bold Condensed font is under license from the Monotype Corporation. Windows is a registered trademark of Microsoft Corporation.

All other trademarks are the property of their respective owners.

Information in this document is subject to change without notice and does not represent a commitment on the part of TSC Auto ID Technology Co. No part of this manual may be reproduced or transmitted in any form or by any means, for any purpose other than the purchaser's personal use, without the expressed written permission of TSC Auto ID Technology Co.

Agency Compliance and Approvals



EN 55032, Class A
EN 55024
EN 60950-1; EN 61000-3-2; EN 61000-3-3

This is a class A product. In a domestic environment this product may cause radio interference in which case the user may be required to take adequate measures.



FCC part 15B, Class A
ICES-003, Class A

This equipment has been tested and found to comply with the limits for a Class A digital device, pursuant to Part 15 of the FCC Rules. These limits are designed to provide reasonable protection against harmful interference when the equipment is operated in a commercial environment.

This equipment generates, uses, and can radiate radio frequency energy and, if not installed and used in accordance with the manufacturer's instruction manual, may cause harmful interference with radio communications. Operation of this equipment in a residential area is likely to cause harmful interference, in which case you will be required to correct the interference at your own expense.

This Class A digital apparatus complies with Canadian ICES-003.
Cet appareil numérique de la classe A est conforme à la norme NMB-003 du Canada.

This device complies with Part 15 of the FCC Rules. Operation is subject to the following two conditions: (1) This device may cause harmful interference, and (2) this device must accept any interference received, including interference that may cause undesired operation.



AS/NZS CISPR 32, Class A



UL 60950-1(2nd Edition)
CSA C22.2 No. 60950-1-07(2nd Edition)



KN 22
KN 24

이 기기는 업무용(A 급) 전자파적합기기로서 판매자 또는 사용자는 이 점을 주의하시기 바라며, 가정외의 지역에서 사용하는 것을 목적으로 합니다.



GB 4943.1
GB 9254, Class A
GB 17625.1

此为 A 级产品，在生活环境中，该产品可能会造成无线电干扰，在这种情况下，可能需要用户对干扰采取切实可行的措施。



EN 60950-1



IS 13252(Part 1)/
IEC 60950-1



TP TC 004/2011
TP TC 020/2011

Note: There may have certification differences in the series models, please refer to product label for accuracy.

Important safety instructions:

1. Read all of these instructions and keep them for later use.
2. Follow all warnings and instructions on the product.
3. Disconnect the power plug from the AC outlet before cleaning or if fault happened.
Do not use liquid or aerosol cleaners. Using a damp cloth is suitable for cleaning.
4. The mains socket shall be installed near the equipment and easily accessible.
5. The unit must be protected against moisture.
6. Ensure the stability when installing the device, Tipping or dropping could cause damage.
7. Make sure to follow the correct power rating and power type indicated on marking label provided by manufacture.
8. Please refer to user manual for maximum operation ambient temperature.

WARNING:

Hazardous moving parts, keep fingers and other body parts away.

CAUTION:

(For equipment with RTC (CR2032) battery or rechargeable battery pack)

Risk of explosion if battery is replaced by an incorrect type.

Dispose of used batteries according to the Instructions as below.

1. DO NOT throw the battery in fire.
2. DO NOT short circuit the contacts.
3. DO NOT disassemble the battery.
4. DO NOT throw the battery in municipal waste.
5. The symbol of the crossed out wheeled bin indicates that the battery should not be placed in municipal waste.



Caution: The printhead may be hot and could cause severe burns. Allow the printhead to cool.

CAUTION:

Any changes or modifications not expressly approved by the grantee of this device could void the user's authority to operate the equipment.

BSMI Class A 警語:

這是甲類的資訊產品，在居住的環境使用中時，可能會造成射頻干擾，在這種情況下，使用者會被要求採取某些適當的對策。

型號	解析度	列印速度
ME240 系列	200 dpi	1.5, 2, 3, 4, 5, 6 ips
ME340 系列	300 dpi	1.5, 2, 3, 4, ips

設備名稱 Equipment name：熱轉式/熱感式條碼印表機，
 型號（型式） Type designation (Type)：ME240 系列

單元 Unit	限用物質及其化學符號 Restricted substances and its chemical symbols					
	鉛Lead (Pb)	汞Mercury (Hg)	鎘Cadmium (Cd)	六價鉻 Hexavalent chromium (Cr ⁺⁶)	多溴聯苯 Polybrominated biphenyls (PBB)	多溴二苯醚 Polybrominated diphenyl ethers (PBDE)
內外塑膠件	○	○	○	○	○	○
內外鐵件	-	○	○	○	○	○
滾輪	○	○	○	○	○	○
銘版	○	○	○	○	○	○
電路板	-	○	○	○	○	○
晶片電阻	-	○	○	○	○	○
積層陶瓷表面 黏著電容	○	○	○	○	○	○
集成電路-IC	-	○	○	○	○	○
電源供應器	○	○	○	○	○	○
印字頭	○	○	○	○	○	○
馬達	-	○	○	○	○	○
液晶顯示器	-	○	○	○	○	○
插座	-	○	○	○	○	○
線材	-	○	○	○	○	○

備考1. “超出0.1 wt %” 及 “超出0.01 wt %” 係指限用物質之百分比含量超出百分比含量基準值。
 Note 1: “Exceeding 0.1 wt %” and “exceeding 0.01 wt %” indicate that the percentage content of the restricted substance exceeds the reference percentage value of presence condition.

備考2. “○” 係指該項限用物質之百分比含量未超出百分比含量基準值。
 Note 2: “○” indicates that the percentage content of the restricted substance does not exceed the percentage of reference value of presence.

備考3. “-” 係指該項限用物質為排除項目。
 Note 3: The “-” indicates that the restricted substance corresponds to the exemption.

Contents

1. Introduction	1
1.1 Product Introduction	1
1.2 Product Features	2
1.2.1 Printer standard features	2
1.2.2 Printer optional features	3
1.3 General Specifications	4
1.4 Print Specifications	4
1.5 Ribbon Specifications	4
1.6 Media Specifications	5
2. Operations Overview	6
2.1 Unpacking and Inspection	6
2.2 Printer Overview	7
2.2.1 Front View	7
2.2.2 Interior view	8
2.2.3 Rear View	9
2.3 Operator Controls	11
2.3.1 Front Panel & Keys	11
2.3.2 LED Indicators	13
2.4 Setting up the Printer	13
2.5 Installation of Ribbon	14
2.5.1 Loading the Ribbon	14
2.6 Installation of Media	17
2.6.1 Loading the Roll Label	17
2.6.2 Loading the Fan-fold Label	21
2.6.3 Loading the Media in Peel-off Mode (Option)	22
2.6.4 Loading the Media in Cutter Mode (Option)	24
2.7 Print Head Pressure Adjustment Knob	25
3. LCD Panel Menu Function (Option)	26
3.1 Setup Menu Overview	27
3.1.1-1 Printer Setup (TSPL2)	28
3.1.1-2 Printer Setup (ZPL2)	35
3.1.2 Sensor	41
3.1.3 Serial Comm.	50
3.1.4 Ethernet	52
3.2 File Manager	56

3.2.1 File List	56
3.2.2 Avail. Memory	57
3.2.3 Del. All Files	57
3.3 Diagnostics	58
3.3.1 Print Config.	58
3.3.2 Dump Mode	58
3.3.3 Rotate Cutter	59
3.4 Language	59
3.5 Service	60
3.5.1 Initialization	60
3.5.2 Mileage Info.	60
4. Diagnostic Tool	61
4.1 Start the Diagnostic Tool.....	61
4.2 Printer Function	62
5 Setting Ethernet by Diagnostic Utility (Option)	67
5.1 Using USB interface to setup Ethernet interface.....	67
5.2 Using RS-232 interface to setup Ethernet interface	68
5.3 Using Ethernet interface to setup Ethernet interface	69
6. Troubleshooting	71
6.1 Common Problems	71
6.2 Mechanism Fine Adjustment to Avoid Ribbon Wrinkles	75
7. Maintenance	77
Revise History	78

1. Introduction

1.1 Product Introduction

Thank you very much for purchasing TSC bar code printer.

TSC ME240 series of industrial thermal label printers is designed to offer the right features at the best value in the industry. The ME240 series features a small footprint and low profile design that fits where larger industrial printers do not.

Its quiet operation and fast label throughput is equally at home, in the office or shop floor environment. The printers all-metal construction and die-cast aluminum print mechanism engine is durable enough to withstand the toughest production environments.

The moveable sensor design can accept wide range of label media. All of the most frequently used bar code formats are included. Fonts and bar codes can be printed in any one of the four directions.

This printer is built-in the high quality, high performance MONOTYPE IMAGING® True Type font engine and one CG Triumvirate Bold Condensed smooth font. With flexible firmware design, user can also download the True Type Font from PC into printer memory for printing labels. Besides the scalable font, it also provides a choice of five different sizes of alphanumeric bitmap font, OCR-A and OCR-B fonts. By integrating rich features, it is the most cost-effective and high performance printer in its class!

To print label formats, please refer to the instructions provided with your labeling software; if you need to write the custom programs, please refer to the TSPL/TSPL2 programming manual that can be found in the accessories CD-ROM or on TSC website at <http://www.tscprinters.com>

- Applications
 - Compliance labeling for shipping and receiving
 - Pallet labeling
 - Inventory control labeling
 - Drum labeling
 - Warning labels
 - Custom signage
 - Brand marketing featuring graphics, logos and texts
 - Multiple-up labels (two or three labels across)

1.2 Product Features

1.2.1 Printer standard features

The printer offers the following standard features.

Product standard feature	203 dpi models	300 dpi models
Thermal transfer printing	<input type="radio"/>	<input type="radio"/>
Direct thermal printing	<input type="radio"/>	<input type="radio"/>
Die-cast based print mechanism	<input type="radio"/>	<input type="radio"/>
Metal cover with large clear media view window	<input type="radio"/>	<input type="radio"/>
Position adjustable gap sensor	<input type="radio"/>	<input type="radio"/>
Position adjustable black mark sensor	<input type="radio"/>	<input type="radio"/>
Ribbon end sensor	<input type="radio"/>	<input type="radio"/>
Ribbon encoder sensor	<input type="radio"/>	<input type="radio"/>
LED indicators	<input type="radio"/>	<input type="radio"/>
Real time clock	<input type="radio"/>	<input type="radio"/>
USB 2.0 (full speed) interface	<input type="radio"/>	<input type="radio"/>
Serial RS-232C (2400-115200 bps) interface	<input type="radio"/>	<input type="radio"/>
8 MB SDRAM memory	<input type="radio"/>	<input type="radio"/>
4 MB FLASH memory	<input type="radio"/>	<input type="radio"/>
SD FLASH memory card reader for memory expansion up to 4 GB	<input type="radio"/>	<input type="radio"/>
Standard industry emulations right out of the box including Eltron® and Zebra® language support	<input type="radio"/>	<input type="radio"/>
Internal 8 alpha-numeric bitmap fonts	<input type="radio"/>	<input type="radio"/>
Fonts and bar codes can be printed in any one of the four directions (0, 90,180, 270 degree)	<input type="radio"/>	<input type="radio"/>
Internal Monotype Imaging® true type font engine with one CG Triumvirate Bold Condensed scalable font	<input type="radio"/>	<input type="radio"/>
Downloadable fonts from PC to printer memory	<input type="radio"/>	<input type="radio"/>
Downloadable firmware upgrades	<input type="radio"/>	<input type="radio"/>

Text, bar code, graphics/image printing (Please refer to the TSPL/TSPL2 programming manual for supporting code page)		○	○									
<table border="1"> <thead> <tr> <th colspan="2">Supported bar code</th> <th>Supported image</th> </tr> <tr> <th>1D bar code</th> <th>2D bar code</th> <th></th> </tr> </thead> <tbody> <tr> <td>Code 39, Code 93, Code128UCC, Code128 subsets A.B.C, Codabar, Interleave 2 of 5, EAN-8, EAN-13, EAN-128, UPC-A, UPC-E, EAN and UPC 2(5) digits add-on, MSI, PLESSEY, POSTNET, China POST, GS1 DataBar, Code 11, Logmars</td> <td>PDF-417, Maxicode, DataMatrix, QR code, Aztec</td> <td>BITMAP, BMP, PCX (Max. 256 colors graphics)</td> </tr> </tbody> </table>		Supported bar code		Supported image	1D bar code	2D bar code		Code 39, Code 93, Code128UCC, Code128 subsets A.B.C, Codabar, Interleave 2 of 5, EAN-8, EAN-13, EAN-128, UPC-A, UPC-E, EAN and UPC 2(5) digits add-on, MSI, PLESSEY, POSTNET, China POST, GS1 DataBar, Code 11, Logmars	PDF-417, Maxicode, DataMatrix, QR code, Aztec	BITMAP, BMP, PCX (Max. 256 colors graphics)		
Supported bar code		Supported image										
1D bar code	2D bar code											
Code 39, Code 93, Code128UCC, Code128 subsets A.B.C, Codabar, Interleave 2 of 5, EAN-8, EAN-13, EAN-128, UPC-A, UPC-E, EAN and UPC 2(5) digits add-on, MSI, PLESSEY, POSTNET, China POST, GS1 DataBar, Code 11, Logmars	PDF-417, Maxicode, DataMatrix, QR code, Aztec	BITMAP, BMP, PCX (Max. 256 colors graphics)										

1.2.2 Printer optional features

The printer offers the following optional features.

Product option feature	User options	Dealer options	Factory options
LCD display (graphic type, 128x64 pixel) with back light (for basic model only)	-	-	○
Internal Ethernet print server (10/100 Mbps) interface	-	-	○
USB host (Support PC keyboard and bar code scanner)	-	-	○
Centronics interface	-	-	○
Peel-off module	-	○	-
Regular guillotine cutter Media thickness: 0.06~ 0.25mm Media type: receipt, tag, and label liner w/o glue Note: Except for the linerless cutter, all regular/heavy duty/care label cutters DO NOT cut on media with glue.	-	○	-
Bluetooth module (RS-232C interface)	○	-	-
KP-200 Plus keyboard display unit	○	-	-
KU-007 Plus programmable smart keyboard display unit	○	-	-
HCS-200 long rang CCD scanner	○	-	-

1.3 General Specifications

General Specifications	
Physical dimensions	286 mm (W) x 259 mm (H) x 434 mm (D)
Weight	11 kg
Electrical	Internal switching power supply Input: AC 100-240V Output: DC 24V 3.3A
Environmental condition	Operation: 5 ~ 40°C (41 ~ 104°F), 25~85% non-condensing Storage: -40 ~ 60 °C (-40 ~ 140°F), 10~90% non-condensing

1.4 Print Specifications

Print Specifications	203 dpi models	300 dpi models
Print head resolution	203 dots/inch (8 dots/mm)	300 dots/inch (12 dots/mm)
Printing method	Thermal transfer and direct thermal	
Dot size (width x length)	0.125 x 0.125 mm (1 mm = 8 dots)	0.084 x 0.084 mm (1 mm = 11.8 dots)
Print speed (inches per second)	Up to 6 ips	Up to 4 ips
Max. print width	104 mm (4.09")	
Max. print length	2,286 mm (90")	1,016 mm (40")

1.5 Ribbon Specifications

Ribbon Specifications	
Ribbon outside diameter	Max. 81.3 mm
Ribbon length	450 meter
Ribbon core inside diameter	1 inch (25.4 mm)
Ribbon width	Max. 110 mm
	Min. 40 mm
Ribbon wound type	Outside wound

1.6 Media Specifications

Media Specifications	203 dpi models	300 dpi models
Label roll capacity	203.2 mm (8") OD	
Media alignment	Edge alignment	
Media type	Continuous, die-cut, black mark, fan-fold, notch	
Media wound type	Printing face outside wound	
Media width (label + liner)	Max. 118 mm (4.6")	
	Min. 25.4 mm (1.0")	
Media thickness (label + liner)	Max. 0.28 mm (11 mil)	
	Min. 0.06 mm (2.36 mil)	
Media core diameter	25.4 mm~76.2 mm (1"~3")	
Label length	5~2,286 mm (0.2"~90")	5~1,016 mm (0.2"~40")
Label length (peeler mode)	Max. 152.4 mm (6")	
	Min. 25.4 mm (1")	
Label length (cutter mode)	Max. 2,286 mm (90")	Max. 1,016 mm (40")
	Min. 25.4 mm (1")	Min. 25.4 mm (1")
Gap height	Min. 2 mm	
Black mark height	Min. 2 mm	
Black mark width	Min. 8 mm (0.31")	

2. Operations Overview

2.1 Unpacking and Inspection

This printer has been specially packaged to withstand damage during shipping. Please carefully inspect the packaging and printer upon receiving the bar code printer. Please retain the packaging materials in case you need to reship the printer.

Unpacking the printer, the following items are included in the carton.

- One printer unit
- One Windows labeling software/Windows driver CD disk
- One quick installation guide
- One power cord
- One USB interface cable
- One ribbon take up paper core

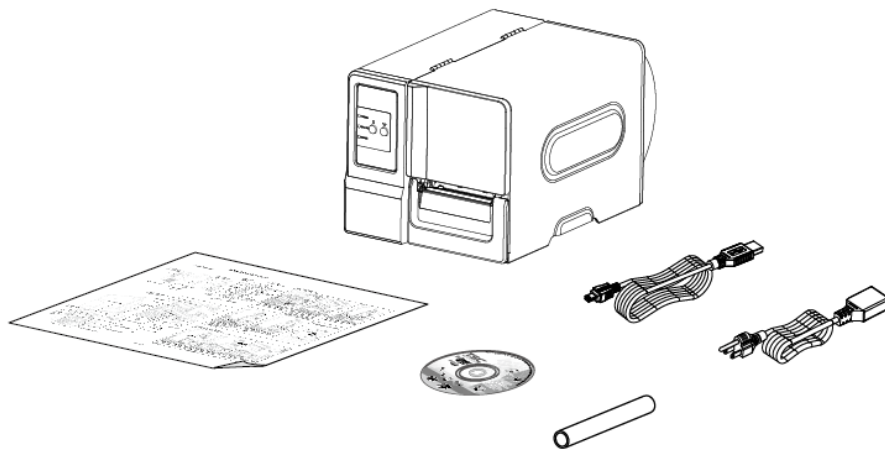

If any parts are missing, please contact the Customer Service Department of your purchased reseller or distributor.

2.2 Printer Overview

2.2.1 Front View



1. LED indicators
2. Pause key
3. Feed key
4. Paper exit chute
5. Lower front cover
6. Media viewer
7. Printer right side cover opener
8. LCD (Option)
9. Keys for LCD module (Option)

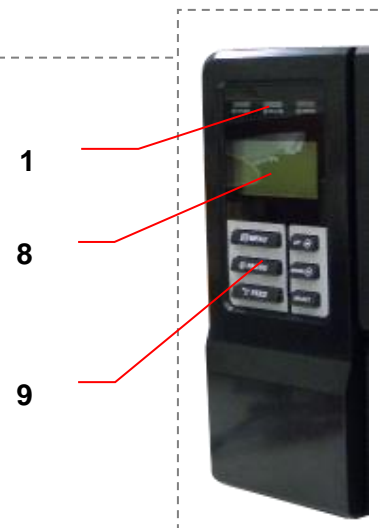

2.2.2 Interior view

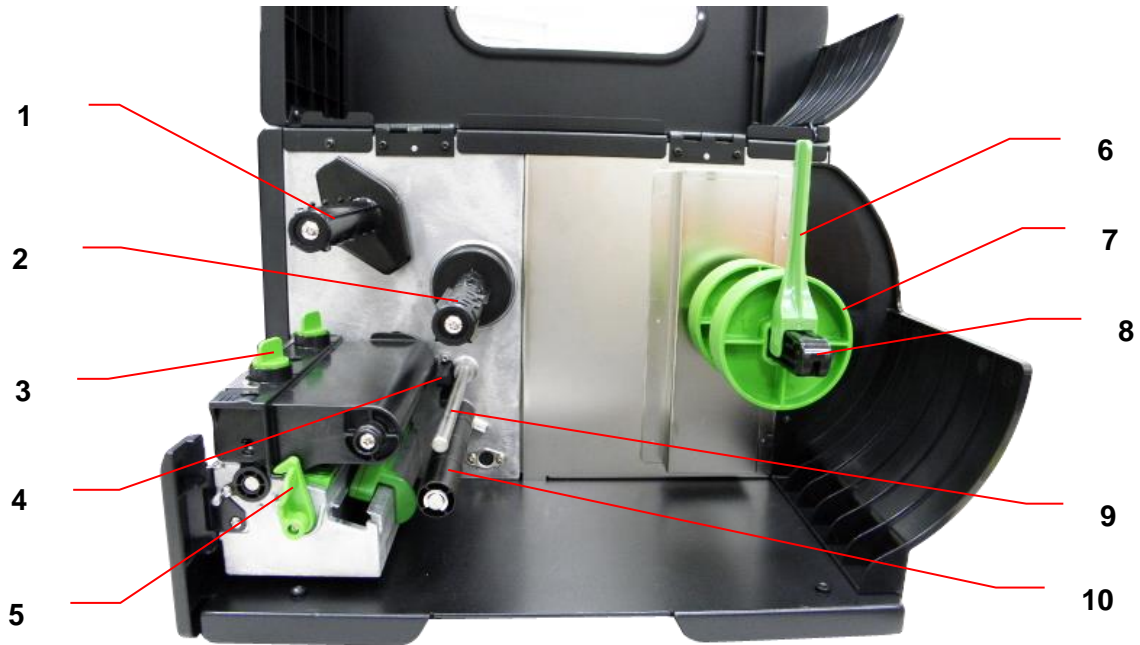

1. Ribbon rewind spindle
2. Ribbon supply spindle
3. Print head pressure adjustment knob
4. Ribbon end sensor
5. Print head release lever
6. Label roll guard
7. 3" core adapter
8. Label supply spindle
9. Ribbon guide bar
10. Media guide bar
11. Print head
12. Platen roller
13. Media sensor
14. Label guide

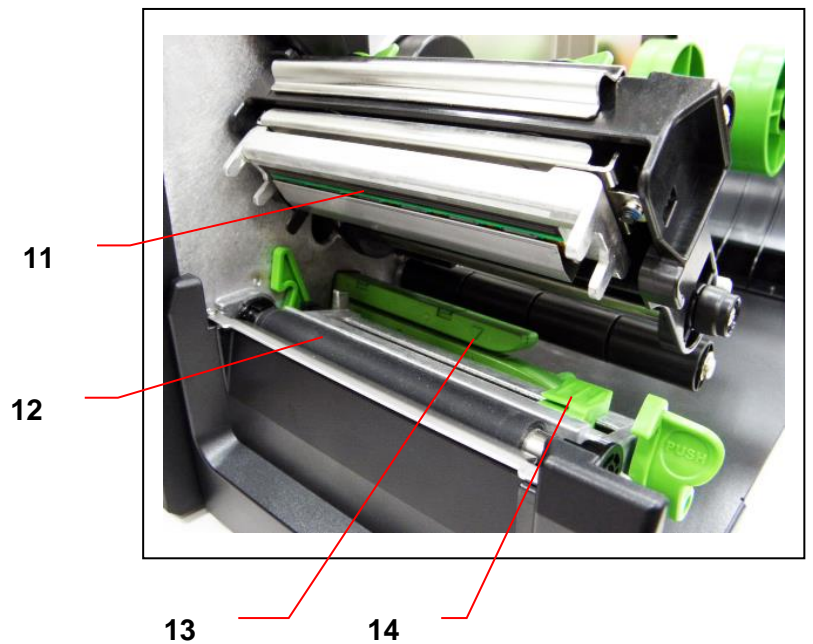

2.2.3 Rear View

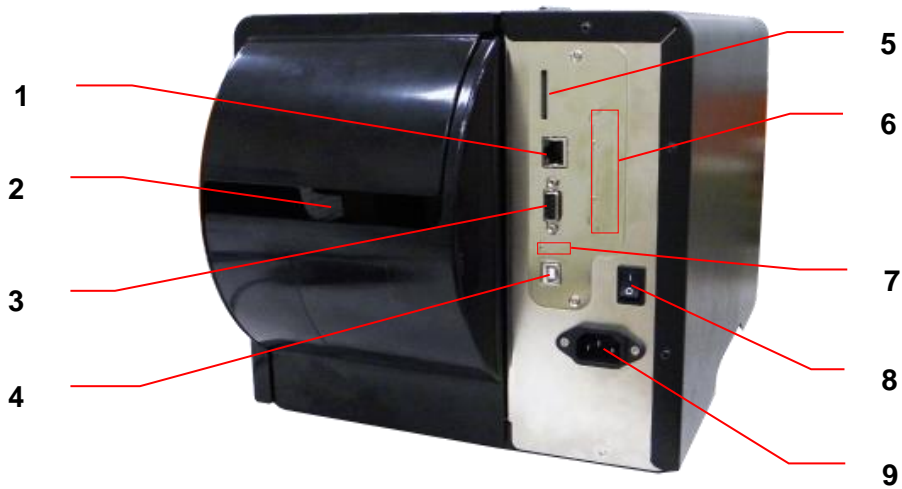

1. Internal Ethernet interface (Option)
2. Fan-fold paper entrance chute
3. RS-232C interface (Max. 115,200 bps)
4. USB interface (USB 2.0/ Full speed mode)
- *5. SD card slot
6. Centronics interface (Option)
7. USB host (Option)
8. Power switch
9. Power jack socket

Note:

The interface picture here is for reference only. Please refer to the product specification for the interfaces availability.

* Recommended SD card specification

SD card spec	SD card capacity	Approved SD card manufacturer
V1.0, V1.1	128 MB	SanDisk, Transcend
V1.0, V1.1	256 MB	SanDisk, Transcend, Panasonic
V1.0, V1.1	512 MB	SanDisk, Transcend, Panasonic
V1.0, V1.1	1 GB	SanDisk, Transcend, Panasonic
V2.0 SDHC CLASS 4	4 GB	
V2.0 SDHC CLASS 6	4 GB	SanDisk, Transcend, Panasonic
V1.0, V1.1	microSD 128 MB	Transcend, Panasonic
V1.0, V1.1	microSD 256 MB	Transcend, Panasonic
V1.0, V1.1	microSD 512 MB	Panasonic
V1.0, V1.1	microSD 1 GB	Transcend, Panasonic

V2.0 SDHC CLASS 4	microSD 4 GB	Panasonic
V2.0 SDHC CLASS 6	microSD 4 GB	Transcend
V1.0, V1.1	miniSD 128 MB	Transcend, Panasonic
V1.0, V1.1	miniSD 256 MB	Transcend, Panasonic
V1.0, V1.1	miniSD 512 MB	Transcend, Panasonic
V1.0, V1.1	miniSD 1 GB	Transcend, Panasonic
V2.0 SDHC CLASS 4	miniSD 4 GB	Transcend
V2.0 SDHC CLASS 6	miniSD 4 GB	



- The DOS FAT file system is supported for the SD card.
- Folders/files stored in the SD card should be in the 8.3 filename format
- The miniSD/microSD card adapter is required for SD card reader.

2.3 Operator Controls

2.3.1 Front Panel & Keys

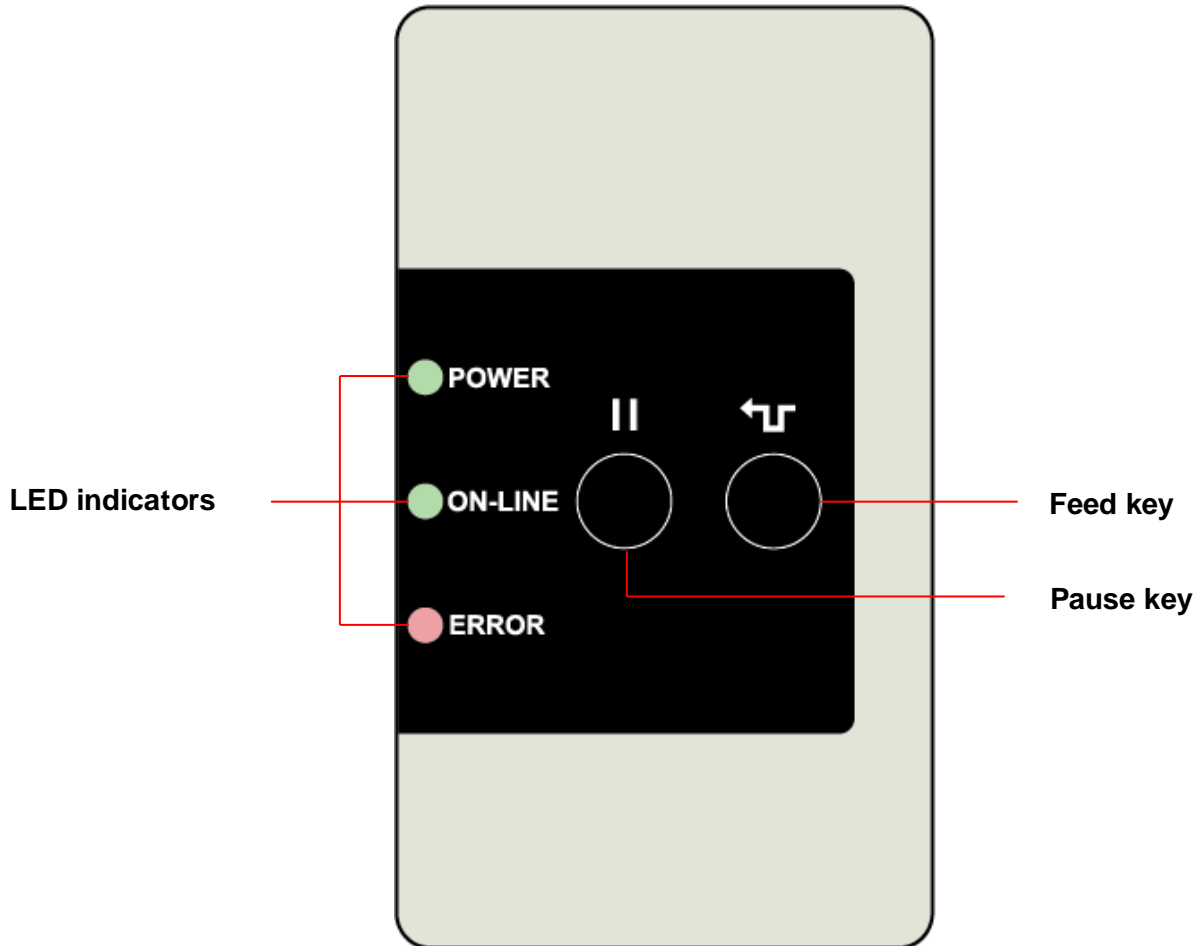



Standard

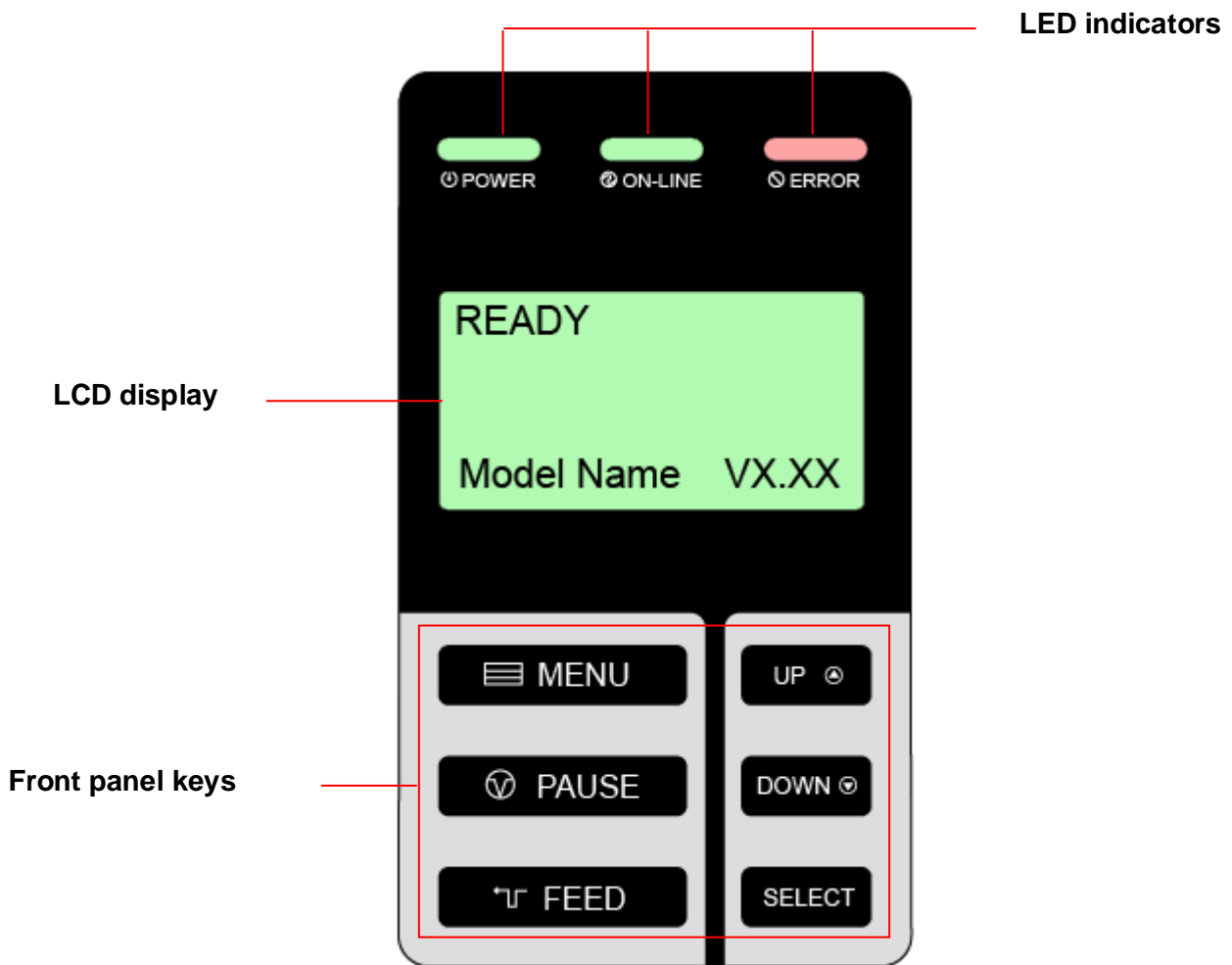

Keys	Function
 Feed key	Advance one label
 Pause key	Pause/Resume the printing process

Option



Keys	Function
 MENU	1. Enter the menu 2. Exit from a menu or cancel a setting and return to the previous menu
 PAUSE	Pause/Resume the printing process
 FEED	Advance one label
UP 	Scroll up the menu list
DOWN 	Scroll down the menu list
SELECT	Enter/select cursor located option

2.3.2 LED Indicators

LED	Status	Indication
POWER	Off	The printer power is turned off
	On	The printer power is turned on
ON-LINE	On	Printer is ready
	Blinking	Pause
		Downloading data into printer
ERROR	Off	Printer is ready
	On	“Carriage open”, “Cutter error” or “Clearing data”
	Blinking	“No paper”, “Paper jam” or “No ribbon”

2.4 Setting up the Printer

1. Place the printer on a flat, secure surface.
2. Make sure the power switch is off.
3. Connect the printer to the computer with the provided USB cable.
4. Plug the power cord into the AC power cord socket at the rear of the printer, and then plug the power cord into a properly grounded power outlet.

Note:

Please switch OFF printer power switch prior to plug in the power cord to printer power jack.

2.5 Installation of Ribbon

2.5.1 Loading the Ribbon



1. Open the printer right side cover.



2. Install the ribbon and paper core onto the ribbon supply spindle and ribbon rewind spindle. Push the paper core and ribbon roll to the end of the spindle.

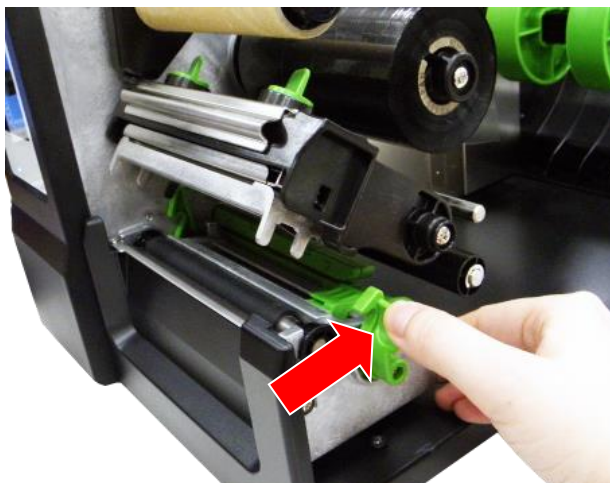

3. Push the print head release lever to open the print head mechanism.

	<p>4. Thread the ribbon leader through the slot between ribbon sensor and ribbon guide bar until ribbon passes through the print head and place the ribbon leader onto the ribbon rewind spindle.</p> <p>Ribbon leader</p> <p>Ribbon sensor</p> <p>Ribbon guide bar</p>
	<p>5. Stick the ribbon leader onto the paper core. Keep the ribbon flat and without wrinkle.</p>
	<p>6. Rotate the ribbon rewind spindle until the ribbon leader is thoroughly, firmly encompassed by the black section of the ribbon.</p>

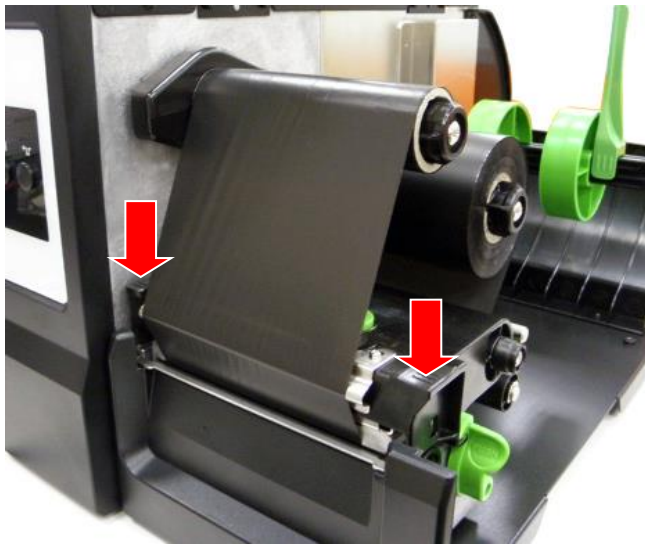

7. Close the print head mechanism. Make sure the latches are engaged securely.

● Loading path for ribbon

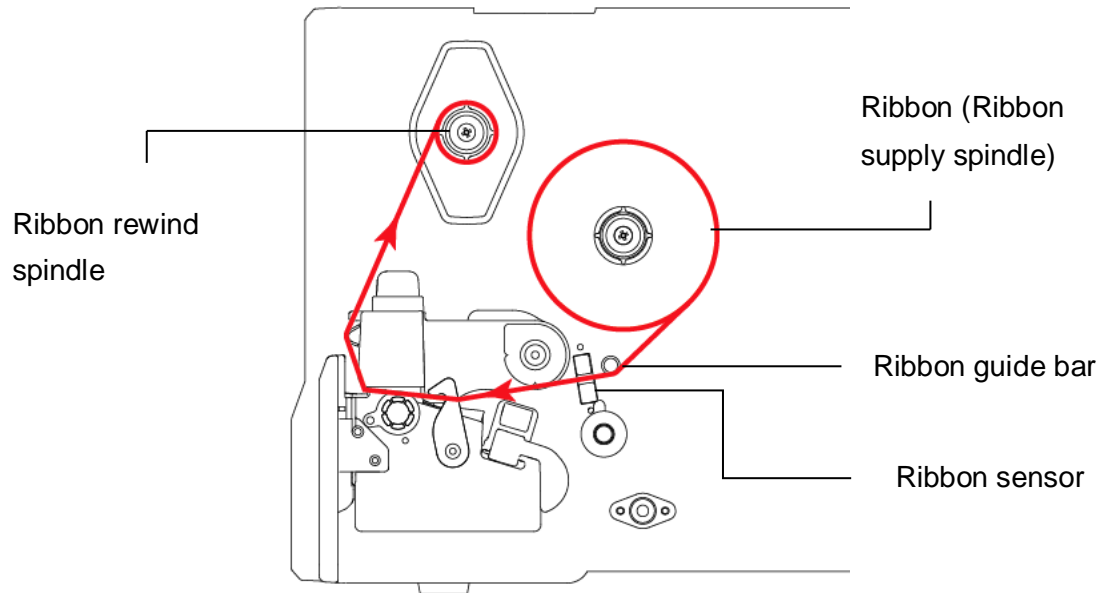

Note:

Please refer to videos on [TSC YouTube](#) or driver CD.

2.6 Installation of Media

2.6.1 Loading the Roll Label

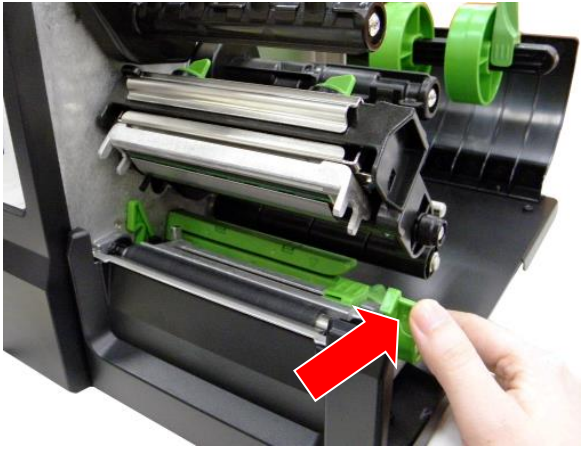
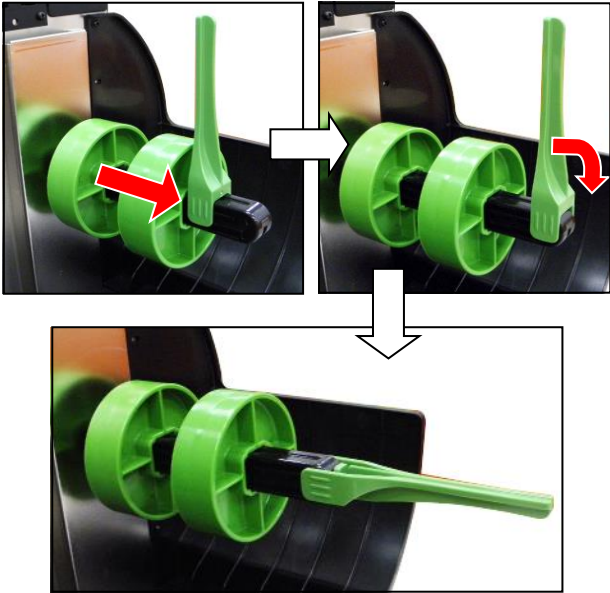
	<p>1. Open the printer right side cover.</p>
	<p>2. Push the print head release lever to open the print head mechanism.</p>
	<p>3. Move the label roll guard horizontally to the end of label spindle then flip down the label roll guard.</p>

4. Place the roll of media on the label supply spindle. Flip up the label roll guard.

Note:

When insert the 3 inch core adapter to the spindle, please making sure the arrow direction is as following fig. When using 1 inch core media, please remove the 3 inch core adapters from the label supply spindle.

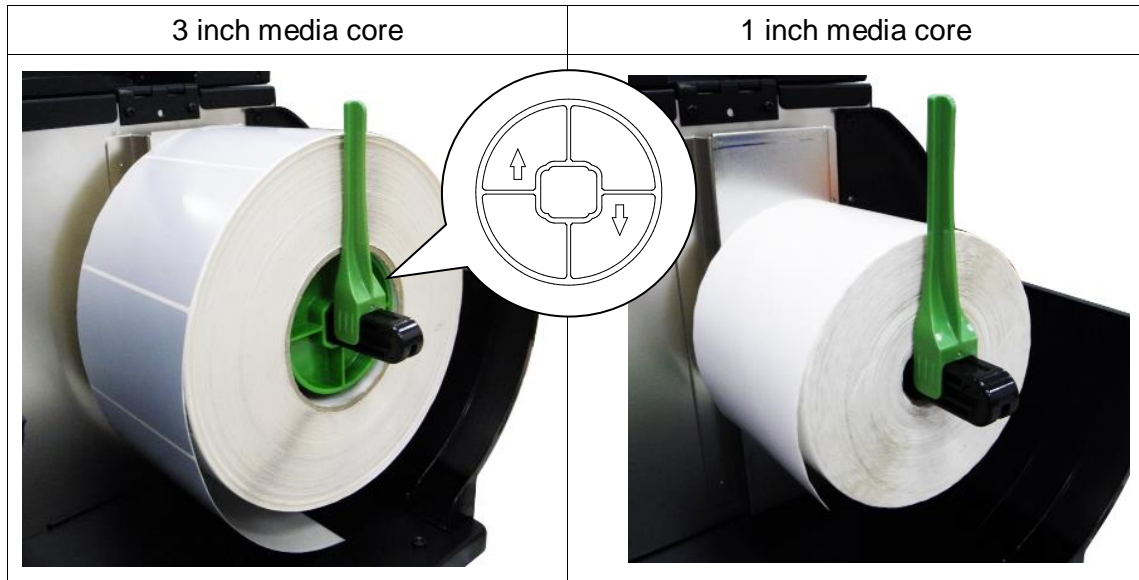

5. Pull label roll leading edge forward through the media guide bar, media sensor and place the label leading edge onto the platen roller.

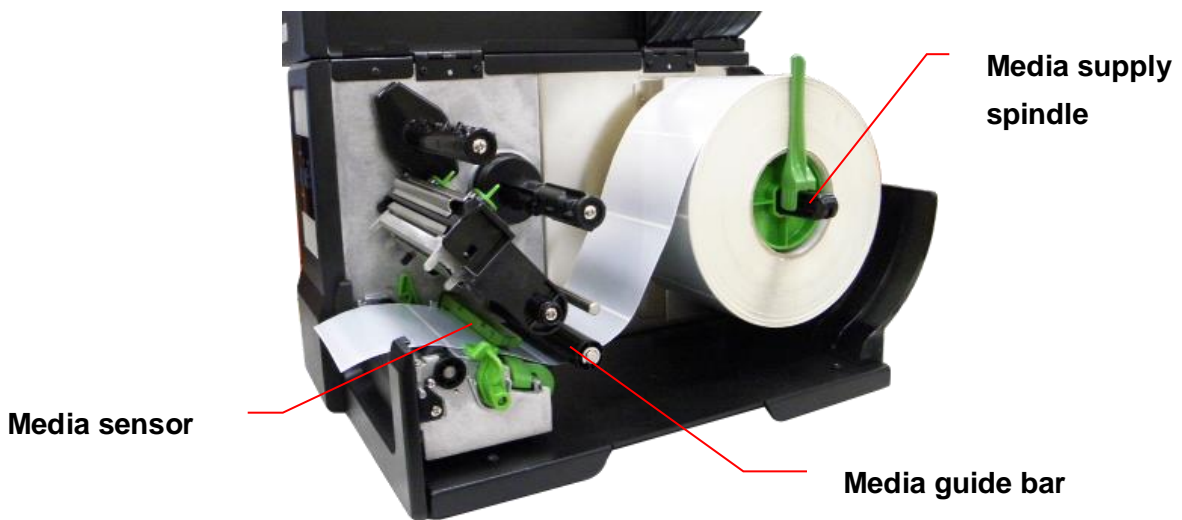

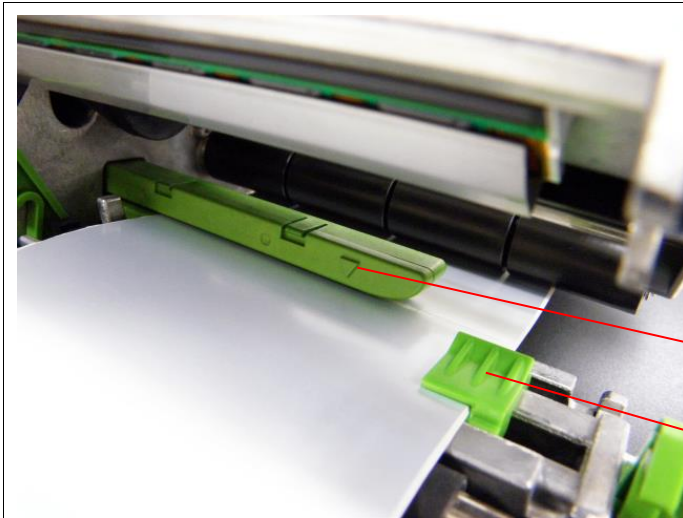

6. Adjust the label guide to fit the width of the label. Make sure the media sensor triangle indicator is on the paper feed path that can sense the gap or black or notch for label registration.

Media sensor indicator

Label guide

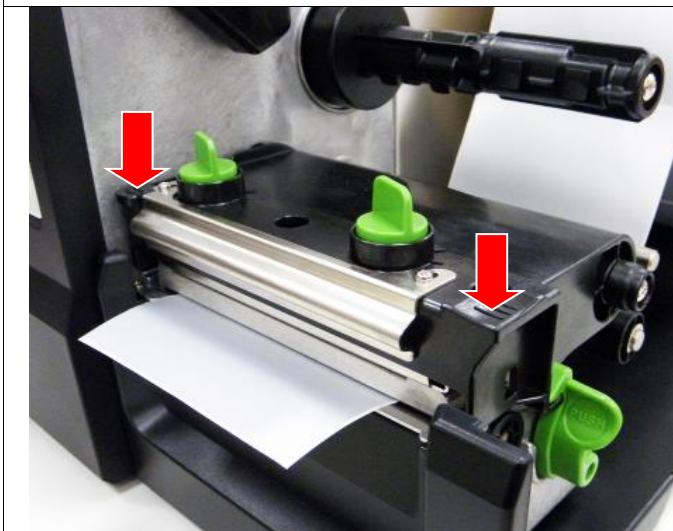

7. Close the print head mechanism. Make sure the latches are engaged securely.

8. Use the DiagTool to set the media sensor type and calibrate the selected sensor. (Please refer to section 4)

Note:

- Please calibrate the gap/black mark sensor when changing media.
- The sensor location is marked by a triangle mark ∇ at the sensor housing.
- The media sensor position is moveable. Please make sure the gap or black mark is at the location where media gap/black mark will pass through for sensing.
- Please refer to videos on [TSC YouTube](#) or driver CD.

● **Loading path for roll labels**

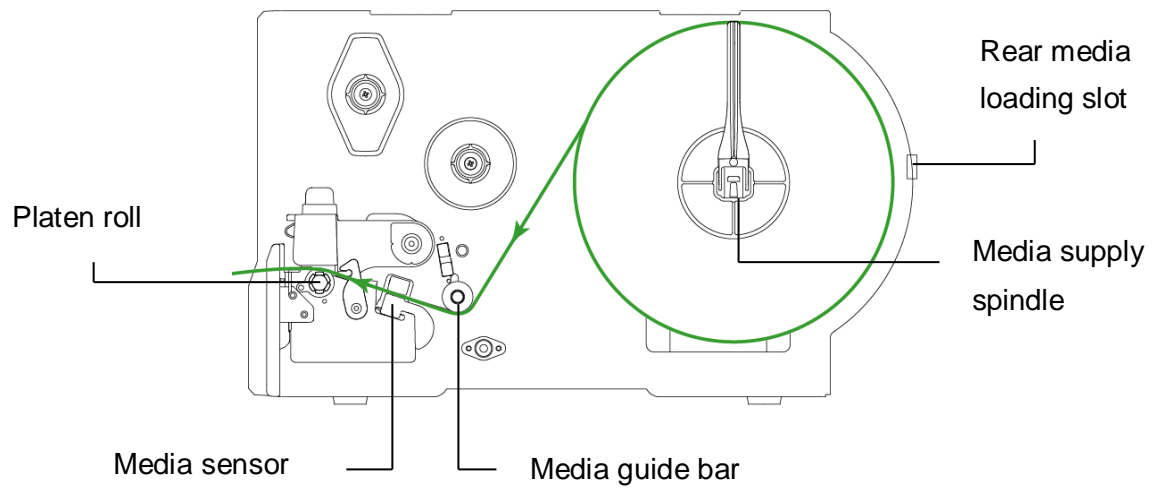

2.6.2 Loading the Fan-fold Label

Fan-fold media feeds through rear external label entrance chute.

1. Open the printer right side cover.
2. Push the print head release lever to open the print head mechanism.
3. Move the label roll guard horizontally to the end of label spindle then flip down the label roll guard.

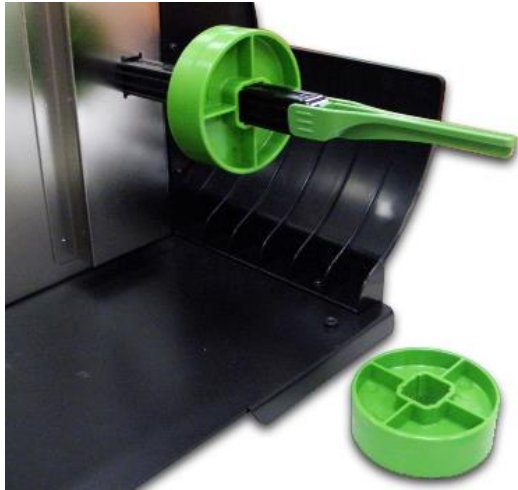

4. Remove the 3 inch core adapters from the media supply spindle.

5. Insert the fan-fold media through the rear external label entrance chute.
6. Pull fan-fold label leading edge forward through the media guide bar, media sensor and place the label leading edge onto the platen roller.
7. Adjust the label roll guard and label guide by sliding to fit the paper width.
8. Close the print head mechanism making sure the latches are engaged securely.

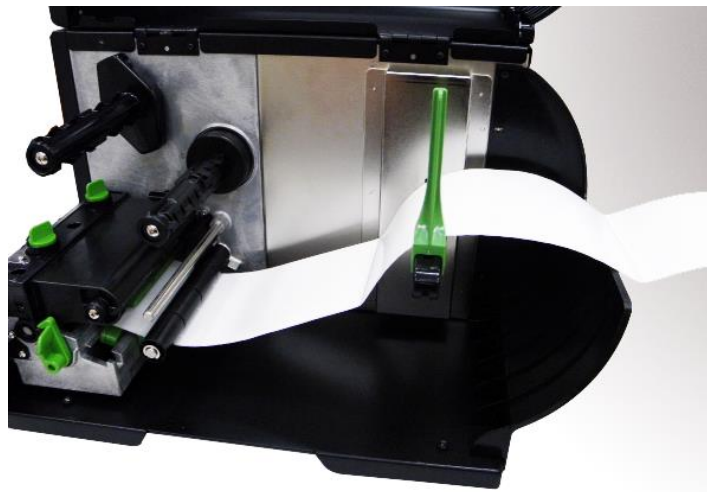

9. Set the media sensor type and calibrate the selected sensor. (Please refer to section 4)

Note:

Please calibrate the gap/black mark sensor when changing media.

2.6.3 Loading the Media in Peel-off Mode (Option)

1. Open the peel-off cover by pulling-down the tabs located on peel-off cover.

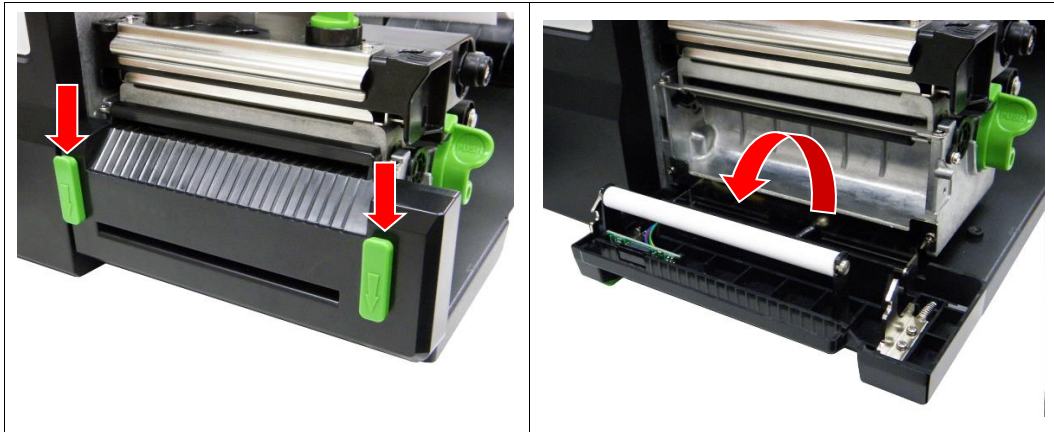

2. Refer to chapter 2.6.1 to install the label.
3. Use the DiagTool to set the media sensor type and calibrate the selected sensor.
(Please refer to chapter 4.)
4. Pull the label through the front of the printer and take some labels off only leave the liner.



5. Feed the liner into peel-off cover slot.

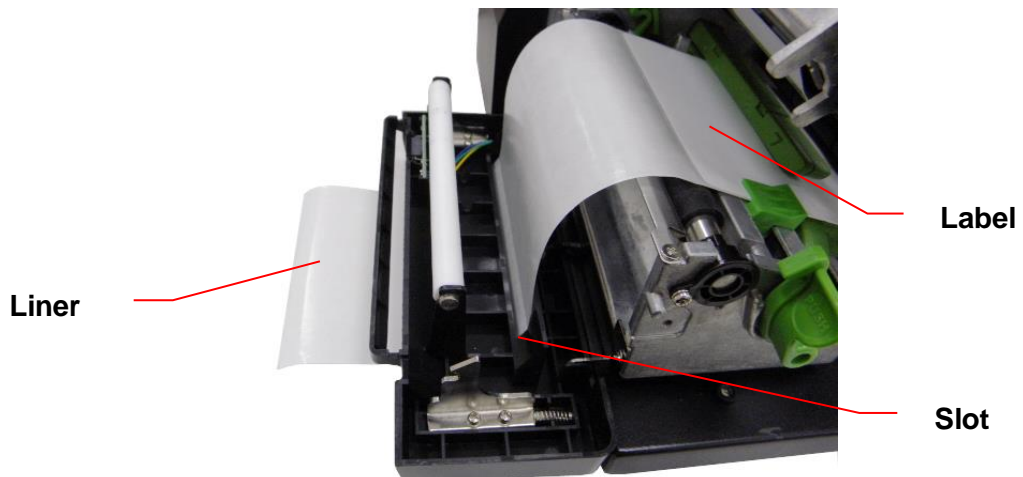

6. Close the peel-off cover and the print head mechanism.

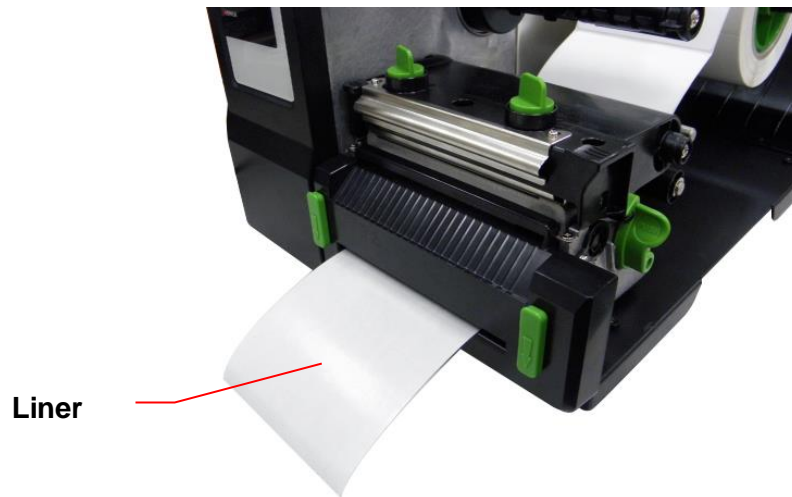

7. Use the DiagTool to set the printer setting for peeler mode. (Please refer the chapter 4)
Peeling will automatically start. Press the FEED button to test.

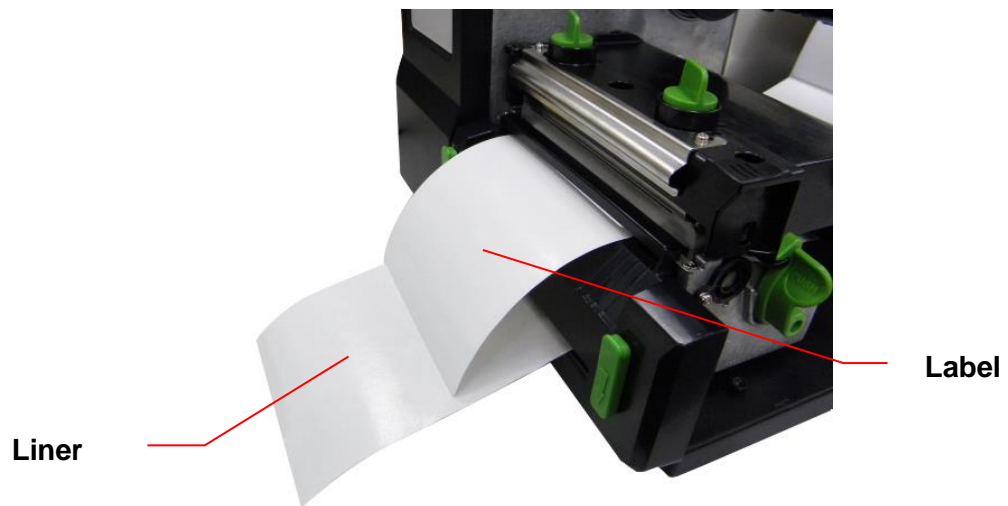

Note:

Please calibrate the gap/black mark sensor when changing media.

2.6.4 Loading the Media in Cutter Mode (Option)

1. Install the label. (Please refer to chapter 2.6.1)
2. Lead the media through the cutter paper opening.
3. Adjust the label guide to fit the width of the label.

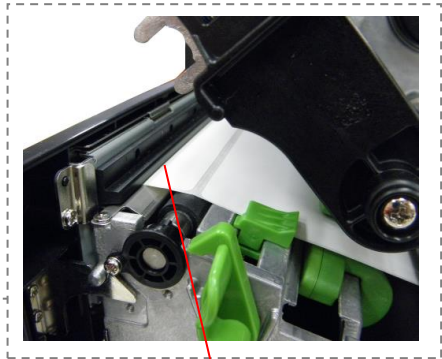
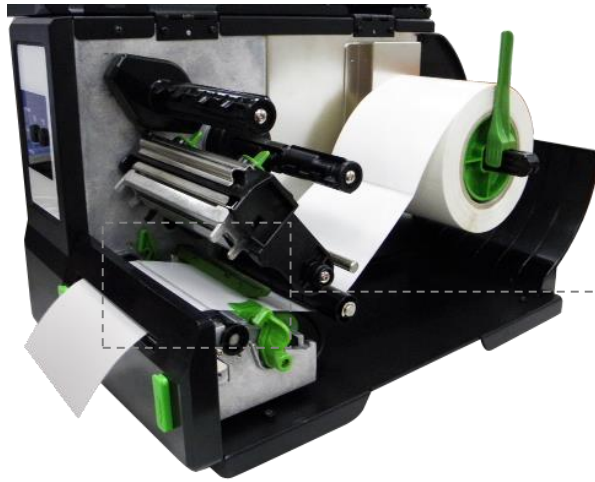

Cutter paper opening

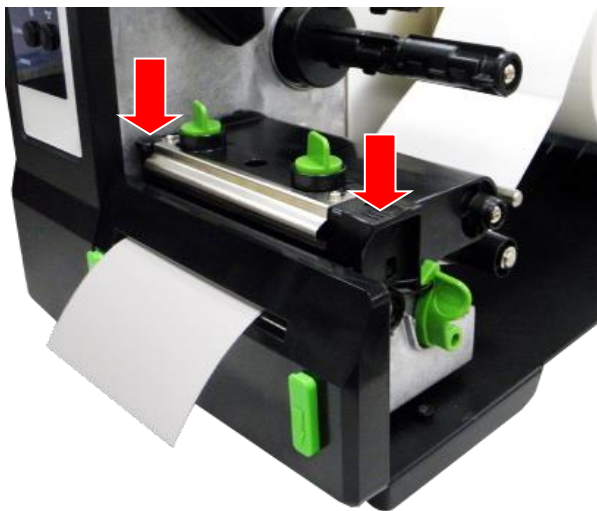

4. Close the print head mechanism making sure the latches are engaged properly.

5. Use the DiagTool to set the printer setting to cutter mode. (Please refer to chapter 4)
Press the FEED button to test.

Note:

Please calibrate the gap/black mark sensor when changing media.

2.7 Print Head Pressure Adjustment Knob

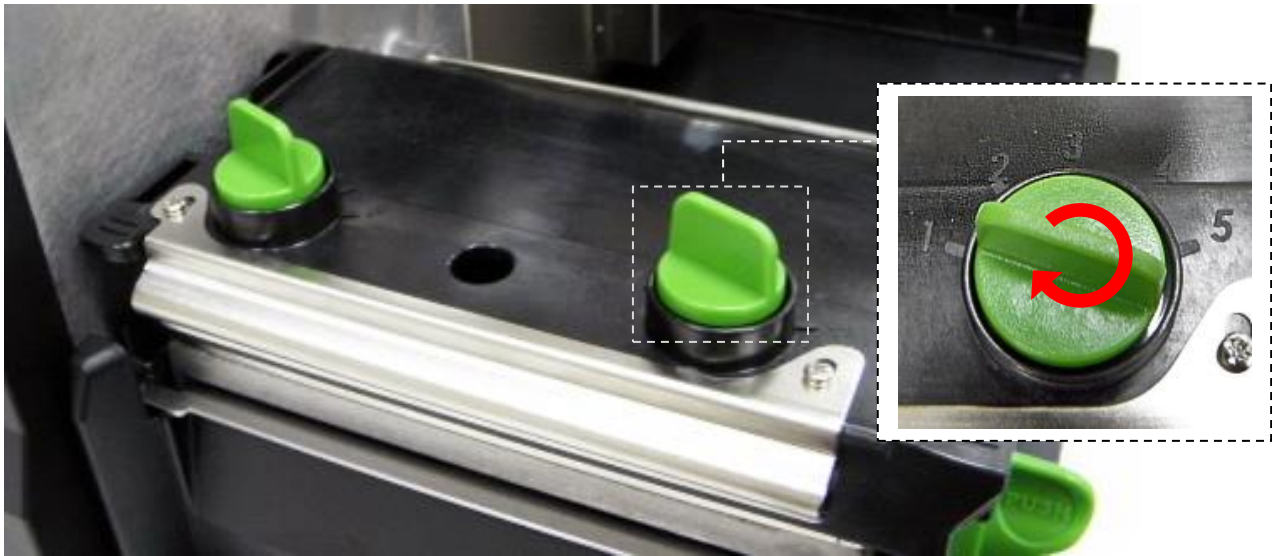

There are two conditions that will need to adjust the print head pressure.

1. Print with thick media
If the media thickness is larger than 0.19 mm, the larger pressure is required to get good quality printout.
2. Print with narrow media
If the media width is less than 4 inch wide the print head pressure will need to be adjusted to avoid ribbon wrinkle.

There are 5 levels of pressure for adjustment. Level 1 is the minimum pressure and level 5 is the maximum pressure.

For example, if the label width is 4 inch, adjust both print head pressure adjustment knobs to the same level. If the label is less than 2 inch wide, increase the left side print head pressure by rotating the adjustment knob clockwise and decrease the right side pressure by rotating the adjustment knob counter-clockwise to level 1.

3. LCD Panel Menu Function (Option)

Main Menu Overview

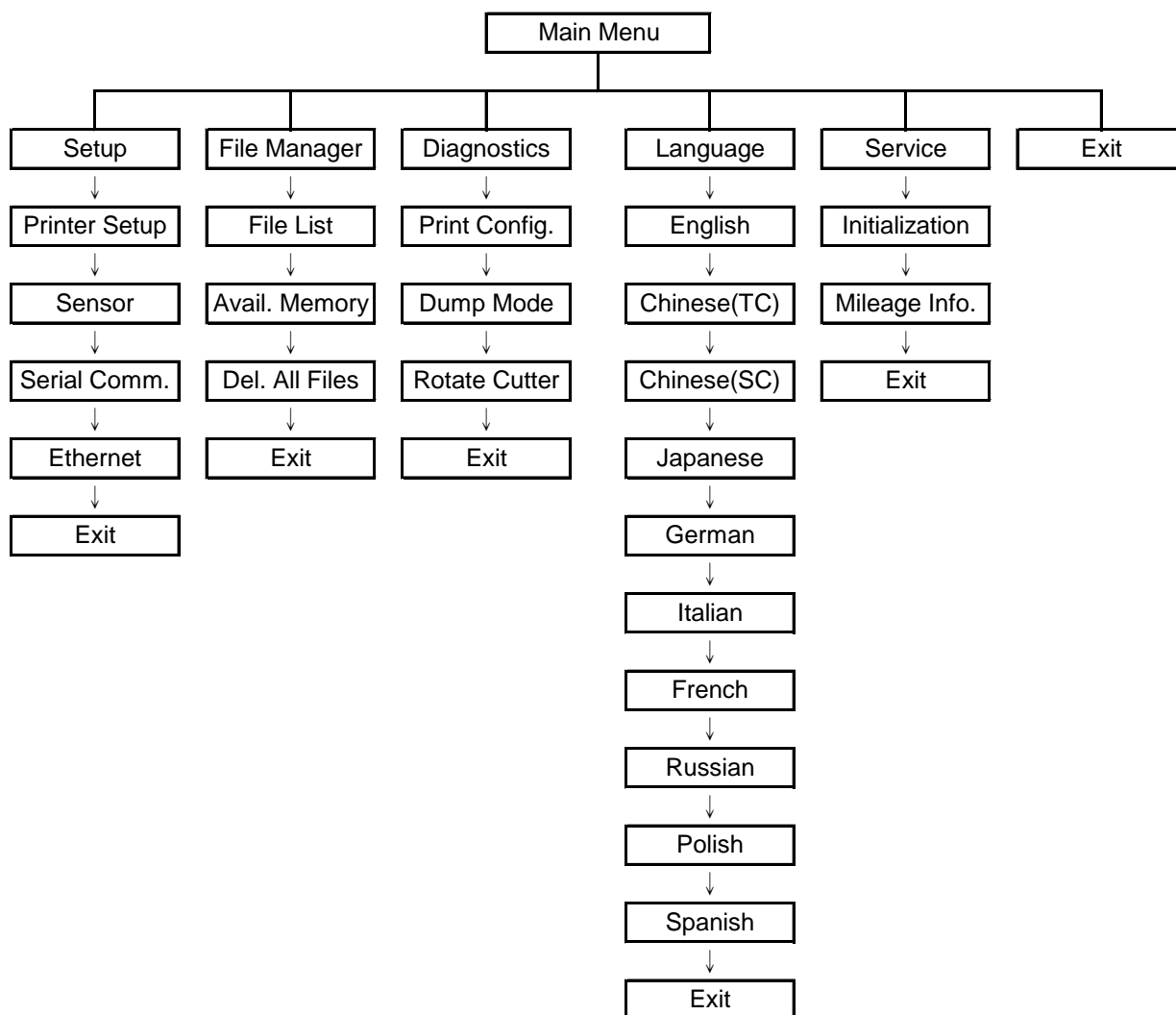

3.1 Setup Menu Overview

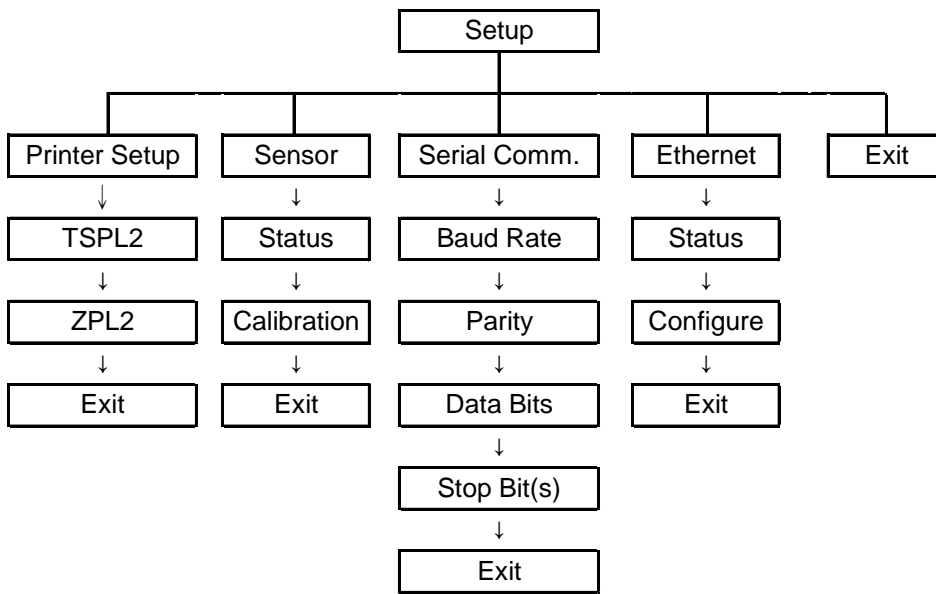

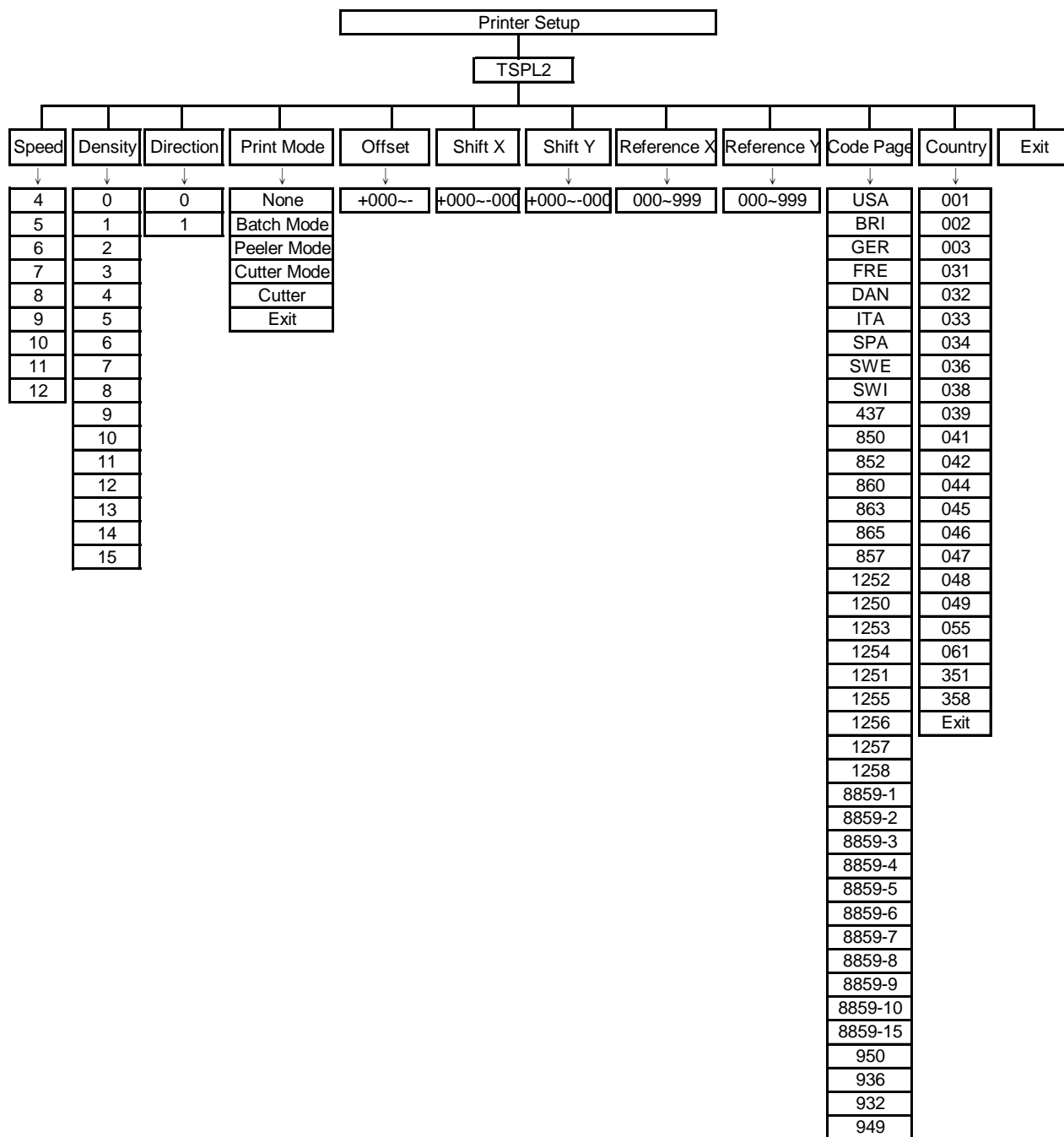

3.1.1-1 Printer Setup (TSPL2)

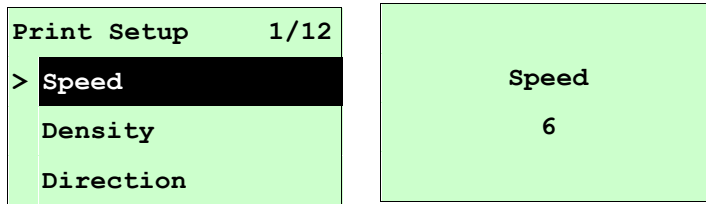

3.1.1-1.1 Speed:



Use this option to setup print speed. Each increment/decrement is 1 ips. Printer default density is 5 ips (203 dpi) or 3 ips(300 dpi).



Press **UP**  key to raise the print speed, and press **DOWN**  key to decrease print speed. Press **SELECT** key to set it into printer. Press  **MENU** key to cancel the setting and return to the previous menu.

Note: If printing from enclosed software/driver, “Use current printer settings” option is not selected, the software/driver will send out the SPEED command, which will overwrite the setting set from the front panel.

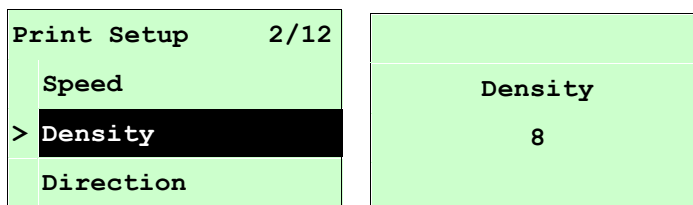
3.1.1-1.2 Density:



Use this option to setup printing darkness. The available setting is from 0 to 15 levels, and the increment is 1 level. Printer default density is 8. You may need to adjust your density based on selected media/ribbon.



Press **UP**  and **DOWN**  to increase/decrease the printing darkness. Press **SELECT** key to enable the setting. Press  **MENU** key to cancel the setting and return to the previous menu.

Note: If printing from enclosed software/driver, the “Use current printer settings” option is not been used, software/driver will send out the DENSITY command, which will overwrite the setting set from the front panel.

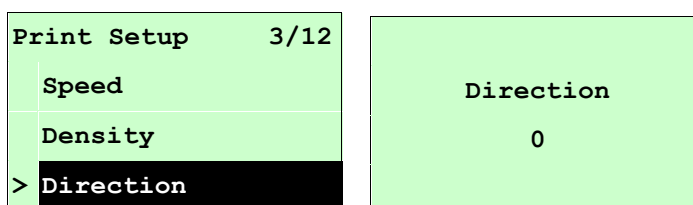
3.1.1-1.3 Direction:



The direction setting value is either 1 or 0. Use this option to setup the printout direction. Printer default printout direction is DIRECTION 0.

Press **UP**  key to set the direction as 1, and **DOWN**  to set it as 0, and **SELECT** key to enable the setting. Press  **MENU** key to cancel the setting and return to the previous menu.

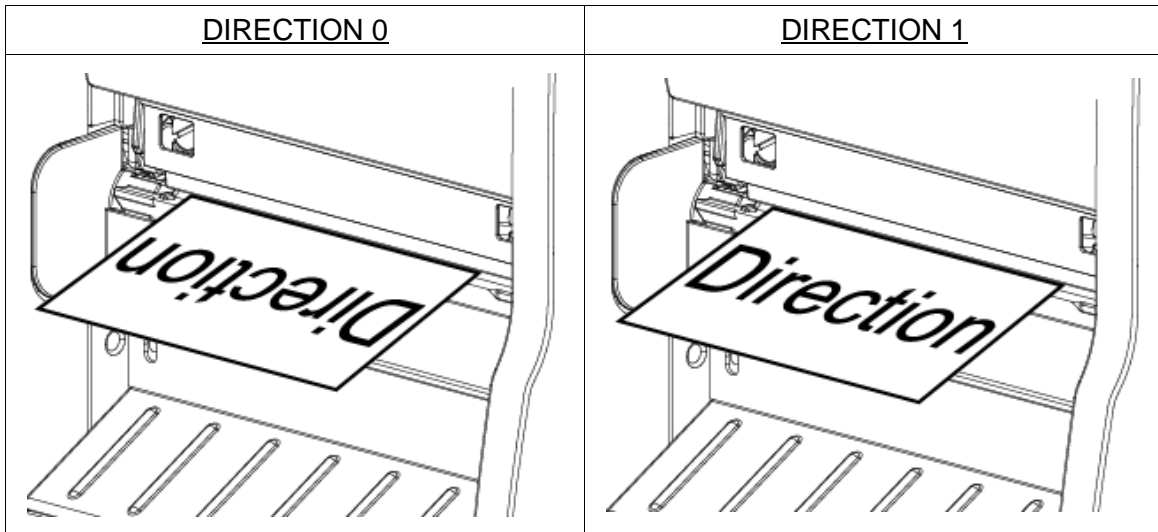

The following 2 figures are the printouts of DIRECTION 0 and 1 for your reference.

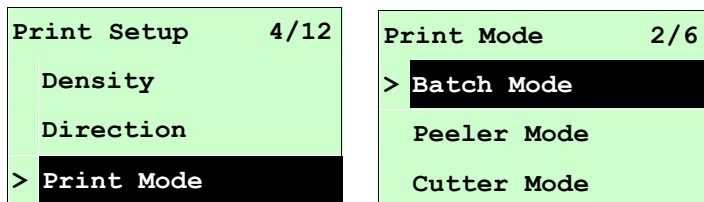

Note: If printing from enclosed software/driver, the software/driver will send out the **DIRECTION 0** command, which will overwrite the setting set from the front panel.

3.1.1-1.4 Print Mode: (None/Batch Mode/Peeler Mode/Cutter Mode/Cutter Batch)



This option is used to set the print mode. Printer default setting is Batch Mode. When enter this list, the print mode in the right side of “>” icon is the printer current setting. Press **UP**  and **DOWN**  to select the different print mode and press **SELECT** button to enable the setting. Press  **MENU** key to cancel the setting and return to the previous menu.

Printer Mode	Description
None	Next label top of form is aligned to the print head burn line location. (Tear Off Mode)
Batch Mode	Once image is printed completely, label gap/black mark will be fed to the tear edge for tear away.
Peeler Mode	Enable the label peel off mode.

Cutter Mode	Enable the cutter mode.
Cutter Batch	Cut the media once at the end of the printing job.

Note: If printing from enclosed software/driver, the software/driver will send out the command, which will overwrite the setting set from the front panel.

3.1.1-1.5 Offset:

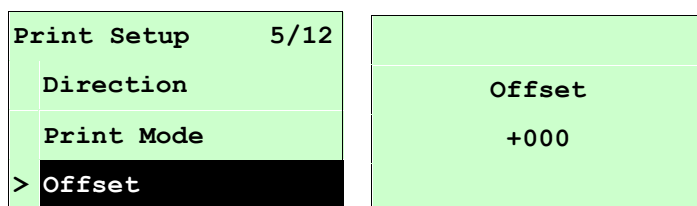

This option is used to fine tune media stop location for peeler and cutter mode. Press the **DOWN** Ⓞ button to move the cursor from left digit to right digit, and press the **UP** Ⓞ button to set the value from “+” to “-” or “0” to “9”. Press the **SELECT** button to set the value into printer. Press **MENU** key to cancel the setting and return to the previous menu. The default value is +000.

Note: If printing from enclosed software/driver, the software/driver will send out the OFFSET command, which will overwrite the setting set from the front panel.

3.1.1-1.6 Shift X & Shift Y:

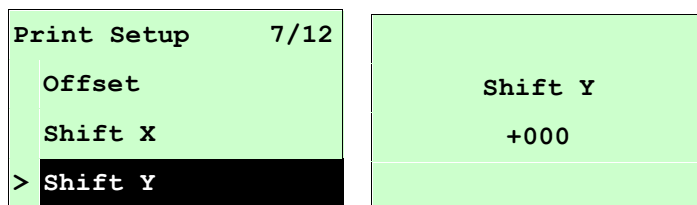

This option is used to fine tune print position. Press the **DOWN** Ⓞ button to move the cursor from left digit to right digit, and press the **UP** Ⓞ button to set the value from “+” to “-” or “0” to “9”. Press the **SELECT** button to set the value into printer. Press **MENU** key to cancel the setting and return to the previous menu. The default value is +000.

Note: If printing from enclosed software/driver, the “Use current printer settings” option is enabled, software/driver will not send out the SHIFT command to overwrite the settings set from the front panel.

3.1.1-1.7 Reference X & Reference Y:

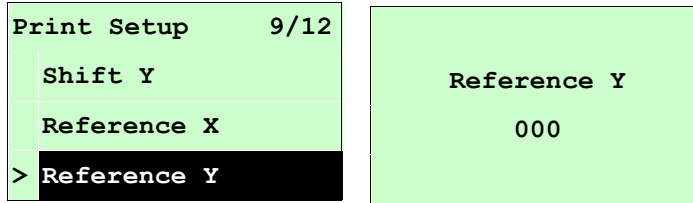

This option is used to set the origin of printer coordinate system horizontally and vertically. Press the **DOWN** Ⓞ button to move the cursor from left digit to right digit, and press the **UP** Ⓞ button to set the value from “0” to “9”. Press the **SELECT** button to set the value into printer. Press **MENU** key to cancel the setting and return to the previous menu. The default value is 000.

Note: If printing from enclosed software/driver, the software/driver will send out the REFERENCE command, which will overwrite the setting set from the front panel.

3.1.1-1.8 Code Page:

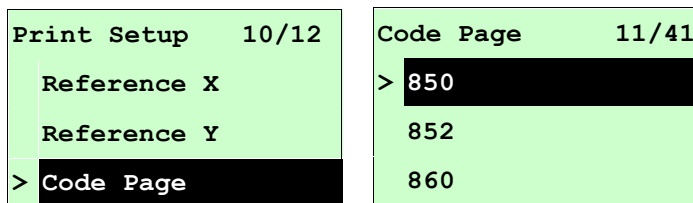

Use this option to set the code page of international character set. For more information about code page, please to refer the programming manual.

When enter the code page list, the code page in the right side of “>” icon is the printer current setting.

Press the **UP** Ⓞ and **DOWN** Ⓞ to select the code page, and press the **SELECT** button to enable the setting. Press **MENU** key to cancel the setting and return to the previous menu.

Note: If printing from enclosed software/driver, the software/driver will send out the command, which will overwrite the setting set from the front panel.

7-bit		8-bit	
code page name	International Character Set	code page number	International Character Set
USA	USA	437	United States
BRI	British	850	Multilingual
GER	German	852	Slavic
FRE	French	860	Portuguese
DAN	Danish	863	Canadian/French
ITA	Italian	865	Nordic
SPA	Spanish		



SWE	Swedish		
SWI	Swiss		

Windows Code Page (SBCS)		Windows Code Page (DBCS)	
code page number	International Character Set	code page number	International Character Set
1252	Latin 1	950	Traditional Chinese Big5
1250	Central Europe	936	Simplified Chinese GBK
1253	Greek	932	Japanese Shift-JIS
1254	Turkish	949	Korean
1251	Cyrillic		
1255	Hebrew		
1256	Arabic		
1257	Baltic		
1258	Vietnam		

ISO Code Page		ISO Code Page	
code page name	International Character Set	code page number	International Character Set
8859-1	Latin 1	8859-7	Greek
8859-2	Latin 2	8859-9	Turkish
8859-3	Latin 3	8859-10	Latin 6
8859-4	Baltic	8859-15	Latin 9
8859-5	Cyrillic		

3.1.1-1.9 Country:

Print Setup 11/12	Country 1/23
Reference Y	> 001
Code Page	002
> Country	003

Use this option to set the country code for the LCD display. Press the **UP**  and **DOWN**  to select the country code, and press the **SELECT** button to set the value into printer. When enter this list, the country code in the right side of “>” icon is the printer current setting. Press  **MENU** key to cancel the setting and return to the previous menu.

Code	Country	Code	Country	Code	Country	Code	Country
001	USA	034	Spanish (Spain)	044	United Kingdom	055	Brazil
002	Canadian-French	036	Hungarian	045	Danish	061	English (International)
003	Spanish (Latin America)	038	Yugoslavian	046	Swedish	351	Portuguese
031	Dutch	039	Italian	047	Norwegian	358	Finnish
032	Belgian	041	Switzerland	048	Polish		
033	French (France)	042	Slovak	049	German		

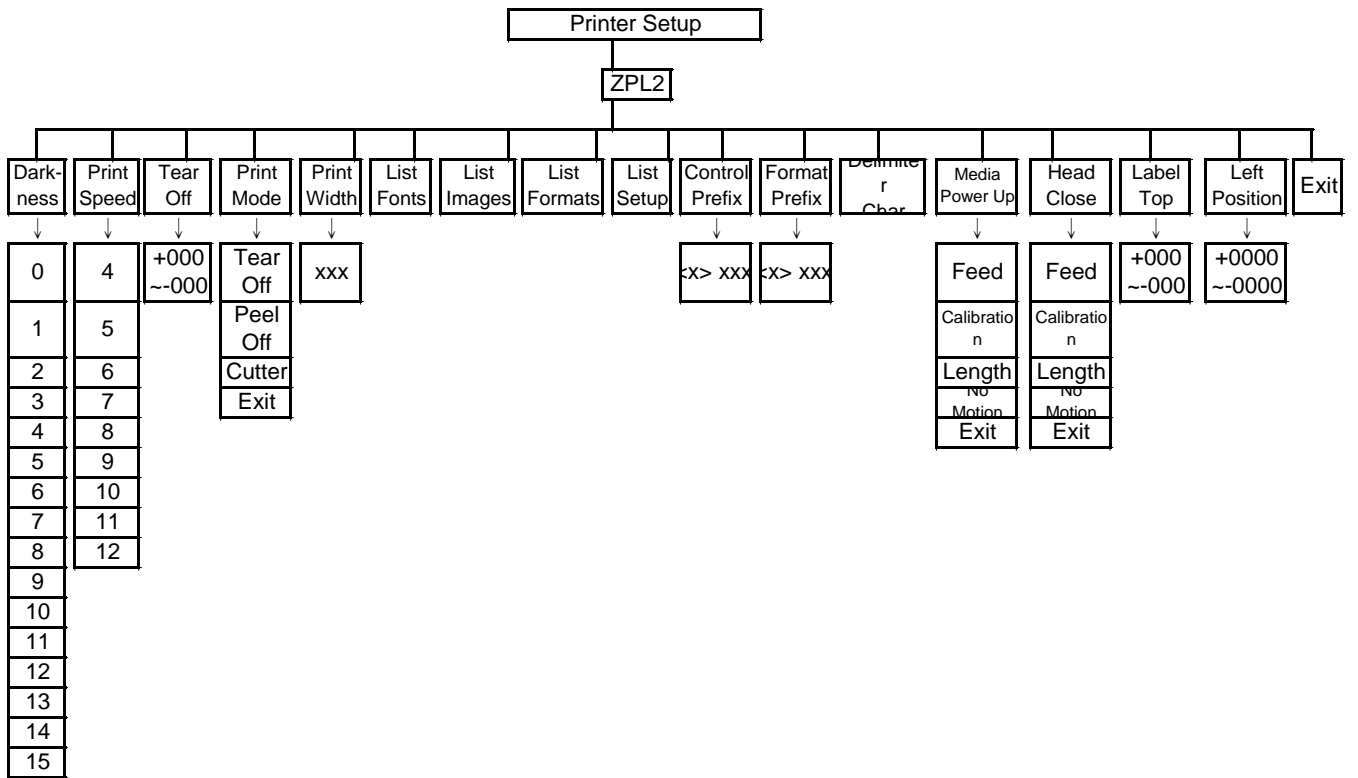

3.1.1-2 Printer Setup (ZPL2)

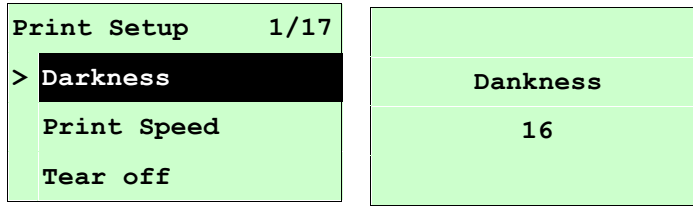

3.1.1-2.1 Darkness:



Use this option to setup printing darkness. The available setting is from 0 to 30, and the step is 1. Printer default density is 16. You may need to adjust your density based on selected media.



Press **UP**  and **DOWN**  to increase/decrease the printing darkness. Press **SELECT** key to enable the setting. Press  **MENU** key to cancel the setting and return to the previous menu.

Note: If printing from enclosed software/driver, the software/driver will send out the command, which will overwrite the setting set from the front panel.

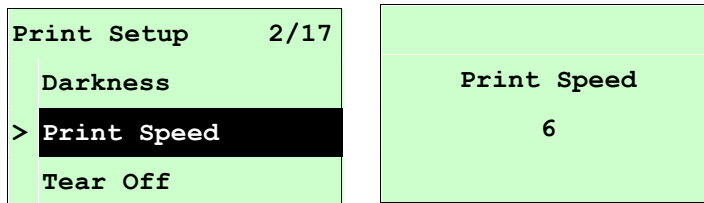
3.1.1-2.2 Print Speed:





Use this option to setup print speed. The each increment/decrement is 1 ips.

Press **UP**  key to raise the print speed, and press **DOWN**  key to decrease print speed. Press **SELECT** key to set it into printer. Press  **MENU** key to cancel the setting and return to the previous menu.

Note: If printing from enclosed software/driver, the software/driver will send out the command, which will overwrite the setting set from the front panel.

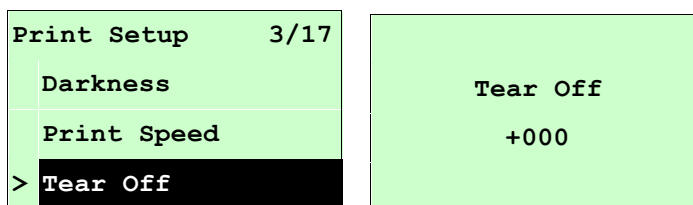
3.1.1-2.3 Tear Off:



This option is used to fine tune media stop location. Press the **DOWN**  button to move the cursor from left digit to right digit, and press the **UP**  button to set the value from "+" to

“-” or “0” to “9”. Press the **SELECT** button to set the value into printer. Press **MENU** key to cancel the setting and return to the previous menu. The default value is +000.

Note: If printing from enclosed software/driver, the software/driver will send out the command, which will overwrite the setting set from the front panel.

3.1.1-2.4 Print Mode: (Tear Off / Peel Off / Cutter)

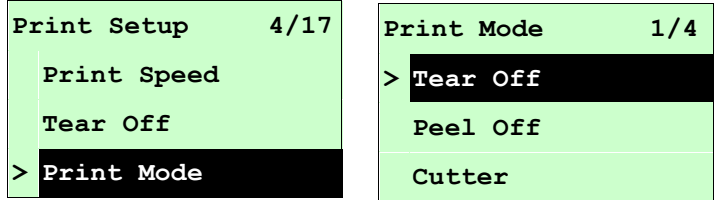

This option is used to set the print mode. Printer default setting is Tear Off. When enter this list, the print mode in the right side of “>” icon is the printer current setting. Press **UP** and **DOWN** to select the different print mode and press **SELECT** button to enable the setting. Press **MENU** key to cancel the setting and return to the previous menu.

Printer Mode	Description
Tear Off	Next label top of form is aligned to the print head burn line location.
Peel Off	Enable the label peel off mode.
Cutter	Enable the label cutter mode.

Note: If printing from enclosed software/driver, the software/driver will send out the command, which will overwrite the setting set from the front panel.

3.1.1-2.5 Print Width:

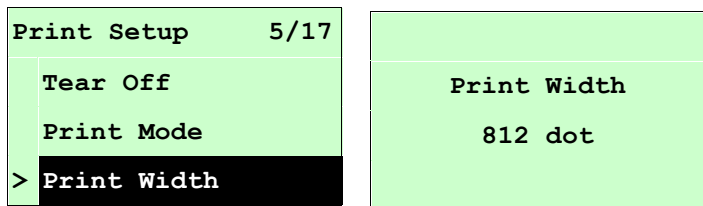

This option is used to set print width. Press the **DOWN** button to move the cursor from left digit to right digit, and press the **UP** button to set the value from “0” to “9” or “dot” to “mm”. Press the **SELECT** button to set the value into printer. Press **MENU** key to cancel the setting and return to the previous menu.

Note: If printing from enclosed software/driver, the software/driver will send out the command, which will overwrite the setting set from the front panel.

3.1.1-2.6 List Fonts:

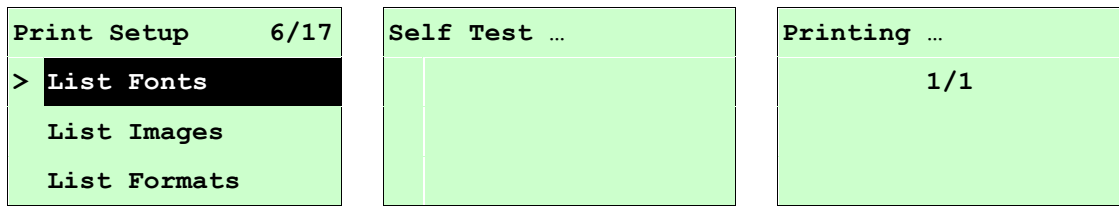

This feature is used to print current printer available fonts list to the label. The fonts stored in the printer's DRAM, Flash or optional memory card. Press **SELECT** button to print the list.

3.1.1-2.7 List Images:

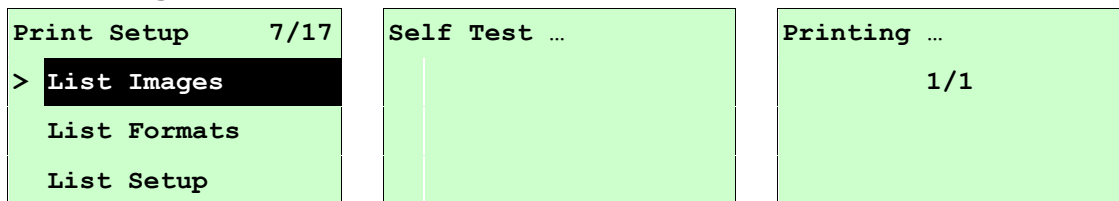

This feature is used to print current printer available images list to the label. The images stored in the printer's DRAM, Flash or optional memory card. Press **SELECT** button to print the list.

3.1.1-2.8 List Formats:

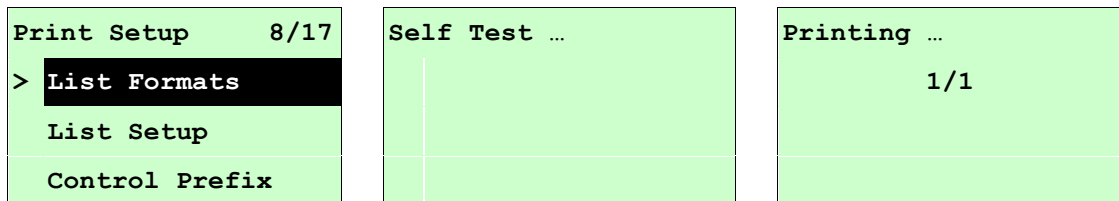

This feature is used to print current printer available formats list to the label. The formats stored in the printer's DRAM, Flash or optional memory card. Press **SELECT** button to print the list.

3.1.1-2.9 List Setup:

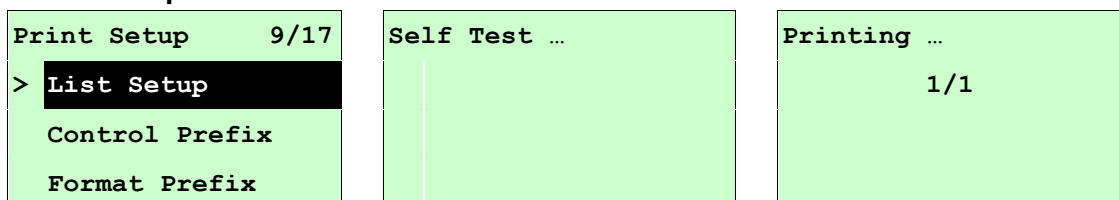

This feature is used to print current printer configuration to the label. Press **SELECT** button to print the list.

3.1.1-2.10 Control Prefix:

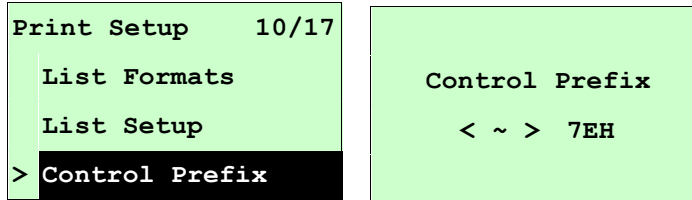

This option is used to set control prefix character. Press the **DOWN** ⏴ button to move the cursor from left digit to right digit, and press the **UP** ⏵ button to set the value from “0” to “9” or “A” to “F”. Press the **SELECT** button to set the value into printer. Press **MENU** key to cancel the setting and return to the previous menu.

3.1.1-2.11 Format Prefix:

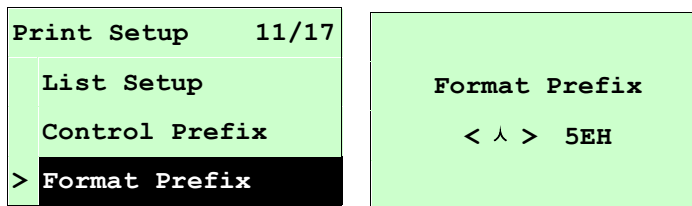

This option is used to set format prefix character. Press the **DOWN** ⏴ button to move the cursor from left digit to right digit, and press the **UP** ⏵ button to set the value from “0” to “9” or “A” to “F”. Press the **SELECT** button to set the value into printer. Press **MENU** key to cancel the setting and return to the previous menu.

3.1.1-2.12 Delimiter Char:

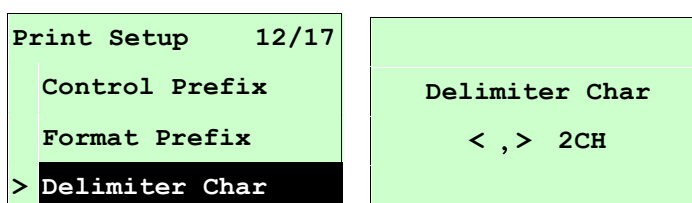

This option is used to set delimiter character. Press the **DOWN** Ⓞ button to move the cursor from left digit to right digit, and press the **UP** Ⓞ button to set the value from “0” to “9” or “A” to “F”. Press the **SELECT** button to set the value into printer. Press **≡ MENU** key to cancel the setting and return to the previous menu.

3.1.1-2.13 Media Power Up:

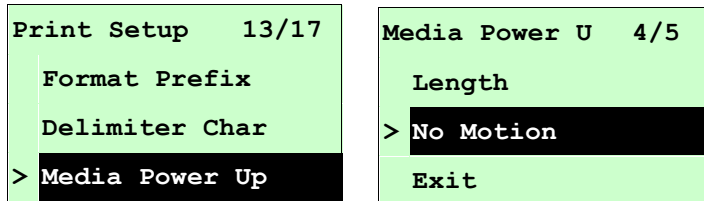

This option is used to set the action of the media when you turn on the printer. Printer default setting is No Motion. When enter this list, the print mode in the right side of “>” icon is the printer current setting. Press **UP** Ⓞ and **DOWN** Ⓞ to select the different print mode and press **SELECT** button to enable the setting. Press **≡ MENU** key to cancel the setting and return to the previous menu.

Selections	Description
Feed	Printer will advance one label
Calibration	Printer will calibration the sensor levels, determine length and feed label
Length	Printer determine length and feed label
No Motion	Printer will not move media

3.1.1-2.14 Head Close:

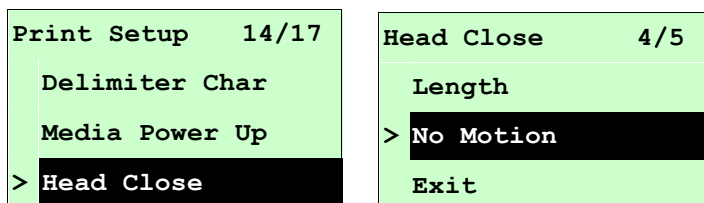

This option is used to set the action of the media when you close the printhead. Printer default setting is No Motion. When enter this list, the print mode in the right side of “>” icon is the printer current setting. Press **UP** Ⓞ and **DOWN** Ⓞ to select the different print mode and press **SELECT** button to enable the setting. Press **≡ MENU** key to cancel the setting and return to the previous menu.

Selections	Description
Feed	Printer will advance one label
Calibration	Printer will calibration the sensor levels, determine length and feed label
Length	Printer determine length and feed label
No Motion	Printer will not move media

3.1.1-2.15 Label Top:

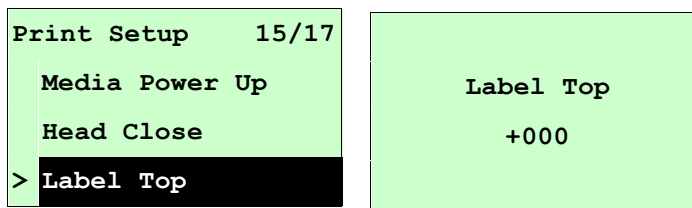

This option is used to adjust print position vertically on the label. Press the **DOWN** Ⓞ button to move the cursor from left digit to right digit, and press the **UP** Ⓞ button to set the value from “+” to “-” or “0” to “1/2”. Press the **SELECT** button to set the value into printer. Press **MENU** key to cancel the setting and return to the previous menu. The default value is +000 and range is -120 to +120 dots.

3.1.1-2.16 Left Position:

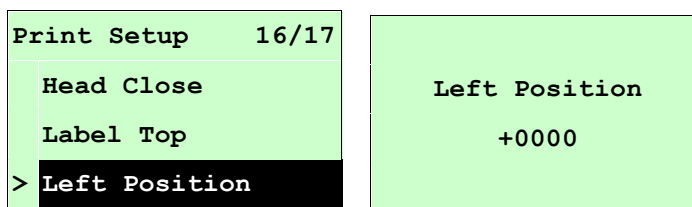

This option is used to adjust print position horizontally on the label. Press the **DOWN** Ⓞ button to move the cursor from left digit to right digit, and press the **UP** Ⓞ button to set the value from “+” to “-” or “0” to “9”. Press the **SELECT** button to set the value into printer. Press **MENU** key to cancel the setting and return to the previous menu. The default value is +0000 and range is -9999 to +9999 dots.

3.1.2 Sensor

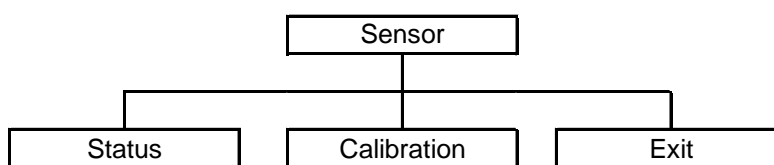

3.1.2.1 Status

This function is available to check the printer's sensor status. When enter the [Status] option, you will see following message.

Paper Len.	812
Gap Size	24
Intensity	3
Ref. Level	512

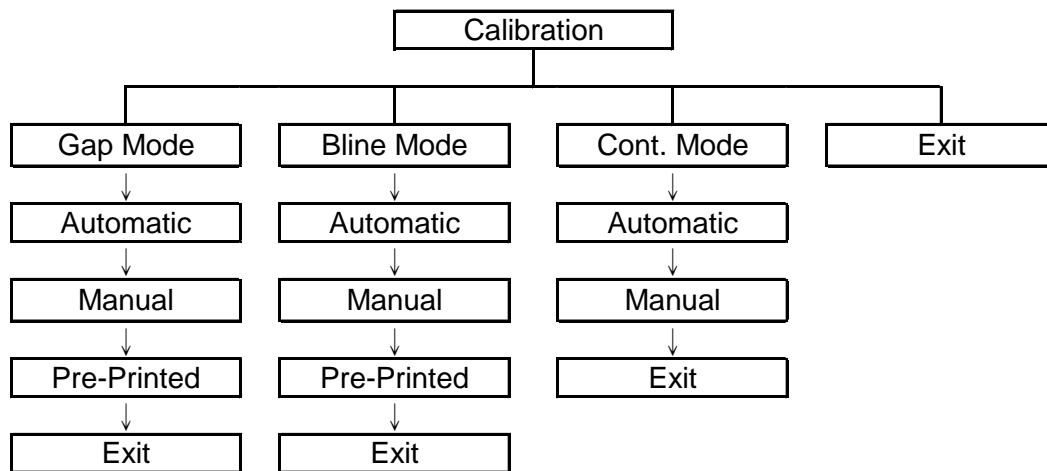

3.1.2.2 Calibration

This option is used to set the media sensor type and calibrate the selected sensor. We recommend to calibrate the sensor before printing when changing the media.

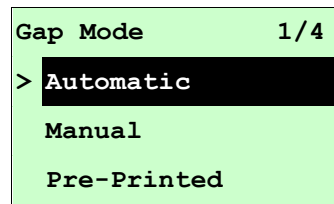
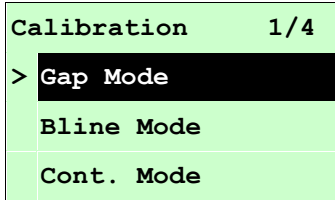

A. Gap Mode



Press the **UP**  and **DOWN**  buttons to scroll the cursor to the media type and press the **SELECT** button to enter the sensor calibration mode.

Note: *If printing from enclosed software/driver, the software/driver will send out the GAP or BLINE command, which will overwrite the sensor type setting set from the front panel.*

A-1 Automatic

When enter the [Automatic] option, you will see following message, and printer will feed 2 to 3 gap labels to calibrate the sensor sensitivity automatically. When calibration is completed, the LCD screen will return to the previous menu.

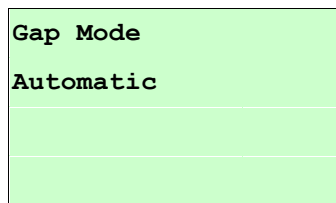

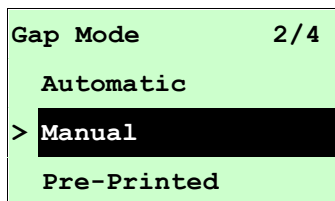

A-2 Manual

In case “Automatic” sensor calibration cannot apply to the media, please use “Manual” function to calibrate the gap sensor manually.



When enter [Manual] option, you will see following message. Please complete those steps :

<p>Paper Len. 00812 dot</p>	<ol style="list-style-type: none">1. Press the DOWN  button to move the cursor from left digit to right digit, and press the UP  button to set the value from “0” to “9” and the “dot/mm/ inch”. Press the SELECT button to set the paper length into the printer.
---------------------------------	---

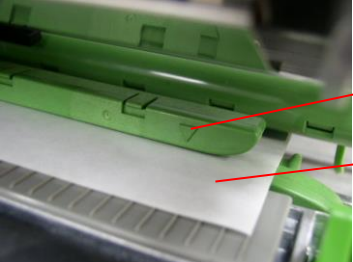
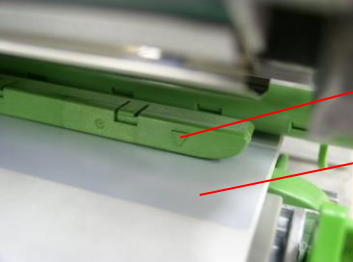
<p style="text-align: center;">Gap Size</p> <p style="text-align: center;">0024 dot</p>	<p>2. Press the DOWN ⏴ button to move the cursor from left digit to right digit, and press the UP ⏵ button to set the value from “0” to “9” and the “dot/mm/ inch”. Press the SELECT button to set the gap size into the printer.</p>
<p>Gap Mode</p> <p>Scan Backing</p> <p>Intensity x</p> <p>Ref. Level xxx</p>	<p>3. Open the print head mechanism, put the label backing (liner) under the media sensor. Press the SELECT button to set the value into the printer.</p>
	<p>Media sensor location</p> <p>Label backing (liner)</p>
<p>Gap Mode</p> <p>Scan Paper</p> <p>Intensity x</p> <p>Ref. Level xxx</p>	<p>4. Then, Put the label with liner under the media sensor. Press the SELECT button to set the value into the printer.</p>
	<p>Media sensor location</p> <p>Label with liner</p>
<p>Gap Mode</p> <p>Complete</p> <p>Intensity x</p> <p>Ref. Level xxx</p>	<p>5. The gap sensor calibration is complete. Press the SELECT button the LCD screen will return to the previous menu.</p>

A-3 Pre-Printed

This function will need to set the paper length and gap size before auto-calibrate the sensor sensitivity. It can get the sensor sensitivity more accurately for pre-printed media.

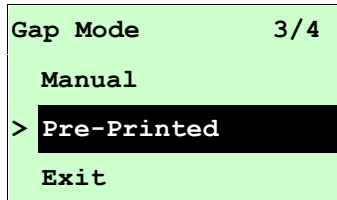

When enter [Pre-Printed] option, you will see following message. Please complete there steps :

<p>Paper Len. 00812 dot</p>	<p>1. Press the DOWN Ⓢ button to move the cursor from left digit to right digit, and press the UP Ⓢ button to set the value from “0” to “9” and the “dot/mm/ inch”. Press the SELECT button to set the paper length into the printer.</p>
<p>Gap Siz□ 0024 dot</p>	<p>2. Press the DOWN Ⓢ button to move the cursor from left digit to right digit, and press the UP Ⓢ button to set the value from “0” to “9” and the “dot/mm/ inch”. Press the SELECT button to set the gap size into the printer.</p>
<p>Gap Mode Pre-Printed</p>	<p>3. Then, printer will feed labels to calibrate the sensor sensitivity automatically. When calibration is completed, the LCD screen will return to the previous menu.</p>

B. Bline Mode

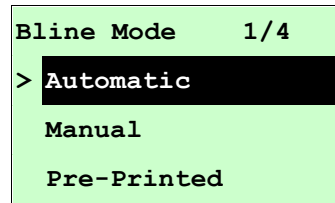
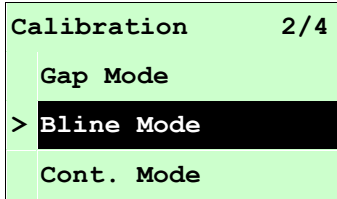

Press the **UP** ⬆ and **DOWN** ⬇ buttons to scroll the cursor to the sensor type. Press the **SELECT** button to enter the black-mark sensor calibration mode.

B-1 Automatic

When enter the [Automatic] option, you will see following message and printer will feed the black mark label to calibrate the sensor sensitivity automatically. When calibration process is completed, the LCD screen will return to the previous menu.

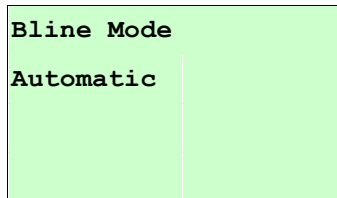

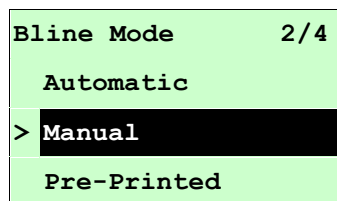

B-2 Manual

In case “Automatic” sensor calibration cannot apply to the media, please use “Manual” function to calibrate the bline sensor manually.

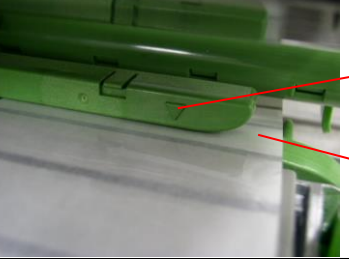

When enter [Manual] option, you will see following message. Please complete there steps :

<pre> Paper Len. 00151 dot </pre>	<ol style="list-style-type: none"> 1. Press the DOWN ⬇ button to move the cursor from left digit to right digit, and press the UP ⬆ button to set the value from “0” to “9” and the “dot/ mm/ inch”. Press the SELECT button to set the paper length into the printer.
<pre> Bline Size 0024 dot </pre>	<ol style="list-style-type: none"> 2. Press the DOWN ⬇ button to move the cursor from left digit to right digit, and press the UP ⬆ button to set the value from “0” to “9” and the “dot/ mm/ inch”. Press the SELECT button to set the bline size into the printer.

<pre> Bline Mode Scan Mark Intensity x Ref. Level xxx </pre>	<p>3. Open the print head mechanism, put the black mark under the media sensor. Press the SELECT button to set the value into the printer.</p>
	<p>Media sensor Black mark</p>
<pre> Bline Mode Scan Paper Intensity x Ref. Level xxx </pre>	<p>4. Then, put the label without black mark under the media sensor. Press the SELECT button to set the value into the printer.</p>
	<p>Media sensor Label without black mark</p>
<p>Note: Normally, the value of "Ref. Level" for mark should be larger than paper for over 128. If the media sensor fails to do so, you have to manually change the Intensity by pressing UP  and DOWN  to reach the above value.</p>	
<pre> Bline Mode Complete Intensity x Ref. Level xxx </pre>	<p>5. The bline sensor calibration is complete. Press the SELECT button the LCD screen will return to the previous menu.</p>

B-3 Pre-Printed

This function will need to set the paper length and gap size before auto-calibrate the sensor sensitivity. It can get the sensor sensitivity more accurately for pre-printed media.

<pre> Bline Mode 3/4 </pre>
<pre> Manual </pre>
<pre> > Pre-Printed </pre>
<pre> Exit </pre>

When enter [Pre-Printed] option, you will see following message. Please complete there steps :

<p style="text-align: center;">Paper Len.</p> <p style="text-align: center;">00812 dot</p>	<p>1. Press the DOWN ⤵ button to move the cursor from left digit to right digit, and press the UP ⤴ button to set the value from “0” to “9” and the “dot/mm/ inch”. Press the SELECT button to set the paper length into the printer.</p>
<p style="text-align: center;">Bline Size</p> <p style="text-align: center;">0024 dot</p>	<p>2. Press the DOWN ⤵ button to move the cursor from left digit to right digit, and press the UP ⤴ button to set the value from “0” to “9” and the “dot/mm/ inch”. Press the SELECT button to set the bline size into the printer.</p>
<p>Bline Mode</p> <p>Pre-Printed</p>	<p>3. Then, printer will feed labels to calibrate the sensor sensitivity automatically. When calibration is completed, the LCD screen will return to the previous menu.</p>

C. Cont. Mode

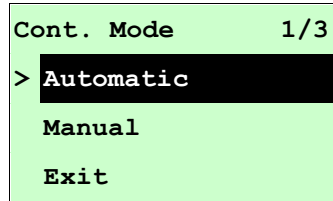
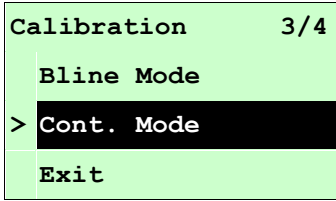

Press the **UP** ⬆ and **DOWN** ⬇ buttons to scroll the cursor to the sensor type. Press the **SELECT** button to enter the black-mark sensor calibration mode.

C-1 Automatic

When enter the [Automatic] option, you will see following message and printer will calibrate the sensor sensitivity automatically. When calibration process is completed, the LCD screen will return to the previous menu.

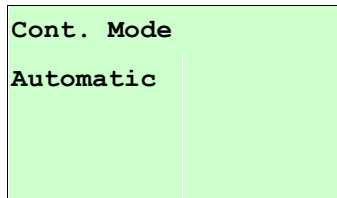

C-2 Manual

In case “Automatic” sensor calibration cannot apply to the media, please use “Manual” function to calibrate the sensor manually.

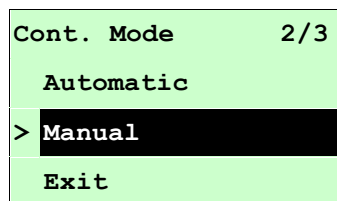

When enter [Manual] option, you will see following message. Please complete there steps :

<pre> Cont. Mode Remove Label Intensity x Ref. Level xxx </pre>	<p>1. Remove the continuous label. Press the SELECT button to set the value into the printer.</p>
<pre> Cont. Mode Scan Paper Intensity x Ref. Level xxx </pre>	<p>2. Then, put the continuous label under the media sensor. Press the SELECT button to set the value into the printer.</p>

Cont. Mode	
Complete	
Intensity	x
Ref. Level	xxx

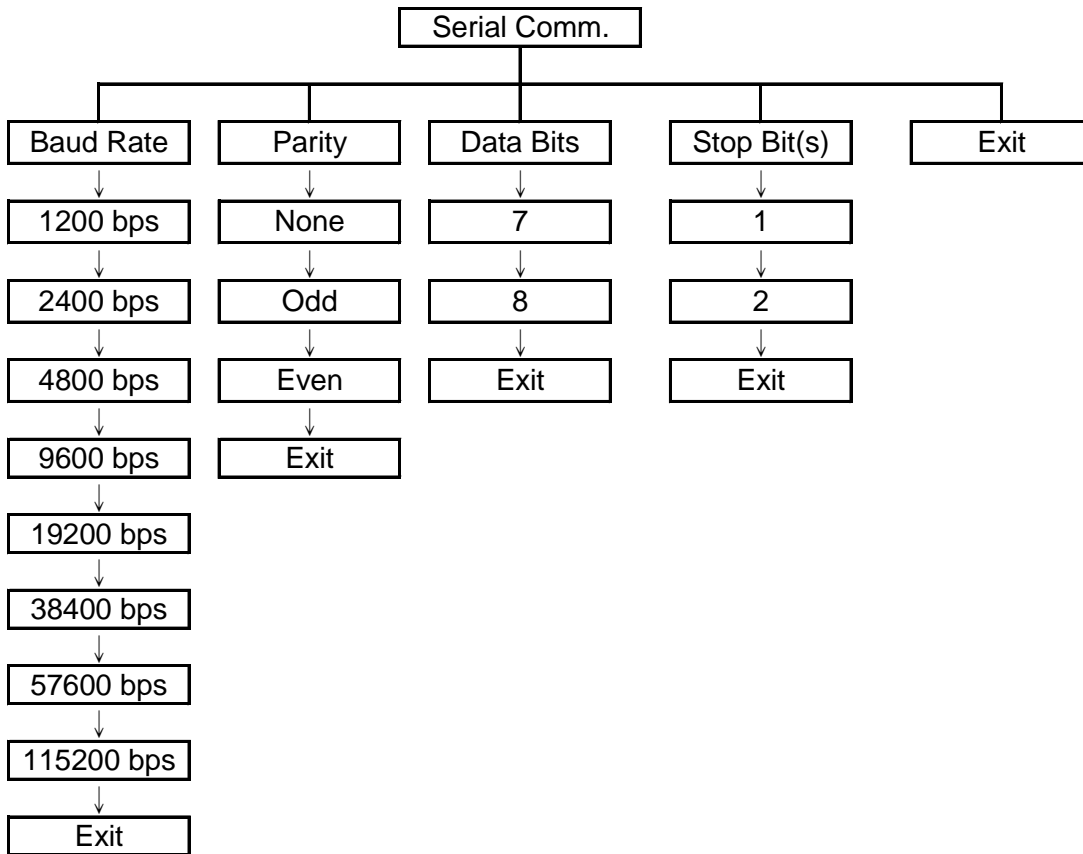

3. The sensor calibration is complete.
Press the **SELECT** button the LCD screen will return to the previous menu.

3.1.3 Serial Comm.



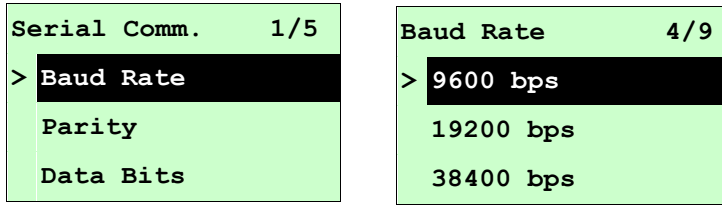



3.1.3.1 Baud Rate

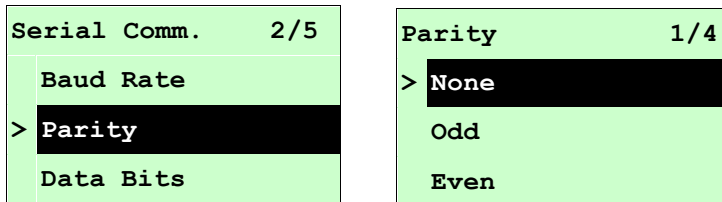

This option is used to set the RS-232 baud rate. The default setting is 9600 bps. Press **UP**  and **DOWN**  buttons to select the different baud rate and press **SELECT** button to set the value into printer. When you enter this list, the baud rate value in the right side of ">" icon is the current setting in the printer. Press  **MENU** key to cancel the setting and return to the previous menu.



3.1.3.2 Parity

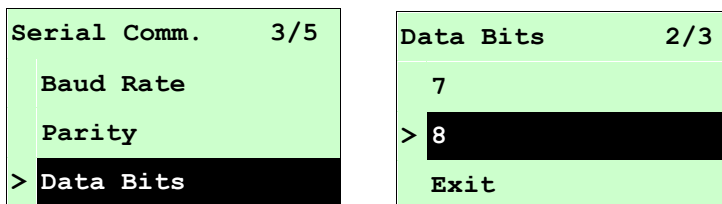

This option is used to set the RS-232 parity. The default setting is "None". Press **UP**  and **DOWN**  buttons to select the different parity and press **SELECT** button to set the value into printer. When you enter this list, the parity in the right side of ">" is the printer current setting. Press  **MENU** key to cancel the setting and return to the previous menu.

3.1.3.3 Data Bits:



This option is used to set the RS-232 Data Bits. The default setting is "8" data bits. Press **UP**  and **DOWN**  buttons to select the different Data Bits and press **SELECT** button to set the value into printer. When you enter this list, the Data Bits in the right side of ">" icon is the printer current setting. Press  **MENU** key to cancel the setting and return to the previous menu.

3.1.3.4 Stop Bit(s):

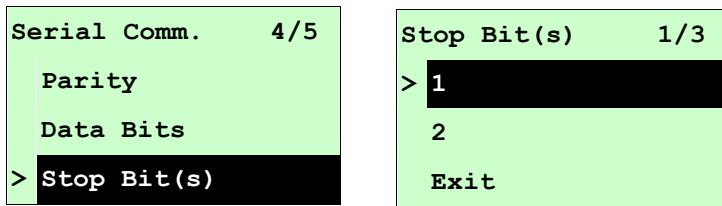

This option is used to set the RS-232 Stop Bits. The default setting is “1” stop bit. Press **UP** and **DOWN** buttons to select the different Stop Bits and press **SELECT** button to set the value into printer. When you enter this list, the option in the right side of “>” icon is the printer current setting. Press **MENU** key to cancel the setting and return to the previous menu.

3.1.4 Ethernet

Use this menu to configure internal Ethernet configuration check the printer’s Ethernet module status, and reset the Ethernet module. This function is available on the LCD display when Ethernet card is installed.

Press **UP** and **DOWN** buttons to select the different options and press **SELECT** button to enter the option. Press **MENU** key to cancel the setting and return to the previous menu.

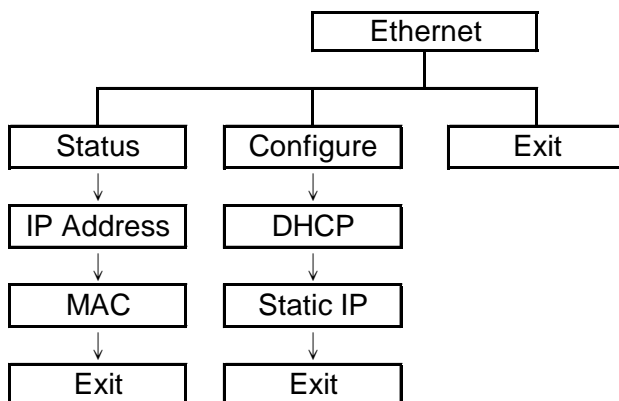

3.1.4.1 Status: (IP Address / MAC)

Use this menu to check the Ethernet setting status.

3.1.4.1.1 IP Address

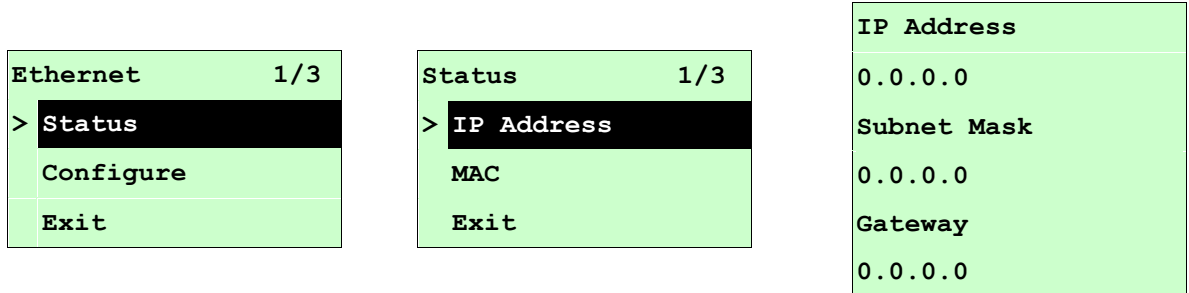

The IP address information will be shown on the LCD display. Please press **SELECT** or **MENU** button to return to the previous menu.

3.1.4.1.2 MAC

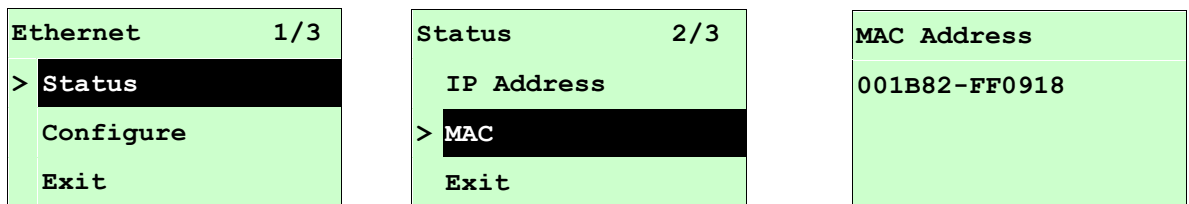

The MAC address information will be shown on the LCD display. Please press **SELECT** or **MENU** button to return to the previous menu.

3.1.4.2 Configure: (DHCP / Static IP)

Use this menu to set the printer's DHCP and Static IP.

3.1.4.2.1 DHCP

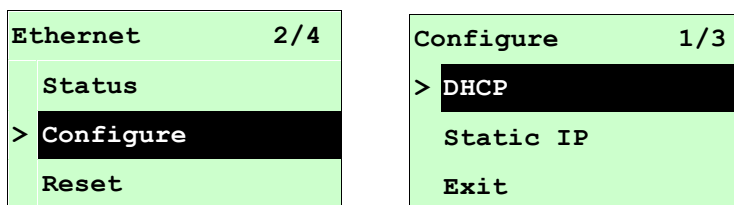

Press **UP** and **DOWN** buttons to select the DHCP function and press **SELECT** to enter. Press **MENU** key to cancel the setting and return to the previous menu.

DHCP	
SELECT :	YES
MENU :	NO

Press **SELECT** button the printer will set DHCP and restart to reset the setting.

Press  **MENU** button to return to the previous menu.

3.1.4.2.2 Static IP

Use this menu to set the printer's IP address, subnet mask and gateway.

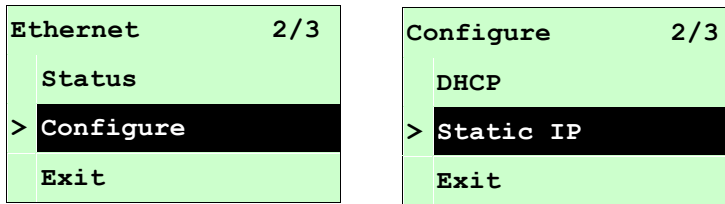

Press **UP** and **DOWN** buttons to select the different options and press **SELECT** button to enter the option. Press **MENU** key to cancel the setting and return to the previous menu.

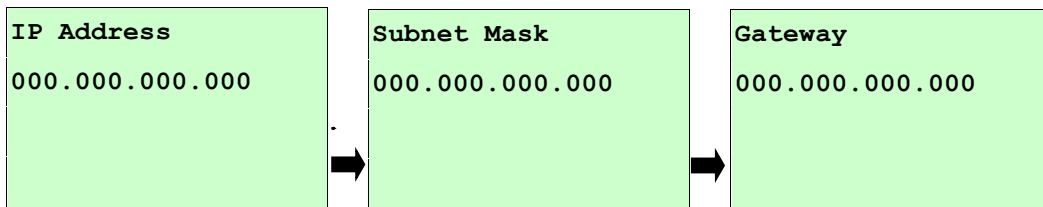

Press **DOWN** button to move the cursor from left to right digits and press the **UP** button to scroll the value from "0" to "9". Press **SELECT** button to next setting.

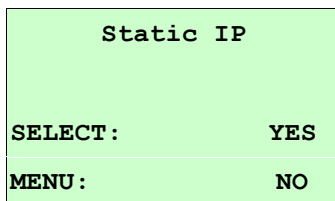

Press the **SELECT** button printer will restart to reset the Ethernet module setting. Press **MENU** key to cancel the setting.

3.2 File Manager

This feature is used to check the printer available memory and file list.

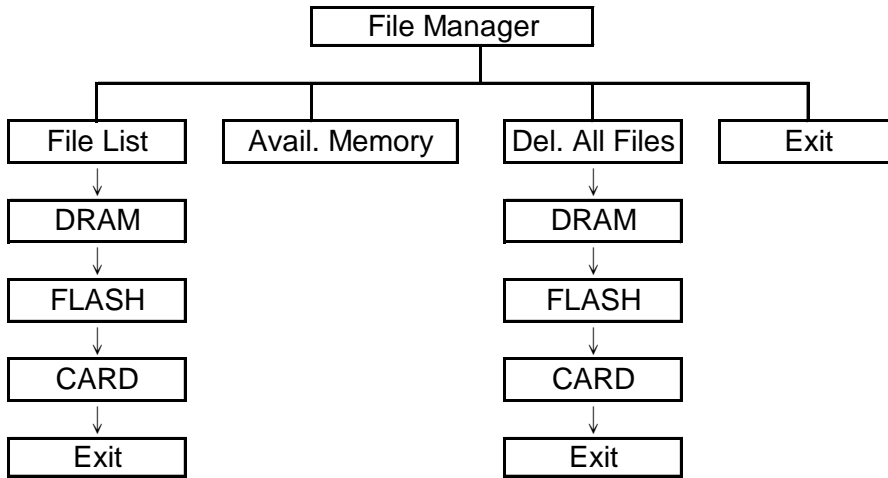

3.2.1 File List

Use this menu to show, delete and run (.BAS) the files saved in the printer DRAM/Flash/Card memory.

To show the files :

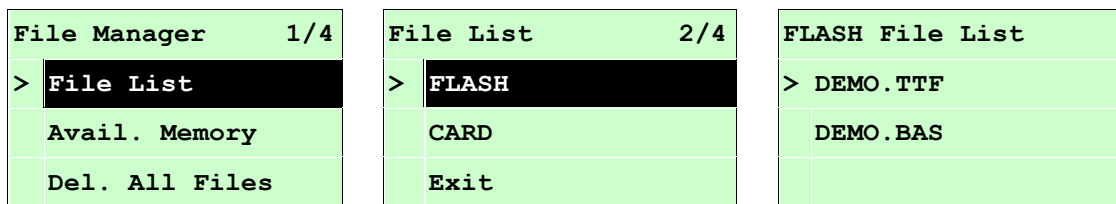

To delete the file : Please follow the order to press the **DOWN** Ⓞ button.

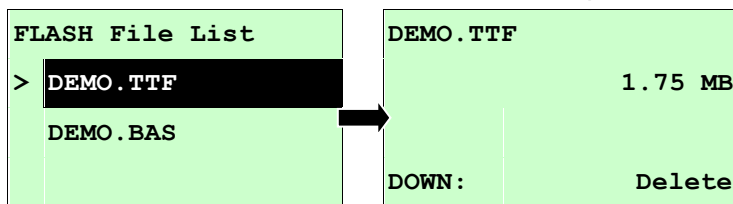

To run the file (.BAS) : Please follow the order to press the **SELECT** button.

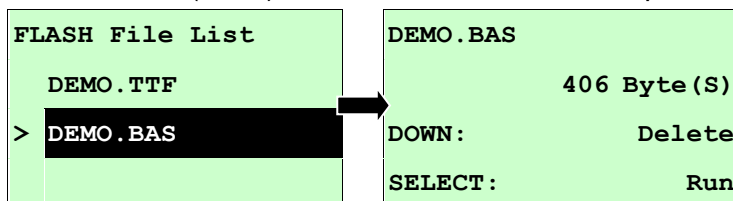

3.2.2 Avail. Memory

Use this menu to show available memory space.

File Manager 2/4	Avail. Memory
File List	DRAM: 256 KB
> Avail. Memory	FALSH: 6656 KB
Del. All Files	CARD: 0 KB

3.2.3 Del. All Files

Use this menu to delete all files. Press **SELECT** button to delete all files in the device. Press **MENU** to cancel deleting files and go back to previous menu.

File Manager 3/4	File List 1/4	Del. All Files
File List	> DRAM	
Avail. Memory	FALSH	SELECT: YES
> Del. All File	CARD	MENU: NO

3.3 Diagnostics

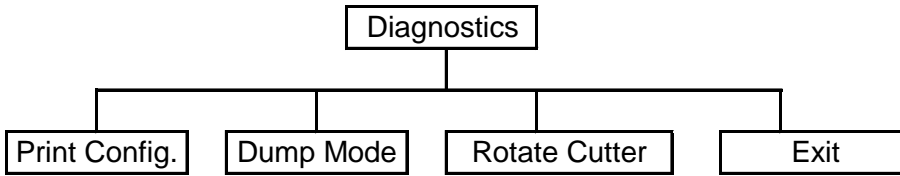

3.3.1 Print Config.

This feature is used to print current printer configuration to the label. On the configuration printout, there is a print head test pattern, which is useful for checking if there is any dot damage on the print head heater element. (Please refer to section 4.2.)

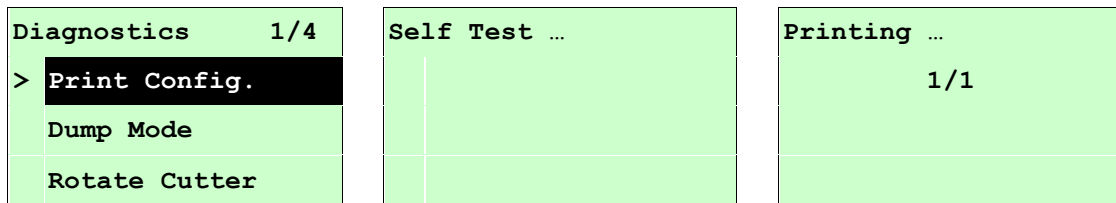

3.3.2 Dump Mode

Captures the data from the communications port and prints out the data received by printer. In the dump mode, all characters will be printed in 2 columns as following. The left side characters are received from your system and right side data are the corresponding hexadecimal value of the characters. It allows users or engineers to verify and debug the program. (Please refer to section 4.2)

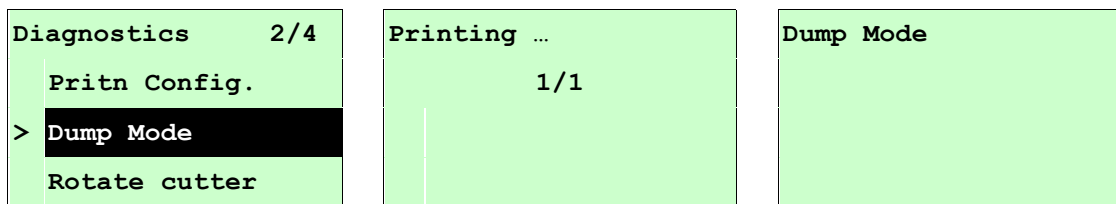

Note:

1. *Dump mode requires 4" wide paper width.*
2. *Turn off / on the power to resume printer for normal printing.*
3. *Press FEED button to back to the previous menu.*

3.3.3 Rotate Cutter



In case paper is jammed in the cutter, this feature can rotate the cutter blade forward or reverse direction, which is helpful to remove the jammed paper easily from the cutter.

Diagnosics 3/4	UP: Fwd.
Print Config.	DOWN: Rev.
Dump Mode	
> Rotate Cutter	MENU: Exit

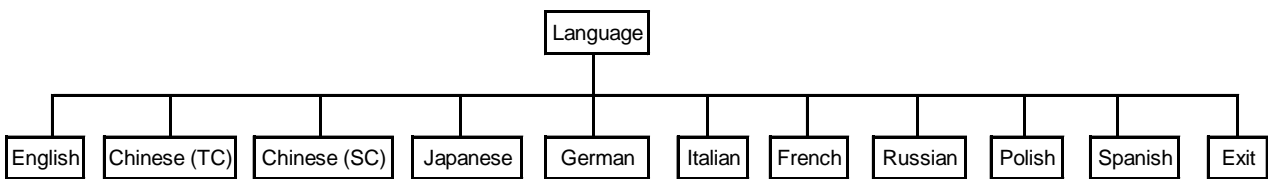
3.4 Language



This option is used to setup the language on LCD display.

Press **UP**  and **DOWN**  buttons to scroll the cursor to desire language and press **SELECT** button to select this option. Press  **MENU** key to cancel the setting and return to the previous menu. The default language setting is English.

3.5 Service

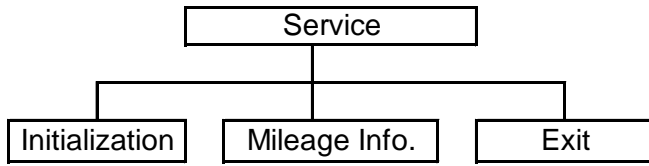

This feature is used to restore printer settings to defaults and display printer mileage information.

3.5.1 Initialization

<pre>Service 1/3 > Initialization Mileage Info. Exit</pre>	<pre>Initialization SELECT YES MENU NO</pre>	<pre>Initializing ...</pre>
--	---	-----------------------------

The printer settings are restored to defaults once printer is initialized. (Please refer to section 4.2 for default settings.)

Note :

When printer initialization is done, please calibrate the gap or black mark sensor before printing.

3.5.2 Mileage Info.

Use this option to check the printed mileage (displayed in meter).

<pre>Service 1/3 Initialization > Mileage Info. Exit</pre>	<pre>Mileage: (m) xxxx Labels: (pcs.) xxxxxx</pre>
--	--

4. Diagnostic Tool

TSC's Diagnostic Utility is an integrated tool incorporating features that enable you to explore a printer's settings/status; change a printer's settings; download graphics, fonts and firmware; create a printer bitmap font; and send additional commands to a printer. With the aid of this powerful tool, you can review printer status and settings in an instant, which makes it much easier to troubleshoot problems and other issues.

4.1 Start the Diagnostic Tool

1. Double click on the Diagnostic tool icon  `DiagTool.exe` to start the software.
2. There are four features (Printer Configuration, File Manager, Bitmap Font Manager, Command Tool) included in the Diagnostic utility.

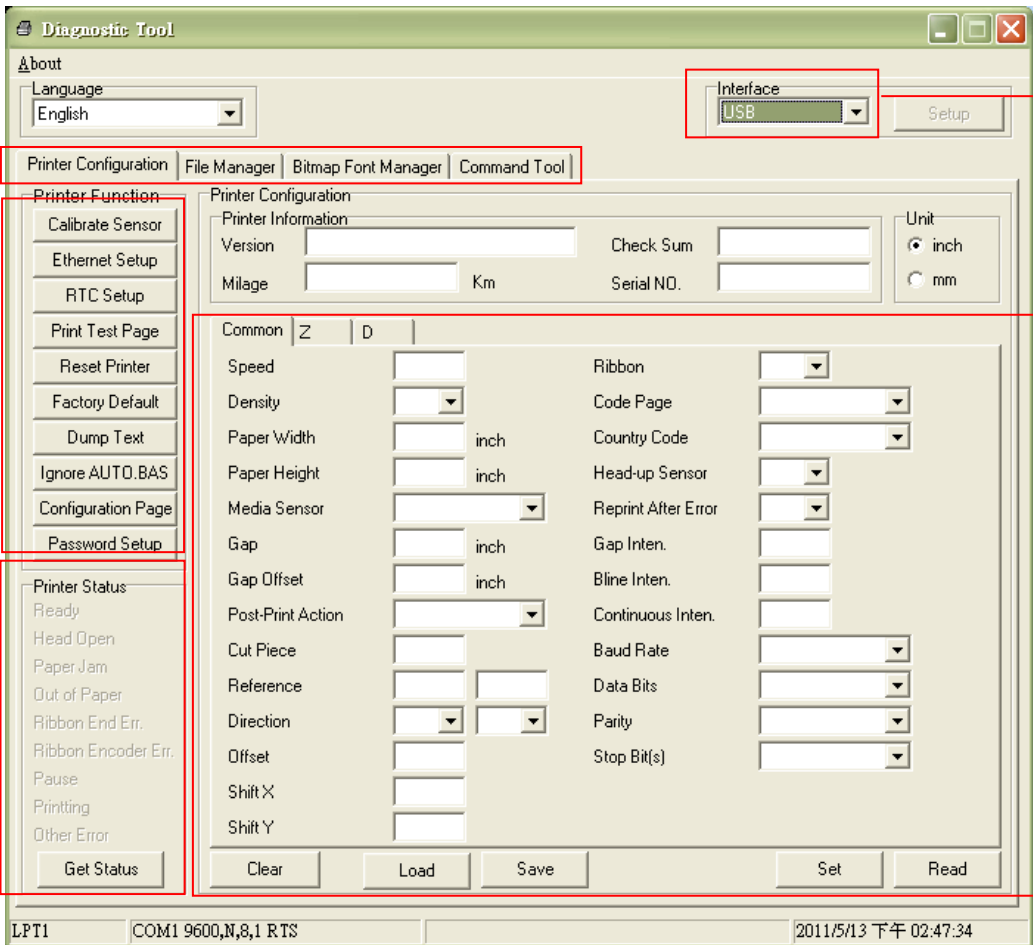

The screenshot shows the 'Diagnostic Tool' window with several red boxes and labels pointing to specific features:

- Features tab:** Points to the 'Printer Configuration' tab in the top navigation bar.
- Interface:** Points to the 'Interface' dropdown menu, which is currently set to 'USB'.
- Printer functions:** Points to the 'Printer Function' sidebar on the left, which includes buttons for 'Calibrate Sensor', 'Ethernet Setup', 'RTC Setup', 'Print Test Page', 'Reset Printer', 'Factory Default', 'Dump Text', 'Ignore AUTO.BAS', 'Configuration Page', and 'Password Setup'.
- Printer Status:** Points to the 'Printer Status' sidebar on the left, which lists status indicators like 'Ready', 'Head Open', 'Paper Jam', etc., and a 'Get Status' button.
- Printer setup:** Points to the main configuration area on the right, which includes fields for 'Printer Information' (Version, Milage, Check Sum, Serial NO.), 'Common' settings (Speed, Density, Paper Width, Paper Height, Media Sensor, Gap, Gap Offset, Post-Print Action, Cut Piece, Reference, Direction, Offset, Shift X, Shift Y), and 'Printer Configuration' settings (Ribbon, Code Page, Country Code, Head-up Sensor, Reprint After Error, Gap Inten., Bline Inten., Continuous Inten., Baud Rate, Data Bits, Parity, Stop Bit(s)).

At the bottom of the window, the status bar shows 'LPT1', 'COM1 9600,N,8,1 RTS', and the date/time '2011/5/13 下午 02:47:34'.

4.2 Printer Function

1. Select the PC interface connected with bar code printer.
2. Click the “Printer Function” button to setup.
3. The detail functions in the Printer Function Group are listed as below.

	Function	Description
Printer Function		
Calibrate Sensor	Calibrate Sensor	Calibrate the sensor specified in the Printer Setup group media sensor field
Ethernet Setup	Ethernet Setup	Setup the IP address, subnet mask, gateway for the on board Ethernet
RTC Setup	RTC Setup	Synchronize printer Real Time Clock with PC
Print Test Page	Print Test Page	Print a test page
Reset Printer	Reset Printer	Reboot printer
Factory Default	Factory Default	Initialize the printer and restore the settings to factory default.
Dump Text	Dump Text	To activate the printer dump mode.
Ignore AUTO.BAS	Ignore AUTO.BAS	Ignore the downloaded AUTO.BAS program
Configuration Page	Configuration Page	Print printer configuration
Password Setup	Password Setup	Set the password to protect the settings

The factory default settings are listed as below.

Parameter	Default setting
Speed	ME240: 5 IPS (127 mm/sec) ME340: 3 IPS (76.2 mm/sec)
Density	8
Label width	4.00” (101.6 mm)
Label height	4.00” (101.6 mm)
Sensor type	Gap sensor
Gap setting	0.12” (3.0 mm)
Print direction	0
Reference point	0,0 (upper left corner)
Offset	0
Print mode	Batch mode
Serial port settings	9600 bps, none parity, 8 data bits, 1 stop bit
Code page	850
Country code	001
Clear flash memory	No
Shift X	0
Shift Y	0
Gap sensor	3 (Will be reset. Need to re-calibrate the gap sensor)

sensitivity	
Blinc sensor	2 (Will be reset. Need to re-calibrate the gap sensor)
sensitivity	
Language	English
IP address	DHCP

Configuration Page

Self-test printout	
<pre> PRINTER INFO. XXXXX Version: X.XX EZ SERIAL NO.: XXXXXXXXXXXX MILAGE(m): 25 CHECKSUM: 07B575A3 SERIAL PORT: 9800,N,8,1 CODE PAGE: 850 COUNTRY CODE: 001 SPEED: 3 INCH DENSITY: 8.0 SIZE: 4.00 , 2.90 BLINE: 0.12 , 0.00 TRANSPARENCE: 2 HOST NAME: PS-600002 MAC ADDRESS: 00-1B-82-60-00-02 DHCP ENABLED: YES IP ADDRESS: 0.0.0.0 SUBNET MASK: 0.0.0.0 DEFAULT GATEWAY: 0.0.0.0 ***** FILE LIST: DRAM FILE: 0 FILE(S) FLASH FILE: 0 FILE(S) PHYSICAL DRAM: XXXX KBYTES AVAILABLE DRAM: XXX KBYTES FREE PHYSICAL FLASH: XXXX KBYTES AVAILABLE FLASH: XXXX KBYTES FREE END OF FILE LIST ***** </pre>	<p>Printer model name & Main board firmware version</p> <p>Printer serial number</p> <p>Printed mileage</p> <p>Main board firmware checksum</p> <p>Serial port setting</p> <p>Code page</p> <p>Country code</p> <p>Print speed</p> <p>Print darkness</p> <p>Label size (width, height)</p> <p>Black mark or gap size (vertical gap, offset)</p> <p>Sensor sensitivity</p> <p>} Ethernet settings information (option)</p> <p>} File management information</p> <p>Print head test pattern</p>

Self-test printout (with printer firmware V7.0 and later version)

```

-----
SYSTEM INFORMATION
-----
MODEL: XXXXXX
FIRMWARE: X.XX
CHECKSUM: XXXXXXXX
S/N: XXXXXXXXXXXX
TCF: NO
DATE: 1970/01/01
TIME: 00:04:18
NON-RESET: 110 m (TPH)
RESET: 110 m (TPH)
NON-RESET: 0 (CUT)
RESET: 0 (CUT)
-----
    
```

Model name
 F/W version
 Firmware checksum
 Printer S/N
 TSC configuration file
 System date
 System time
 Printed mileage (meter)
 Cutting counter

```

-----
PRINTING SETTING
-----
SPEED: 5 IPS
DENSITY: 8.0
WIDTH: 4.00 INCH
HEIGHT: 4.00 INCH
GAP: 0.00 INCH
INTENSION: 5
CODEPAGE: 850
COUNTRY: 001
-----
    
```

Print speed (inch/sec)
 Print darkness
 Label size (inch)
 Gap distance (inch)
 Gap/black mark sensor intension
 Code page
 Country code

```

-----
Z SETTING
-----
DARKNESS: 16.0
SPEED: 4 IPS
WIDTH: 4.00 INCH
TILDE: 7EH (~)
CARET: 5EH (^)
DELIMITER: 2CH (,)
POWER UP: NO MOTION
HEAD CLOSE: NO MOTION
-----
    
```

ZPL setting information
 Print darkness
 Print speed (inch/sec)
 Label size
 Control prefix
 Format prefix
 Delimiter prefix
 Printer power up motion
 Printer head close motion

Note:
 ZPL is emulating for Zebra® language.

```

-----
RS232 SETTING
-----
BAUD: 9600
PARITY: NONE
DATA BIT: 8
STOP BIT: 1
-----
    
```

RS232 serial port configuration

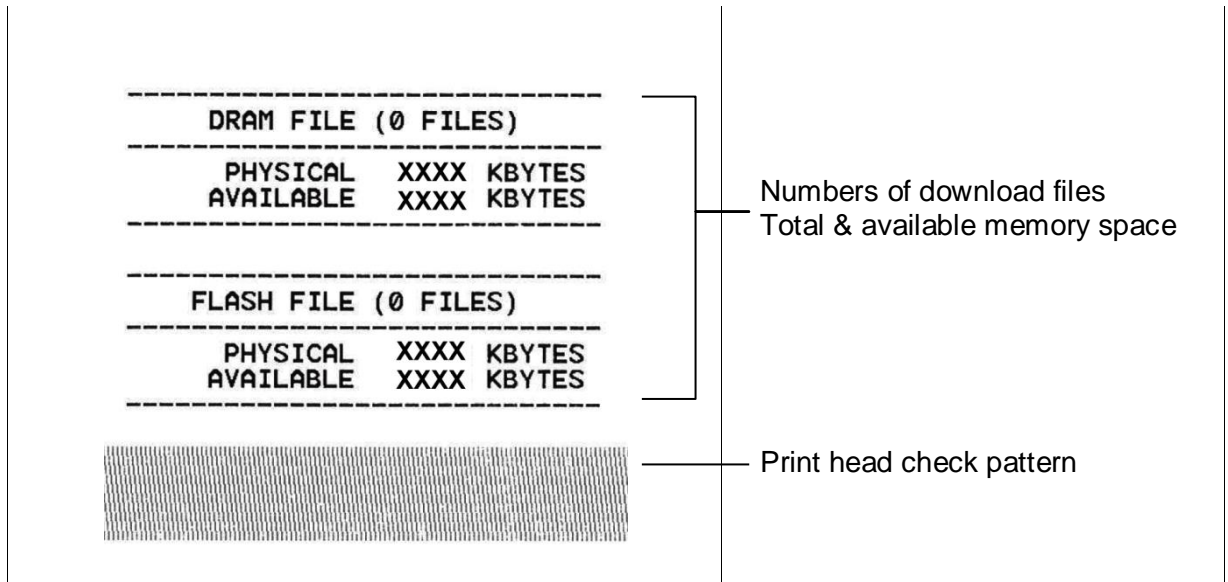

Dump Text

```
DOWNLOA 0D 0A 44 4F 57 4E 4C 4F 4I
D „TEST2. 44 20 22 54 45 53 54 32 2E
DAT“,5,CL 44 41 54 22 2C 35 2C 43 4C
S DOWNLO 53 0D 0A 44 4F 57 4E 4C 4F
AD F,„TES 41 44 20 46 2C 22 54 45 53
T4.DAT“,5 54 34 2E 44 41 54 22 2C 35
,CLS DOW 2C 43 4C 53 0D 0A 44 4F 57
NLOAD „TE 4E 4C 4F 41 44 20 22 54 45
ST2.DAT“, 53 54 32 2E 44 41 54 22 2C
5,CLS DO 35 2C 43 4C 53 0D 0A 44 4F
WNLOAD F, 57 4E 4C 4F 41 44 20 46 2C
„TEST4.DA 22 54 45 53 54 34 2E 44 41
T“,5,CLS 54 22 2C 35 2C 43 4C 53 0D
DOWNLOAD 0A 44 4F 57 4E 4C 4F 41 44
„TEST2.D 20 22 54 45 53 54 32 2E 44
AT“,5,CLS 41 54 22 2C 35 2C 43 4C 53
DOWNLOA 0D 0A 44 4F 57 4E 4C 4F 4I
D F,„TEST 44 20 46 2C 22 54 45 53 54
4.DAT“,5, 34 2E 44 41 54 22 2C 35 2C
CLS 43 4C 53 0D 0A
```

ASCII Data

Hexadecimal data related to left
column of ASCII data

Note:

- 1. Dump mode requires 4" wide paper width.**
- 2. Turn off / on the power to resume printer for normal printing.**

For more information about Diagnostic Tool, please refer to the diagnostic utility quick start guide in the CD disk \ Utilities directory.

5 Setting Ethernet by Diagnostic Utility (Option)

The Diagnostic Utility is enclosed in the CD disk \Utilities directory. Users can use Diagnostic Tool to setup the Ethernet by RS-232, USB and Ethernet interfaces. The following contents will instruct users how to configure the Ethernet by these three interfaces.

5.1 Using USB interface to setup Ethernet interface

1. Connect the USB cable between the computer and the printer.
2. Turn on the printer power.
3. Start the Diagnostic Utility by double clicking on the  **DiagTool.exe** icon.

Note: This utility works with printer firmware V6.00 and later versions.

4. The Diagnostic Utility default interface setting is USB interface. If USB interface is connected with printer, no other settings need to be changed in the interface field.

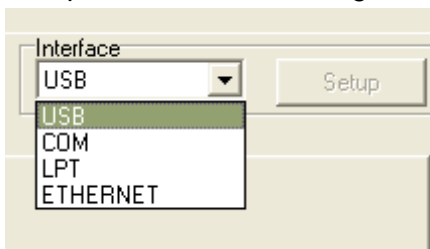

5. Click on the “Ethernet Setup” button from “Printer Function” group in Printer Configuration tab to setup the IP address, subnet mask and gateway for the on board Ethernet.

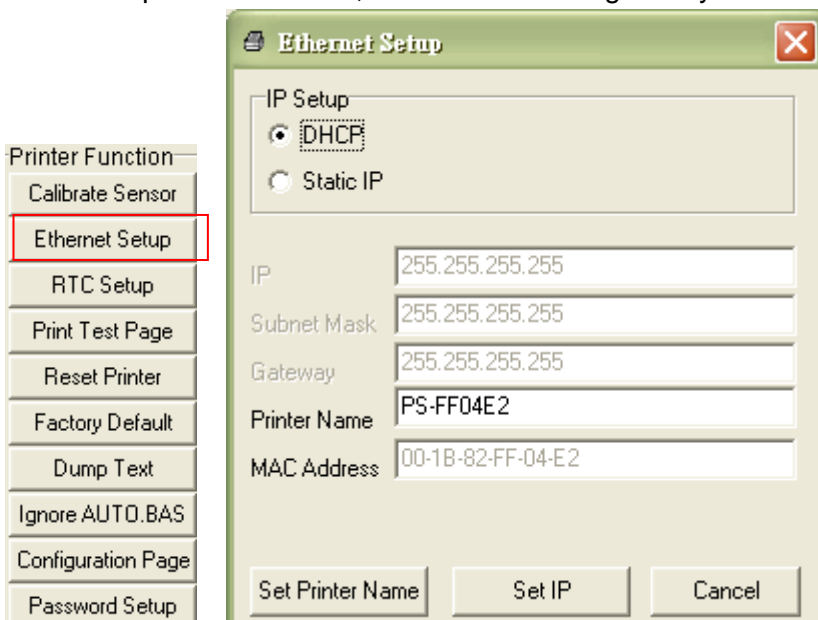

5.2 Using RS-232 interface to setup Ethernet interface

1. Connect the computer and the printer with a RS-232 cable.
2. Turn on the printer power.
3. Start the Diagnostic Utility by double clicks on the  icon.

Note: This utility works with printer firmware V6.00 and later versions.

4. Select “COM” as interface then click on the “Setup” button to setup the serial port baud rate, parity check, data bits, stop bit and flow control parameters.

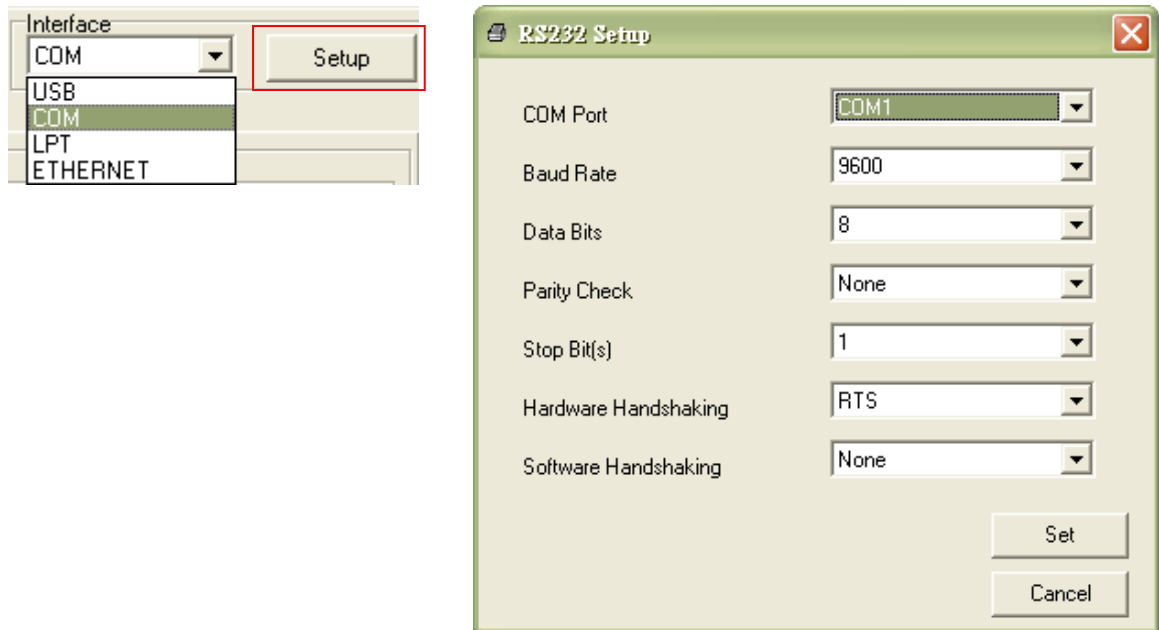

5. Click on the “Ethernet Setup” button from printer function of Printer Configuration tab to setup the IP address, subnet mask and the gateway for the on board Ethernet.

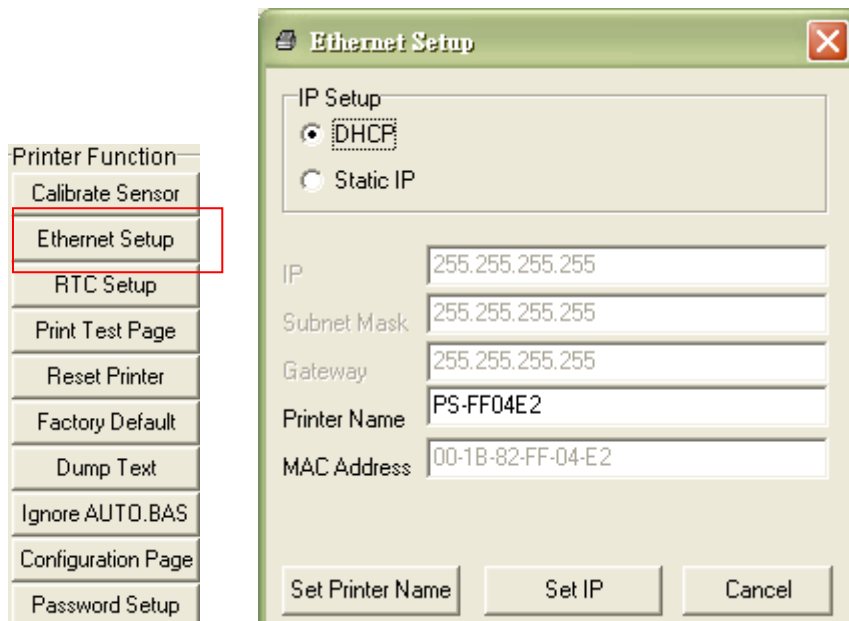

5.3 Using Ethernet interface to setup Ethernet interface

1. Connect the computer and the printer to the LAN.
2. Turn on the printer power.
3. Start the Diagnostic Utility by double clicks on the  icon.

Note: This utility works with printer firmware V6.00 and later versions.

4. Select “Ethernet” as the interface then click on the “Setup” button to setup the IP address, subnet mask and gateway for the on board Ethernet.

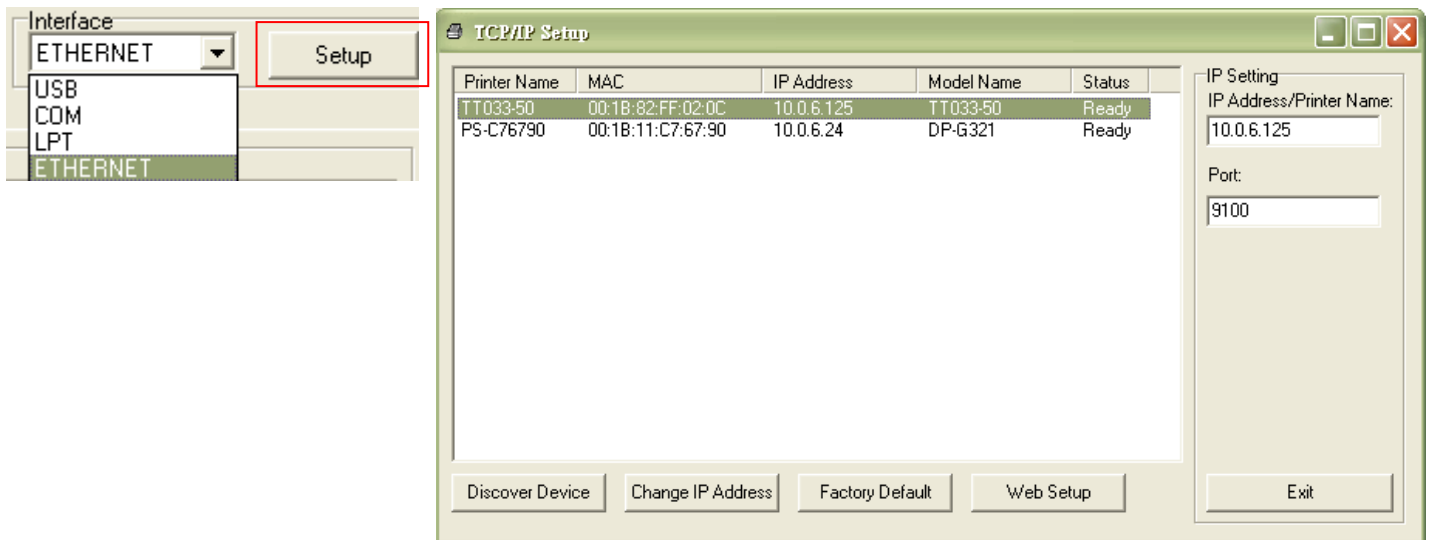

5. Click the “Discover Device” button to explore the printers that exist on the network.
6. Select the printer in the left side of listed printers, the correspondent IP address will be shown in the right side “IP address/Printer Name” field.
7. Click “Change IP Address” to configure the IP address obtained by DHCP or static.

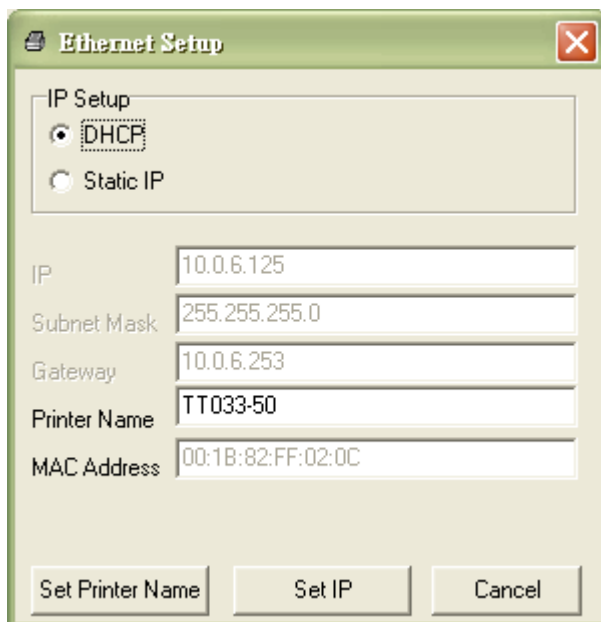

The default IP address is obtained by DHCP. To change the setting to static IP address, click “Static IP” radio button then enter the IP address, subnet mask and gateway. Click “Set IP” to take effect the settings.

Users can also change the “Printer Name” by another model name in this fields then click “Set Printer Name” to take effect this change.

Note: After clicking the “Set Printer Name” or “Set IP” button, printer will reset to take effect the settings.

8. Click “Exit” button to exit the Ethernet interface setup and go back to Diagnostic Tool main screen.

Factory Default button

This function will reset the IP, subnet mask, gateway parameters obtained by DHCP and reset the printer name.

Web setup button

Except to use the Diagnostic Utility to setup the printer, you can also explore and configure the printer settings and status or update the firmware with the IE or Firefox web browser. This feature provides a user friendly setup interface and the capability to manage the printer remotely over a network.

6. Troubleshooting

6.1 Common Problems

The following guide lists the most common problems that may be encountered when operating this bar code printer. If the printer still does not function after all suggested solutions have been invoked, please contact the Customer Service Department of your purchased reseller or distributor for assistance.

Problem	Possible Cause	Recovery Procedure						
Power indicator does not illuminate	* The power cord is not properly connected.	* Plug the power cord in printer and outlet. * Switch the printer on.						
- The printer status from DiagTool shows " Head Open ". - The LCD shows " Carriage Open ".	* The printer carriage is open.	* Please close the print carriage.						
- The printer status from DiagTool shows " Ribbon End Err. " Or " Ribbon Encoder Err. " - The LCD shows " No Ribbon ".	* Running out of ribbon. * The ribbon is installed incorrectly.	* Supply a new ribbon roll. * Please refer to the steps on section 2.5 to reinstall the ribbon.						
- The printer status from DiagTool shows " Out of Paper ". - The LCD shows " No Paper ".	* Running out of label. * The label is installed incorrectly. * Gap/black mark sensor is not calibrated.	* Supply a new label roll. * Please refer to the steps on section 2.6 to reinstall the label roll. * Calibrate the gap/black mark sensor.						
- The printer status from DiagTool shows " Paper Jam ". - The LCD shows " Paper Jam ".	* Gap/black mark sensor is not set properly. * Make sure label size is set properly. * Labels may be stuck inside the printer mechanism.	* Calibrate the gap/black mark sensor. * Set label size correctly.						
- The LCD shows " Take Label ".	* Peel-off function is enabled.	* If the peel-off module is installed, please remove the label. * If there is no peel-off module in front of the printer, please switch off the printer and install it. * Check if the connector is plugging correctly.						
- The LCD shows as below: <table border="1" data-bbox="242 1783 513 1930"> <tr> <td>UP:</td> <td>Fwd.</td> </tr> <tr> <td>DOWN:</td> <td>Rev.</td> </tr> <tr> <td>MENU:</td> <td>Exit</td> </tr> </table>	UP:	Fwd.	DOWN:	Rev.	MENU:	Exit	* Cutter jam. * There is no cutter installed on the printer. * Cutter PCB is damaged.	* If the cutter module is installed, please press UP or DOWN key to rotate the cutter up or down to make the knife back to the right position. * Remove the label. * Make sure the thickness of label is less than 280 g/m2. * Replace a cutter PCB.
UP:	Fwd.							
DOWN:	Rev.							
MENU:	Exit							

<p style="text-align: center;">Not Printing</p>	<ul style="list-style-type: none"> * Cable is not well connected to serial or USB interface or parallel port. * The serial port cable pin configuration is not pin to pin connected. 	<ul style="list-style-type: none"> * Re-connect cable to interface. * If using serial cable, <ul style="list-style-type: none"> - Please replace the cable with pin to pin connected. - Check the baud rate setting. The default baud rate setting of printer is 9600,n,8,1. * If using the Ethernet cable, <ul style="list-style-type: none"> - Check if the Ethernet RJ-45 connector green LED is lit on. - Check if the Ethernet RJ-45 connector amber LED is blinking. - Check if the printer gets the IP address when using DHCP mode. - Check if the IP address is correct when using the static IP address. - Wait a few seconds let the printer get the communication with the server then check the IP address setting again. * Chang a new cable. * Ribbon and media are not compatible. * Verify the ribbon-inked side. * Reload the ribbon again. * Clean the printhead. * The print density setting is incorrect. * Printhead's harness connector is not well connected with printhead. Turn off the printer and plug the connector again. * Check your program if there is a command PRINT at the end of the file and there must have CRLF at the end of each command line.
<p style="text-align: center;">Memory full (FLASH / DRAM)</p>	<ul style="list-style-type: none"> * The space of FLASH/DRAM is full. 	<ul style="list-style-type: none"> * Delete unused files in the FLASH/DRAM. * The max. numbers of DRAM is 256 files. * The max. user addressable memory space of DRAM is 256KB. * The max. numbers of file of FLASH is 256 files. * The max. user addressable memory space of FLASH is 2560KB.
<p style="text-align: center;">SD card is unable to use</p>	<ul style="list-style-type: none"> * SD card is damaged. * SD card doesn't insert correctly. * Use the non-approved SD card manufacturer. 	<ul style="list-style-type: none"> * Use the supported capacity SD card. * Insert the SD card again. * The supported SD card spec and the approved SD card manufacturers, please refer to section 2.2.3.

<p style="text-align: center;">Poor Print Quality</p>	<ul style="list-style-type: none"> * Ribbon and media is loaded incorrectly * Dust or adhesive accumulation on the print head. * Print density is not set properly. * Printhead element is damaged. * Ribbon and media are incompatible. * The printhead pressure is not set properly. 	<ul style="list-style-type: none"> * Reload the supply. * Clean the printhead. * Clean the platen roller. * Adjust the print density and print speed. * Run printer self-test and check the print head test pattern if there is dot missing in the pattern. * Change proper ribbon or proper label media. * Adjust the printhead pressure adjustment knob. <ul style="list-style-type: none"> - If the left side printout is too light, please adjust the left side pressure adjustment knob to the higher index (higher pressure). If the pressure adjustment knob has been adjust to index "5" and the poor print quality is still at the left side of the printout, pressure adjustment knob to index "1" and use the Z-axis adjustment knob to fine tune the pressure. - If the right side printout is too light, please adjust the right side pressure adjustment knob to the higher index (higher pressure) If the pressure adjustment knob has been adjust to index "5" and the poor print quality is still at the right side of the printout, pressure adjustment knob to index "1" and use the Z-axis adjustment knob to fine tune the pressure. * The release lever does not latch the printhead properly.
<p style="text-align: center;">LCD panel is dark but the LEDs are light</p>	<ul style="list-style-type: none"> * The printer initialization is unsuccessful. 	<ul style="list-style-type: none"> * Turn OFF and ON the printer again. * Initialize the printer.
<p style="text-align: center;">LCD panel is dark and LEDs are lit on, but the label is feeding forward</p>	<ul style="list-style-type: none"> * The LCD panel harness connector is loose. 	<ul style="list-style-type: none"> * The LCD panel harness connector is plugged upside down.
<p style="text-align: center;">Cutter is not working</p>	<ul style="list-style-type: none"> * The connector is loose. 	<ul style="list-style-type: none"> * Plug in the connect cable correctly.
<p style="text-align: center;">Label feeding is not stable (skew) when printing</p>	<ul style="list-style-type: none"> * The media guide does not touch the edge of the media. 	<ul style="list-style-type: none"> * If the label is moving to the right side, please move the label guide to left. * If the label is moving to the left side, please move the label guide to right.
<p style="text-align: center;">Skip labels when printing</p>	<ul style="list-style-type: none"> * Label size is not specified properly. * Sensor sensitivity is not set properly. * The media sensor is covered with dust. 	<ul style="list-style-type: none"> * Check if label size is setup correctly. * Calibrate the sensor by Auto Gap or Manual Gap options. * Clear the GAP/Black mark sensor by blower.

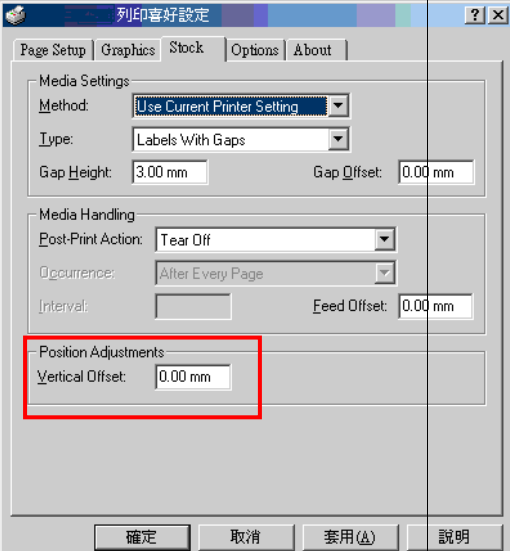
<p>The printing position of small label is incorrect</p>	<ul style="list-style-type: none"> * Media sensor sensitivity is not set properly. * Label size is incorrect. * The parameter Shift Y in the LCD menu is incorrect. * The vertical offset setting in the driver is incorrect. 	<ul style="list-style-type: none"> * Calibrate the sensor sensitivity again. * Set the correct label size and gap size. * Press [MENU] → [SELECT] x3 → [DOWN] x6 → [SELECT] to fine tune the parameter of Shift Y. (Option) * If using the software BarTender, please set the vertical offset in the driver. 
<p>The left side printout position is incorrect</p>	<ul style="list-style-type: none"> * Wrong label size setup. * The parameter Shift X in LCD menu is incorrect. 	<ul style="list-style-type: none"> * Set the correct label size. * Press [MENU] → [SELECT] x 3 → [DOWN] x 5 → [SELECT] to fine tune the parameter of Shift X. (Option)
<p>Missing printing on the left or right side of label</p>	<ul style="list-style-type: none"> * Wrong label size setup. 	<ul style="list-style-type: none"> * Set the correct label size.
<p>RTC time is incorrect when reboot the printer</p>	<ul style="list-style-type: none"> * The battery has run down. 	<ul style="list-style-type: none"> * Check if there is a battery on the main board.
<p>Power and Error LEDs are blinking fast</p>	<ul style="list-style-type: none"> * Power switch OFF and ON too fast. 	<ul style="list-style-type: none"> * Turn off the printer and wait all LEDs are dark, and turn on the printer again.
<p>Wrinkle problem</p>	<ul style="list-style-type: none"> * Printhead pressure is incorrect. * Ribbon installation is incorrect. * Media installation is incorrect. * Print density is incorrect. * Media feeding is incorrect. 	<ul style="list-style-type: none"> * Please refer to the next chapter. * Please set the suitable density to have good print quality. * Make sure the label guide touch the edge of the media guide.
<p>Gray line on the blank label</p>	<ul style="list-style-type: none"> * The print head is dirty. * The platen roller is dirty. 	<ul style="list-style-type: none"> * Clean the printhead. * Clean the platen roller.
<p>Irregular printing</p>	<ul style="list-style-type: none"> * The printer is in Hex Dump mode. * The RS-232 setting is incorrect. 	<ul style="list-style-type: none"> * Turn off and on the printer to skip the dump mode. * Re-set the Rs-232 setting.

6.2 Mechanism Fine Adjustment to Avoid Ribbon Wrinkles

This printer has been fully tested before delivery. There should be no ribbon wrinkle presented on the media for general-purpose printing application. Ribbon wrinkle is related to the media thickness, print head pressure balance, ribbon film characteristics, print darkness setting...etc. In case the ribbon wrinkle happens, please follow the instructions below to adjust the printer parts.

<p>Adjustable Printer Parts</p>		
<p>Symptom</p>	<p>1. Wrinkle happens from label lower left to upper right direction (“ / ”)</p>	<p>2. Wrinkle happens from label lower right to upper left direction (“ \ ”)</p>
<p>Wrinkle Example</p>	<div style="display: flex; justify-content: space-around; align-items: center;"> <div data-bbox="400 1088 703 1464">  </div> <div data-bbox="863 1122 922 1249" style="text-align: center;">  </div> <div data-bbox="767 1301 1011 1357" style="text-align: center;"> <p>Feed direction</p> </div> <div data-bbox="1066 1088 1369 1464">  </div> </div>	

Adjust the print head pressure adjustment knob

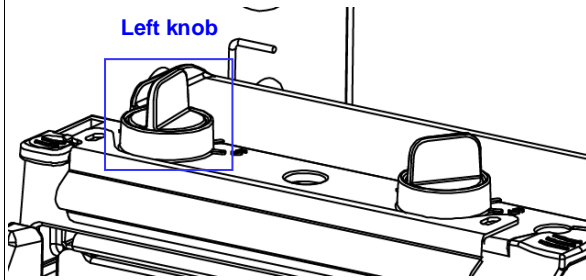

The print head pressure adjustment knob has 5 levels of settings. Clockwise direction adjustment is to increase the print head pressure. Counter Clockwise adjustment can decrease the print head pressure.

If the wrinkle on the label starts from the lower left side to upper right side, please do following adjustment.

1. Decrease the right side print head pressure adjustment knob setting 1 level per each adjustment then print the label again to check if wrinkle is gone.
2. If the right side print head adjustment knob setting has been set to index 1 (the lowest pressure index), please increase the left side print head pressure.
3. If the wrinkle can't be avoided, please contact the Customer Service Department of your purchased reseller or distributor for service.

Adjust the print head pressure adjustment knob

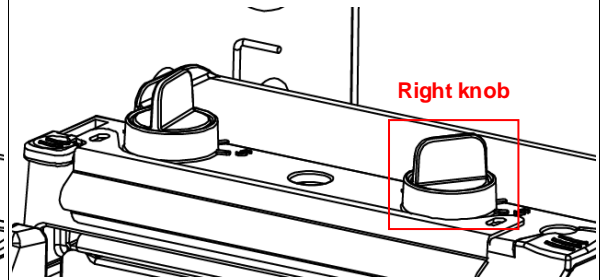

The print head pressure adjustment knob has 5 levels of settings. Clockwise direction adjustment is to increase the print head pressure. Counter Clockwise adjustment can decrease the print head pressure.

If the wrinkle on the label starts from the lower right side to upper left side, please do following adjustment.

1. Decrease the left side print head pressure adjustment knob setting 1 level per each adjustment then print the label again to check if wrinkle is gone.
2. If the left side print head adjustment knob level has been set to index 1 (the lowest index), please increase the right side print head pressure.
3. If the wrinkle can't be avoided, please contact the Customer Service Department of your purchased reseller or distributor for service.

7. Maintenance

This session presents the clean tools and methods to maintain your printer.

1. Please use one of following material to clean the printer.

- Cotton swab
- Lint-free cloth
- Vacuum / Blower brush
- 100% ethanol

2. The cleaning process is described as following,

Printer Part	Method	Interval
Print Head	1. Always turn off the printer before cleaning the print head. 2. Allow the print head to cool for a minimum of one minute. 3. Use a cotton swab and 100% ethanol to clean the print head surface.	Clean the print head when changing a new label roll
Platen Roller	1. Turn the power off. 2. Rotate the platen roller and wipe it thoroughly with 100% ethanol and a cotton swab, or lint-free cloth.	Clean the platen roller when changing a new label roll
Tear Bar/Peel Bar	Use the lint-free cloth with 100% ethanol to wipe it.	As needed
Sensor	Compressed air or vacuum	Monthly
Exterior	Wipe it with water-dampened cloth	As needed
Interior	Brush or vacuum	As needed

Note:

- Do not touch printer head by hand. If you touch it careless, please use ethanol to clean it.
- Please use 100% Ethanol. DO NOT use medical alcohol, which may damage the printer head.
- Regularly clean the print head and supply sensors once change a new ribbon to keep printer performance and extend printer life.

Revise History

Date	Content	Editor
2011/11/16	Modify the section 4.2	Camille
2011/12/2	Modify the section 2.3.2	Camille
2011/12/6	Modify the “Agency Compliance and Approvals”	Camille
2013/4/2	Modify section 1.2.2 (cutter spec) Modify section 4.2 (V7.0 F/W self test) Add TSC YouTube web address	Camille
2014/11/5	Modify the “Agency Compliance and Approvals”	Camille
2017/6/8	Modify the list of Agency Compliance and Approvals	Kate
2017/8/24	Modify section 1.2.2 (cutter spec)	Camille
2018/1/22	Modify the “Agency Compliance and Approvals”	Kate
2019/4/19	Modify section 1.2.2 (Regular guillotine cutter spec)	Kate
2019/10/1	Modify CCC certification logo	Kate



TSC Auto ID Technology Co., Ltd.

Corporate Headquarters

9F., No.95, Minquan Rd., Xindian Dist.,
New Taipei City 23141, Taiwan (R.O.C.)

TEL: +886-2-2218-6789

FAX: +886-2-2218-5678

Web site: www.tscprinters.com

E-mail: printer_sales@tscprinters.com
tech_support@tscprinters.com

Li Ze Plant

No.35, Sec. 2, Ligong 1st Rd., Wujie Township,
Yilan County 26841, Taiwan (R.O.C.)

TEL: +886-3-990-6677

FAX: +886-3-990-5577